

RECEIVED BY
PORT EVERGLADES DEPT.
BUSINESS ADMINISTRATIVE
2017 FEB 14 PM 4:02

PORT EVERGLADES FRANCHISE APPLICATION

An application will not be deemed complete and ready for processing until all required documents and fees are received.

A separate application must be filed for each type of franchise applied for.

FRANCHISE TYPE

CHECK ONE

STEAMSHIP AGENT

STEVEDORE

CARGO HANDLER

TUGBOAT & TOWING

VESSEL BUNKERING

VESSEL OILY WASTE REMOVAL

VESSEL SANITARY WASTE WATER REMOVAL

MARINE TERMINAL SECURITY

MARINE TERMINAL SECURITY

FIREARMS CARRYING SECURITY PERSONNEL

NON-FIREARMS CARRYING SECURITY PERSONNEL

Note: Applicant is the legal entity applying for the franchise. If the Applicant is granted the franchise, it will be the named franchisee. All information contained in this application shall apply only to the Applicant, and not to any parent, affiliate, or subsidiary entities.

Applicant's

Name Continental Florida Materials Inc.

(Name as it appears on the certificate of incorporation, charter, or other legal documentation as applicable, evidencing the legal formation of the Applicant)

Applicant's Business Address 2600 Eisenhower Boulevard, Port Everglades, FL 33316

Number /

Street

City/State/Zip

Phone # (954) 523-8442

E-mail address carlos.gonzalez @ lehighhanson.com

Fax #: (954) 523- 056

Name of the person authorized to bind the Applicant (Person's signature must appear on Page 13.)

Name Phil Detwiler

Title Vice President and General Manager

Business Address 400 Riverhills Business Park, Suite 437, Birmingham, AL 35242

Number /

Street

City/State/Zip

Phone # (205) 968-5803

E-mail address phil.detwiler @ lehighhanson.com

Fax #: () _____

Provide the Name and Contact Information of Applicant's Representative to whom questions about this application are to be directed (if different from the person authorized to bind the Applicant):

Representative's Name Carlos Gonzalez

Representative's Title Terminal Manager

Representative's Business Address 2600 Eisenhower Boulevard, Port Everglades, FL 33316

Number /

Street

City/State/Zip

Representative's E-mail address carlos.gonzalez @ lehighhanson.com

PLEASE COMPLETE THIS APPLICATION AND LABEL ALL REQUIRED BACKUP DOCUMENTATION TO CLEARLY IDENTIFY THE SECTION OF THE APPLICATION TO WHICH THE DOCUMENTATION APPLIES (I.E., SECTION A, B, C, etc.).

Section A

1. List the name(s) of Applicant's officers, including, CEO, COO, CFO, director(s), member(s), partner(s), shareholder(s), principal(s), employee(s), agents, and local representative(s) active in the management of the Applicant.

Officers:

Title President

✓ First Name Glenn Middle Name T.
Last Name Heller
Business Street Address 300 E. John Carpenter Freeway, Suite 1645
City, State, Zip Code Irving, TX 75062
Phone Number (972) 653-5500 Fax Number ()
Email Address glenn.heller @ lehighhanson.com

Title Vice President and Chief Financial Officer

✓ First Name Henner Middle Name
Last Name Boettcher
Business Street Address 300 E. John Carpenter Freeway, Suite 1645
City, State, Zip Code Irving, TX 75062
Phone Number (972) 653-5500 Fax Number ()
Email Address henner.boettcher @ lehighhanson.com

Title Vice President and Secretary

✓ First Name Carol Middle Name L.
Last Name Lowry
Business Street Address
City, State, Zip Code 300 E. John Carpenter Freeway, Suite 1645
Phone Number (972) 653-5500 Fax Number ()
Email Address carol.lowry @ lehighhanson.com

Title Vice President and General Manager

First Name Phil Middle Name
Last Name Detwiler
Business Street Address 400 Riverhills Business Park, Suite 437
City, State, Zip Code Birmingham, AL 35242
Phone Number (205) 968-5803 Fax Number (205) 601-6990
Email Address phil.detwiler @ lehighhanson.com

Attach additional sheets if necessary.

2. RESUMES: Provide a resume for each officer, director, member, partner, shareholder, principal, employee, agent, and local representative(s) active in the management of the Applicant, as listed above.

PLEASE COMPLETE THIS APPLICATION AND LABEL ALL REQUIRED BACKUP DOCUMENTATION TO CLEARLY IDENTIFY THE SECTION OF THE APPLICATION TO WHICH THE DOCUMENTATION APPLIES (I.E....., SECTION A, B, C, etc.).

Section A

1. List the name(s) of Applicant's officers, including, CEO, COO, CFO, director(s), member(s), partner(s), shareholder(s), principal(s), employee(s), agents, and local representative(s) active in the management of the Applicant.

Officers:

Title Director and Chairman
First Name Jonathan Middle Name P
Last Name Morrish
Business Street Address 300 E. John Carpenter Freeway, Suite 1645
City, State, Zip Code Irving, TX 75062
Phone Number (972) 653-5500 Fax Number ()
Email Address jonathan.morrish @ lehighhanson.com .

Title Director, Vice President and Chief Financial Officer
First Name Henner Middle Name
Last Name Boettcher
Business Street Address 300 E. John Carpenter Freeway, Suite 1645
City, State, Zip Code Irving, TX 75062
Phone Number (972) 653-5500 Fax Number ()
Email Address henner.boettcher @ lehighhanson.com .

Title Director and President
First Name Glenn Middle Name
Last Name Heller
Business Street Address 300 E. John Carpenter Freeway, Suite 1645
City, State, Zip Code Irving, TX 75062
Phone Number (972) 653-5500 Fax Number ()
Email Address glenn.heller @ lehighhanson.com .

Title Vice President and Secretary
First Name Carol Middle Name L
Last Name Lowry
Business Street Address 300 E. John Carpenter Freeway, Suite 1645
City, State, Zip Code Irving, TX 75062
Phone Number (972) 653-5500 Fax Number ()
Email Address carol.lowry @ lehighhanson.com .

Attach additional sheets if necessary.

2. RESUMES: Provide a resume for each officer, director, member, partner, shareholder, principal, employee, agent, and local representative(s) active in the management of the Applicant, as listed above.

Section A.1

Additional Officers:

Rebecca Robbins, Treasurer
300 E. John Carpenter Freeway, Suite 1645
Irving, TX 75062
Phone: (972) 653-5500
E-Mail Address: rebecca.robbins@lehighhanson.com

Thaddius Haas, Assistant Secretary
300 E. John Carpenter Freeway, Suite 1645
Irving, TX 75062
Phone: (972) 653-5500
E-Mail Address: thaddius.haas@lehighhanson.com

Amy Yi, Assistant Secretary
300 E. John Carpenter Freeway, Suite 1645
Irving, TX 75062
Phone: (972) 653-5500
E-Mail Address: amy.yi@lehighhanson.com

Section B

1. Place checkmark to describe the Applicant:
() Sole Proprietorship (X) Corporation () Partnership () Joint Venture () Limited Liability Company
2. Provide copies of the documents filed at the time the Applicant was formed including Articles of Incorporation (if a corporation); Articles of Organization (if an LLC); or Certificate of Limited Partnership or Limited Liability Limited Partnership (if a partnership). If the Applicant was not formed in the State of Florida, provide a copy of the documents demonstrating that the Applicant is authorized to conduct business in the State of Florida.

Section C

1. Has there been any change in the ownership of the Applicant within the last five (5) years? (e.g., any transfer of interest to another party)
Yes___ No X If "Yes," please provide details in the space provided. Attach additional sheets if necessary.
2. Has there been any name change of the Applicant or has the Applicant operated under a different name within the last five (5) years?
Yes___ No X If "Yes," please provide details in the space provided, including: Prior name(s) and Date of name change(s) filed with the State of Florida's Division of Corporations or other applicable state agency. Attach additional sheets if necessary.
3. Has there been any change in the officers, directors, executives, partners, shareholders, or members of the Applicant within the past five (5) years?
Yes X No___ If "Yes," please provide details in the space provided, including:
Prior officers, directors, executives, partners, shareholders, members
Name(s) See attached Certificate of Assistant Secretary
New officers, directors, executives, partners, shareholders, members
Name(s) See attached Certificate of Assistant Secretary
Also supply documentation evidencing the changes including resolution or minutes appointing new officers, list of new principals with titles and contact information, and effective date of changes. Attach additional sheets if necessary.

Section D

Provide copies of all fictitious name registrations filed by the Applicant with the State of Florida's Division of Corporations or other State agencies. If none, indicate "None" See attached

Section E

1. Has the Applicant acquired another business entity within the last five (5) years?
Yes ___ No X If "Yes," please provide the full legal name of any business entity which the Applicant acquired during the last five (5) years which engaged in a similar business activity as the business activity which is the subject of this Port Everglades Franchise Application.
If none, indicate "None" None.

2. Indicate in the space provided the date of the acquisition and whether the acquisition was by a stock purchase or asset purchase and whether the Applicant herein is relying on the background and history of the acquired firm's officers, managers, employees and/or the acquired firm's business reputation in the industry to describe the Applicant's experience or previous business history. Attach additional sheets if necessary. N/A

3. Has the Applicant been acquired by another business entity within the last five (5) years?
Yes ___ No X If "Yes," provide the full legal name of any business entity which acquired the Applicant during the last five (5) years which engaged in a similar business activity as the business activity which is the subject of this Port Everglades Franchise Application.
If none, indicate "None" None.

4. Indicate in the space provided the date of the acquisition and whether the acquisition was by a stock purchase or asset purchase and whether the Applicant herein is relying on the background and history of the parent firm's officers, managers, employees and/or the parent firm's business reputation in the industry to describe the Applicant's experience or previous business history. Attach additional sheets if necessary. N/A

Section F

Provide the Applicant's previous business history, including length of time in the same or similar business activities as planned at Port Everglades. See attached

Section G

1. Provide a list of the Applicant's current managerial employees, including supervisors, superintendents, and forepersons. See attached

2. List the previous work history/experience of the Applicant's current managerial employees, including their active involvement in seaports and length of time in the same or similar business activities as planned at Port Everglades.

Section H

List all seaports, including Port Everglades (if application is for renewal), where the Applicant is currently performing the services/operation which is the subject of this Franchise application. **Use this form for each seaport listed. Photocopy additional pages as needed (one page for each seaport listed).**

If none, state "None" _____.

Seaport Jacksonville Number of Years Operating at this Seaport 38

List below all of the Applicant's Clients for which it provides services at the seaport listed above.

Client Name (Company)	Number of Years Applicant has Provided Services to this Client
Continental Florida Materials Inc.	38
A wholly owned subsidiary of Lehigh Cement Company	

Section H

List all seaports, including Port Everglades (if application is for renewal), where the Applicant is currently performing the services/operation which is the subject of this Franchise application. Use this form for each seaport listed. Photocopy additional pages as needed (one page for each seaport listed).

If none, state "None" _____.

Seaport Port Everglades Number of Years Operating at this Seaport 38

List below all of the Applicant's Clients for which it provides services at the seaport listed above.

Client Name (Company)	Number of Years Applicant has Provided Services to this Client
Continental Florida Materials Inc.	38
A wholly owned subsidiary of Lehigh Cement Company	

Section H

List all seaports, including Port Everglades (if application is for renewal), where the Applicant is currently performing the services/operation which is the subject of this Franchise application. **Use this form for each seaport listed. Photocopy additional pages as needed (one page for each seaport listed).**

If none, state "None" _____.

Seaport Port Canaveral Number of Years Operating at this Seaport 38

List below all of the Applicant's Clients for which it provides services at the seaport listed above.

Client Name (Company)	Number of Years Applicant has Provided Services to this Client
Continental Florida Materials Inc.	38
A wholly owned subsidiary of Lehigh Cement Company	

Section I

1. Provide a description of all past (within the last five (5) years) and pending litigation and legal claims where the Applicant is a named party, whether in the State of Florida or in another jurisdiction, involving allegations that Applicant has violated or otherwise failed to comply with environmental laws, rules, or regulations or committed a public entity crime as defined by Chapter 287, Florida Statutes, or theft-related crime such as fraud, bribery, smuggling, embezzlement or misappropriation of funds or acts of moral turpitude, meaning conduct or acts that tend to degrade persons in society or ridicule public morals.

The description must include all of the following:

- a) The case title and docket number
- b) The name and location of the court before which it is pending or was heard
- c) The identification of all parties to the litigation
- d) General nature of all claims being made

If none, indicate "None" None.

2. Indicate whether in the last five (5) years the Applicant or an officer, director, executive, partner, or a shareholder, employee or agent who is or was (during the time period in which the illegal conduct or activity took place) active in the management of the Applicant was charged, indicted, found guilty or convicted of illegal conduct or activity (with or without an adjudication of guilt) as a result of a jury verdict, nonjury trial, entry of a plea of guilty or nolo contendere where the illegal conduct or activity (1) is considered to be a public entity crime as defined by Chapter 287, Florida Statutes, as amended from time to time, or (2) is customarily considered to be a white-collar crime or theft-related crime such as fraud, smuggling, bribery, embezzlement, or misappropriation of funds, etc. or (3) results in a felony conviction where the crime is directly related to the business activities for which the franchise is sought.

Yes No

If you responded "Yes," please provide all of the following information for each indictment, charge, or conviction:

- a) A description of the case style and docket number
- b) The nature of the charge or indictment
- c) Date of the charge or indictment
- d) Location of the court before which the proceeding is pending or was heard
- e) The disposition (e.g., convicted, acquitted, dismissed, etc.)
- f) Any sentence imposed
- g) Any evidence which the County (in its discretion) may determine that the Applicant and/or person found guilty or convicted of illegal conduct or activity has conducted itself, himself or herself in a manner as to warrant the granting or renewal of the franchise.

Section J

The Applicant must provide a current certificate(s) of insurance. Franchise insurance requirements are determined by Broward County's Risk Management Division and are contained in the Port Everglades Tariff No. 12 as amended, revised or reissued from time to time. The Port Everglades Tariff is contained in the Broward County Administrative Code, Chapter 42, and is available for inspection on line at: <http://www.porteverglades.net/development/tariff>. See attached

Section K

1. The Applicant must provide its most recent audited or reviewed financial statements prepared in accordance with generally accepted accounting principles, or other documents and information which demonstrate the Applicant's creditworthiness, financial responsibility, and resources, which the Port will consider in evaluating the Applicant's financial responsibility. See attached

2. Has the Applicant or entity acquired by Applicant (discussed in Section E herein) sought relief under any provision of the Federal Bankruptcy Code or under any state insolvency law filed by or against it within the last five (5) year period?

Yes ___ No X

If "Yes," please provide the following information for each bankruptcy or insolvency proceeding:

- a) Date petition was filed or relief sought
- b) Title of case and docket number
- c) Name and address of court or agency
- d) Nature of judgment or relief
- e) Date entered

3. Has any receiver, fiscal agent, trustee, reorganization trustee, or similar officer been appointed in the last five (5) year period by a court for the business or property of the Applicant?

Yes ___ No X

If "Yes," please provide the following information for each appointment:

- a) Name of person appointed
- b) Date appointed
- c) Name and address of court
- d) Reason for appointment

4. Has any receiver, fiscal agent, trustee, reorganization trustee, or similar officer been appointed in the last five (5) year period by a court for any entity, business, or property acquired by the Applicant?

Yes ___ No X

If "Yes," please provide the following information for each appointment:

- a) Name of person appointed
- b) Date appointed
- c) Name and address of court
- d) Reason for appointment

Section L

List four (4) credit references for the Applicant, one of which must be a bank. Use this format:

Name of Reference _____ Nature of Business _____

Contact Name _____ Title _____

Legal Business Street Address _____

City, State, Zip Code _____

Phone Number (____) _____

See attached

(Provide on a separate sheet.)

Section M

1. Security: Pursuant to Port Everglades Tariff 12, Item 960, all Franchisees are required to furnish an Indemnity and Payment Bond or Irrevocable Letter of Credit drawn on a U.S. bank in a format and an amount not less than \$20,000 as required by Broward County Port Everglades Department. See attached
2. Has the Applicant been denied a bond or letter of credit within the past five (5) years?
Yes___ No x
If "Yes," please provide a summary explanation in the space provided of why the Applicant was denied. Use additional sheets if necessary.

Section N

1. Provide a list and description of all equipment currently owned and/or leased by the Applicant and intended to be used by the Applicant for the type of service(s) intended to be performed at Port Everglades including the age, type of equipment and model number. See attached
2. Identify the type of fuel used for each piece of equipment.
3. Indicate which equipment, if any, is to be domiciled at Port Everglades.
4. Will all equipment operators be employees of the Applicant, on the payroll of the Applicant, with wages, taxes, benefits, and insurance paid by the Applicant?
Yes x No___
If "No," please explain in the space provided who will operate the equipment and pay wages, taxes, benefits, and insurance, if the franchise is granted. Use additional sheets if necessary.

Section O

Provide a copy of the Applicant's current Broward County Business Tax Receipt (formerly Occupational License). See attached

Section P

1. Provide a copy of Applicant's safety program.
2. Provide a copy of Applicant's substance abuse policy.
3. Provide a copy of Applicant's employee job training program/policy.
4. Provide information regarding frequency of training.
5. Include equipment operator certificates, if any.

Section Q

1. Has the Applicant received within the past five (5) years or does the Applicant have pending any citations, notices of violations, warning notices, or fines from any federal, state, or local environmental regulatory agencies?
Yes No

2. Has the Applicant received within the past five (5) years or does the Applicant have pending any citations, notices of violations, warning notices, or civil penalties from the U.S. Coast Guard?
Yes No

3. Has the Applicant received within the past five (5) years or does the Applicant have pending any citations, notices of violations, warning notices, or fines from the Occupational Safety and Health Administration?
Yes No

If you responded "Yes" to any of this section's questions 1, 2, or 3 above, please provide a detailed summary for each question containing the following information: See attached

- a) Name and address of the agency issuing the citation or notice
- b) Date of the notice
- c) Nature of the violation
- d) Copies of the infraction notice(s) from the agency
- e) Disposition of case
- f) Amount of fines, if any
- g) Corrective action taken

Attach copies of all citations, notices of violations, warning notices, civil penalties and fines issued by local, state, and federal regulatory agencies, all related correspondence, and proof of payment of fines.

4. Provide a statement (and/or documentation) which describes the Applicant's commitment to environmental protection, environmental maintenance, and environmental enhancement in the Port.

Section R

Provide written evidence of Applicant's ability to promote and develop growth in the business activities, projects or facilities of Port Everglades through its provision of the services (i.e., stevedore, cargo handler or steamship agent) it seeks to perform at Port Everglades. For first-time applicants (stevedore, cargo handler and steamship agent), the written evidence must demonstrate Applicant's ability to attract and retain new business such that, Broward County may determine in its discretion that the franchise is in the best interests of the operation and promotion of the port and harbor facilities. The term "new business" is defined in Chapter 32, Part II of the Broward County Administrative Code as may be amended from time to time. See attached

If you have checked an Applicant box for VESSEL BUNKERING, VESSEL OILY WASTE REMOVAL, VESSEL SANITARY WASTE WATER REMOVAL, OR MARINE TERMINAL SECURITY, the following additional information is required:

VESSEL BUNKERING

Section T- A Letter of Adequacy from the U.S. Coast Guard and a copy of the applicant's operations manual approved by the U.S. Coast Guard.

Section V- A copy of the applicant's Oil Spill Contingency Plan for Marine Transportation Related Facilities approved by the U.S. Coast Guard.

Section W- A Terminal Facility Discharge Prevention and Response Certificate with a copy of an approved Oil Spill Contingency Plan from the Florida Dept. of Environmental Protection.

Section Z- An approved Discharge Cleanup Organization Certificate from the Florida Dept. of Environmental Protection which has been issued to the applicant or to its cleanup contractor with a copy of the cleanup contract showing the expiration date.

VESSEL OILY WASTE REMOVAL

Section S - Certificate of Adequacy in compliance with the Directives of MARPOL 73/75 and 33 CFR 158, if applicable.

Section T- A Letter of Adequacy from the U.S. Coast Guard and a copy of the Applicant's operations manual approved by the U.S. Coast Guard.

Section U- A Waste Transporter License from the Broward County Environmental Protection Department identifying the nature of the discarded hazardous (or non-hazardous) material to be transported.

Section V- A copy of the Applicant's Oil Spill Contingency Plan for Marine Transportation Related Facilities approved by the U.S. Coast Guard.

Section W- A Terminal Facility Discharge Prevention and Response Certificate with a copy of an approved Oil Spill Contingency Plan from the Florida Dept. of Environmental Protection.

Section X- A Used Oil Collector, Transporter, and Recycler Certificate from the Florida Dept. of Environmental Protection.

Section Y- An Identification Certificate from the U.S. Environmental Protection Agency.

Section Z- An approved Discharge Cleanup Organization Certificate from the Florida Dept. of Environmental Protection which has been issued to the Applicant or to its cleanup contractor with a copy of the cleanup contract showing the expiration date.

VESSEL SANITARY WASTE WATER REMOVAL

Section U- A Waste Transporter License from the Broward County Environmental Protection Department identifying the nature of the discarded hazardous (or non-hazardous) material to be transported.

Section Z1- A copy of the Applicant's operations manual.

Section Z2- A Septage Receiving Facility Waste Hauler Discharge Permit from the Broward County Water and Wastewater Services Operations Division.

MARINE TERMINAL SECURITY

Section N1- A list of all metal detection devices, walk-through and hand held, as well as all luggage and carryon x-ray machines owned or leased, to be used or domiciled at Port Everglades. Listing must include brand name and model.

Section N2- A copy of all manufacturers recommended service intervals and name of

company contracted to provide such services on all aforementioned equipment.

Section N3- A description of current method employed to assure all equipment is properly calibrated and functioning.

Section N4- current training requirements and training syllabus for employees operating x-ray equipment. Highlight emphasis on weapon and contraband identification.

Include equipment operator certificates, if any.

Section O1- Provide copies of all local, state and federal licenses, including:

- a. A copy of the Applicant's State of Florida Business License.
- b. A copy of security agency's Manager's "M" or "MB" License and a copy of the security agency's "B" or "BB" License issued by the Florida Department of Agriculture and Consumer Services.

Section P3- SECURITY GUARDS / SUPERVISORS

- a. Provide Applicant's background requirements, education, training etc., for personnel hired as security guards.
- b. Provide historic annual turnover ratio for security guards.
- c. Provide a copy of Applicant's job training program/policy including a copy of training curriculum and copies of all manuals and take-home materials made available to security guards. Include information regarding frequency of training.
- d. Provide background requirements, experience, licensing and any and all advanced training provided to supervisory personnel.
- e. Provide present policy for individual communication devices either required of security guards or supplied by the employer.
- f. Provide procurement criteria and source as well as Applicant's certification requirements for K-9 workforce.
- g. Provide information on the number of security guards / supervisors currently employed or expected to be employed to provide security services at Port Everglades.

Supervisors _____
Class D Guards _____
Class G Guards _____
K-9 Handlers _____

Port Everglades Tariff 12

References to the Port Everglades Tariff 12 as amended or reissued: <http://www.porteverglades.net/development/tariff>

Application Fees

The following fees have been established for franchised businesses at Port Everglades. Initial processing fees are nonrefundable. A franchise is required for each category of business.

Stevedore

Initial processing fee, assignment fee, or reinstatement fee \$ 11,000.00

Annual Fee

\$ 4,000.00

Cargo Handler

Initial processing fee, assignment fee, or reinstatement fee \$ 11,000.00

Annual Fee

\$ 4,000.00

Steamship Agent

Initial processing fee, assignment fee, or reinstatement fee \$

4,000.00

Annual Fee

\$ 2,250.00

Tugboat and Towing

Initial processing fee, assignment fee, or reinstatement fee \$ 26,000.00

Annual Fee

By Contract

Vessel Bunkering, Vessel Oily Waste Removal,

Vessel Sanitary Waste Water Removal

Initial processing fee, assignment fee, or reinstatement fee \$ 4,000.00

Annual Fee

\$ 2,250.00

For first-time franchise Applicants, both the initial application fee and the annual fee must be submitted at time of application. Thereafter, annual franchise fees are due and payable each year on the franchise anniversary date, which is defined as the effective date of the franchise.

Note: Check(s) should be made payable to:

BROWARD COUNTY BOARD OF COUNTY COMMISSIONERS and be mailed with this application to:

Port Everglades Business Administration Division

1850 Eller Drive, Fort Lauderdale, FL 33316

Required Public Hearing

Staff review of this application will not commence until such time as all of the above requested information and documentation has been provided and the franchise application has been determined by staff to be complete. All of the above requested information and Sections are required to be completed prior to the scheduling of the public hearing. Staff will request that the Broward County Board of County Commissioners set a public hearing to consider the franchise application and hear comments from the public. The Applicant will be notified of the Public Hearing date and must plan to attend the Public Hearing.

By signing and submitting this application, Applicant certifies that all information provided in this application is true and correct. Applicant understands that providing false or misleading information on this application may result in the franchise application being denied, or in instances of renewal, a franchise revoked. Applicant hereby waives any and all claims for any damages resulting to the Applicant from any disclosure or publication in any manner of any material or information acquired by Broward County during the franchise application process or during any inquiries, investigations, or public hearings.

Applicant further understands that if there are any changes to the information provided herein (subsequent to this application submission) or to its officers, directors, senior management personnel, or business operation as stated in this application, Applicant agrees to provide such updated information to the Port Everglades Department of Broward County, including the furnishing of the names, addresses (and other information as required above) with respect to persons becoming associated with Applicant after its franchise application is submitted, and any other required documentation requested by Port Everglades Department staff as relating to the changes in the business operation. This information must be submitted within ten (10) calendar days from the date of any change made by the Applicant.

Applicant certifies that all workers performing functions for Applicant who are subject to the Longshore and Harbor Workers' Act are covered by Longshore & Harbor Workers' Act, Jones Act Insurance, as required by federal law.

This application and all related records are subject to Chapter 119, F.S., the Florida Public Records Act.

By its execution of this application, Applicant acknowledges that it has read and understands the rules, regulations, terms and conditions of the franchise it is applying for as set forth in Chapter 32, Part II, of the Broward County Administrative Code as amended, and agrees, should the franchise be granted by Broward County, to be legally bound and governed by all such rules, regulations, terms and conditions of the franchise as set forth in Chapter 32, Part II, of the Broward County Administrative Code as amended.

The individual executing this application on behalf of the Applicant, personally warrants that s/he has the full legal authority to execute this application and legally bind the Applicant.

Signature of Applicant's Authorized Representative  Date Signed 2/14/19

Signature name and title - typed or printed Phil Detwiler, Vice President and General Manager

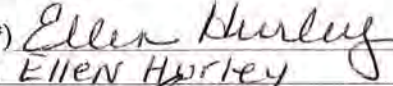
Witness Signature (*Required*) 
Witness name-typed or printed ELLEN HURLEY

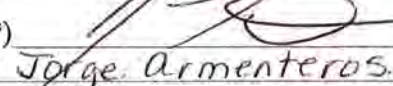
Witness Signature (*Required*) 
Witness name-typed or printed Jorge Armenteros

If a franchise is granted, all official notices/correspondence should be sent to:

Name Carlos Gonzalez Title Terminal Manager

Address 2600 Eisenhower Boulevard Phone (954) 523-8442
Port Everglades, FL 33316

Section A.2

Lehigh Hanson
HEIDELBERGCEMENTGroup

Glenn Heller

***President, South Region
Lehigh Hanson, Inc.***



Glenn Heller is President of Lehigh Hanson's South Region. Lehigh Hanson, Inc. is a wholly-owned subsidiary of HeidelbergCement, the global market leader in aggregates and a prominent player in the fields of cement, concrete, and other downstream activities.

Heller joined the company in 1997 and has extensive experience in the construction materials industry. Over the years, Heller held a variety of senior management roles within the organization and prior to his most recent position as Vice President of Finance for the South Region, he served as Vice President, Financial Planning & Analysis.

Heller holds a Bachelor of Science in Accounting from Rider University.

Lehigh Hanson
HEIDELBERGCEMENTGroup

Henner Böttcher

***Senior Vice President and Chief Financial Officer
Lehigh Hanson, Inc.***



Henner Böttcher is Senior Vice President and Chief Financial Officer for Lehigh Hanson, Inc., a wholly-owned subsidiary of HeidelbergCement, the global market leader in aggregates and a prominent player in the fields of cement, concrete, and other downstream activities.

Böttcher joined HeidelbergCement in 2003 and has held a variety of management positions within the company's Treasury and Finance departments. He previously served as Group Treasurer for HeidelbergCement, a position he held since 2006.

Before joining HeidelbergCement, Böttcher spent seven years at Deutsche Bank. He graduated in Business Administration at the Frankfurt School of Finance & Management in Germany and is a Chartered Financial Analyst (CFA) charter holder.

Lehigh Hanson
HEIDELBERGCEMENT Group

Carol Lowry

***Vice President and General Counsel
Lehigh Hanson, Inc.***



Carol Lowry is Vice President & General Counsel for Lehigh Hanson, Inc., a wholly-owned subsidiary of HeidelbergCement, the global market leader in aggregates and a prominent player in the fields of cement, concrete, and other downstream activities.

Prior to joining the company, Lowry held the position of Vice President & General Counsel for Essroc. Previously she was Associate General Counsel at Carpenter Technology Corporation and also held attorney positions at FirstEnergy and Brouse McDowell.

Lowry earned her J.D. degree from Case Western Reserve University School of Law in Cleveland and has a B.A. from Carlow University in Pittsburgh.



Phil Detwiler

***Vice President, Cement Sales Southeast
Lehigh Hanson, Inc.***

Phil Detwiler is Vice President, Cement Sales Southeast, for Lehigh Hanson's South Region. Lehigh Hanson, Inc. is a wholly-owned subsidiary of HeidelbergCement, the global market leader in aggregates and a prominent player in the fields of cement, concrete, and other downstream activities.

Detwiler has been with the company since 1986 and has held a variety of senior management positions over the years.

Section B.2

CERTIFICATE OF ASSISTANT SECRETARY
OF
CONTINENTAL FLORIDA MATERIALS INC.

I, AMY C. YI, do hereby certify that I am the duly elected, qualified and acting Assistant Secretary of CONTINENTAL FLORIDA MATERIALS INC., a Florida corporation (the "Company"), and, as such, am familiar with the corporate records of the Company. I am authorized to certify on behalf of the Company that:

- (1) Attached to this Certificate as EXHIBIT A is a true and correct copy of the Certificate of Incorporation filed on December 13, 1974, with the Secretary of State of Florida, incorporating Sunshine Paper, Inc., a Florida corporation.
- (2) Attached to this Certificate as EXHIBIT B is a true and correct copy of the Certificate of Amendment to Articles of Incorporation filed on September 22, 1975, with the Secretary of State of Florida, changing the name of Sunshine Papers, Inc., a Florida corporation, to Sunshine Ready Mix Concrete Company, Inc., a Florida corporation.
- (3) Attached to this Certificate as EXHIBIT C is a true and correct copy of the Articles of Amendment, filed on December 13, 1990, with the Secretary of State of Florida, changing the name of Sunshine Ready Mix Concrete Company, Inc., a Florida corporation, to Thomas Concrete of Florida, Inc., a Florida corporation.
- (4) Attached to this Certificate as EXHIBIT D is a true and correct copy of the Articles of Amendment, filed on June 12, 1996, with the Secretary of State of Florida, changing the name of Thomas Concrete of Florida, Inc., a Florida corporation, to Continental Concrete Inc., a Florida corporation.
- (5) Attached to this Certificate as EXHIBIT E is a true and correct copy of the Articles of Merger, filed on June 23, 1999, with the Secretary of State of Florida, merging Continental Florida Materials, Inc., a Florida corporation into Continental Concrete Inc. and changed its name to Continental Florida Materials Inc., a Florida corporation.

IN WITNESS WHEREOF, the undersigned has hereunto subscribed her name and affixed hereto the official seal of the Company on this 14th day of February, 2019.



[CORPORATE SEAL]



Amy C. Yi
Assistant Secretary



STATE OF FLORIDA

DEPARTMENT OF STATE



I, DOROTHY W. GLISSON, Secretary of State of the State of Florida, do hereby
certify that the following is a true and correct copy of

CERTIFICATE OF INCORPORATION

OF

SUNSHINE PAPER, INC.

a corporation organized and existing under the Laws of the State of Florida, filed on
the 13th day of December, A.D., 1974 as shown by the records of
this office. **EFFECTIVE DATE 12-9-74**



GIVEN under my hand and the Great
Seal of the State of Florida, at
Tallahassee, the Capital, this the
17th day of December,
A.D., 1974.

Dorothy W. Glisson

SECRETARY OF STATE

ARTICLES OF INCORPORATION
OF
SUNSHINE PAPER, INC.

The undersigned subscriber to these Articles of Incorporation, a natural person competent to contract, hereby organizes and incorporates a corporation under the laws of the State of Florida.

ARTICLE I. NAME

The name of the corporation is SUNSHINE PAPER, INC.

ARTICLE II. NATURE OF BUSINESS

The corporation may engage in any activity or business permitted under the laws of the United States or of this state.

ARTICLE III. CAPITAL STOCK

The maximum number of shares of stock that this corporation is authorized to have outstanding at any one time is 5,000 shares of common stock having a nominal or par value of \$1.00 per share.

ARTICLE IV. INITIAL CAPITAL

The amount of capital with which this corporation will begin business is more than FIVE HUNDRED DOLLARS (\$500.00).

ARTICLE V. BEGINNING OF CORPORATE EXISTENCE

The date when the corporate existence of this corporation shall begin business shall be December 9, 1974, the time of subscription and acknowledgment of these Articles of Incorporation.

ARTICLE VI. TERM OF EXISTENCE

This corporation is to exist perpetually.

ARTICLE VII. ADDRESS

The initial post office address of the principal office of this corporation in the State of Florida is 1475 East 11th Avenue, Hialeah, Florida 33010. The Board of Directors may from

FILED
DEC 12 2 21 PM '74
CLERK OF STATE
TALLAHASSEE, FLORIDA

time to time move the principal office to any other address.

ARTICLE VIII. DIRECTORS

This corporation shall have three (3) directors initially. The number of directors may be increased or diminished from time to time by By-Laws adopted by the stockholders, but there shall always be at least three (3) directors.

To the extent permitted by law, the corporation shall indemnify and hold harmless each person serving as a director or officer of the corporation, and each person who serves at the request of the corporation as a director or officer of any other corporation, from and against any and all claims and liabilities to which such person shall become subject by reason of his being a director or officer of the corporation, or by reason of any action alleged to have been taken or omitted by him as a director or officer. The corporation shall reimburse each such person for all costs, legal and other expenses reasonably incurred by him in connection with any claim or liability as to which it shall be adjudged that such officer or director is liable to the extent permitted by law.

The rights accruing to any person under the foregoing provisions shall not exclude any other right to which he may be lawfully entitled, nor shall anything herein contained restrict the right of the corporation to indemnify or reimburse such person in any proper case even though not specifically provided for herein.

No contract or other transaction between this corporation and any other firm or corporation, and no act of this corporation shall in any way be affected or invalidated by the fact that any of the directors of the corporation are pecuniarily or otherwise interested in, or are directors or officers of, such other firm or corporation, provided that the fact that he is so interested shall be disclosed or shall have been known to the Board of Directors or such members thereof as shall be present at any meeting of the board at which action upon any such contract or transaction shall be taken; and any director of the corporation

who is also a director or officer of such other corporation, or is so interested, may be counted in determining the existence of a quorum at any meeting of the Board of Directors of the corporation which shall authorize any such contract or transaction, and may vote thereat to authorize any such contract or transaction, with the like force and effect as if he were not a director or officer of such other corporation or not to interested.

ARTICLE IX. INITIAL OFFICERS AND DIRECTORS

The names and post office addresses of the members of the first Board of Directors are:

JUAN VILASECA	1475 East 11th Avenue Hialeah, Florida 33010
VICENTE F. CRUZ	1475 East 11th Avenue Hialeah, Florida 33010
JOSE W. RODRIGUEZ	1475 East 11th Avenue Hialeah, Florida 33010

The initial officers of this corporation are:

President:	JUAN VILASECA
Vice President:	VICENTE F. CRUZ
Secretary	JOSE W. RODRIGUEZ

ARTICLE X. SUBSCRIBER

The name and post office address of the subscriber to these Articles of Incorporation is:

WILLIAM L. NORIEGA	2100 First Federal Building One S.E. Third Avenue Miami, Florida 33131
--------------------	--

ARTICLE XI. AMENDMENTS

These Articles of Incorporation may be amended in the manner provided by law. Every amendment shall be approved by the Board of Directors, proposed by it to the stockholders, and approved at the stockholders' meeting by a majority of the stock entitled to vote thereon, unless all the directors and all the stockholders sign a written statement manifesting their intention that a certain amendment of these Articles of Incorporation be made.

IN WITNESS WHEREOF, the undersigned has hereunto set his hand and seal and has acknowledged and filed in the office of the Secretary of State of Florida as subscriber of SUNSHINE PAPER, INC., the foregoing Articles of Incorporation this 9th day of December, 1974.

WILLIAM L. NORIEGA

STATE OF FLORIDA)
) ss:
COUNTY OF DADE)

I HEREBY CERTIFY that on this day before me, a Notary Public duly authorized in the State and County named above to take acknowledgments, personally appeared WILLIAM L. NORIEGA, to me known and known to me to be the person described as Subscriber in, and who executed the foregoing Articles of Incorporation, and he acknowledged before me that he subscribed to those Articles of Incorporation.

WITNESS my hand and official seal at Miami, Dade County, Florida, this 9th day of December, 1974.

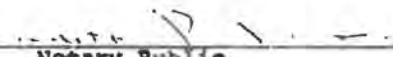
Notary Public
State of Florida at Large

My Commission expires:

STATE OF FLORIDA
DEPARTMENT OF STATE 

I, BRUCE A. SMATHERS, Secretary of State of the State of Florida, do hereby certify that the following is a true and correct copy of Certificate of Amendment to Articles of Incorporation of SUNSHINE PAPER, INC., a corporation organized and existing under the laws of the State of Florida, amending its corporate name to SUNSHINE READY MIX CONCRETE COMPANY, INC., filed on the 22nd day of September, A. D., 1975, as shown by the records of this office.



GIVEN under my hand and the Great Seal of the State of Florida, at Tallahassee, the Capital, this the 26th day of September A.D., 1975

Bruce A. Smathers
SECRETARY OF STATE

CERTIFICATE OF AMENDMENT
OF
ARTICLES OF INCORPORATION

SUNSHINE PAPER, INC., a Florida corporation, under its corporate seal and the hand of its President, GENE VENINGA, and its Secretary, JAMES P. BLIND, hereby certifies that:

The Stockholders and Board of Directors of said Corporation, at a meeting called and held on July 17, 1975, adopted the following resolution:

RESOLVED, that ARTICLE I of the Articles of Incorporation of the Corporation be, and the same is, hereby amended to read as follows:

"ARTICLE I. NAME

"The name of the Corporation is SUNSHINE READY MIX CONCRETE COMPANY, INC."

IN WITNESS WHEREOF, said Corporation has caused this Certificate to be signed in its name by its President and its corporate seal to be hereunto affixed and attested by its Secretary this 22nd day of August, 1975.

SUNSHINE PAPER, INC.

By: Gene Veninga
GENE VENINGA, President

(Corporate Seal)

Attest: James P. Blind
JAMES P. BLIND
Secretary

STATE OF FLORIDA)
 : SS
COUNTY OF DADE)

ON THIS DAY personally appeared before me, the undersigned authority duly authorized by the laws of the state of Florida

FILED
SEP 22 11 15 AM 1975
SECRETARY OF STATE
MIAMI FLORIDA

to take acknowledgments of deeds, GENE VENINGA, President of SUNSHINE PAPER, INC., a Florida corporation, and he acknowledged before me that he executed the above and foregoing Certificate of Amendment as such officer, for and on behalf of said Corporation, after having been duly authorized to so do.

WITNESS my hand and official seal at Miami, Dade County, Florida, this 22 day of August, 1975.

Det H Jobs
NOTARY PUBLIC, State of Florida at Large

My commission expires:

NOTARY PUBLIC STATE OF FLORIDA AT LARGE
MY COMMISSION EXPIRES OCT. 12, 1976
BONDED THRU GENERAL INSURANCE UNDERWRITERS

FILED
SEP 22 11 15 AM 1975
SECRETARY OF STATE
MIAMI FLORIDA

EXHIBIT

C

State of Florida



Department of State

I certify that the attached is a true and correct copy of the Articles of Amendment, filed on December 13, 1990, to Articles of Incorporation for SUNSHINE READY MIX CONCRETE COMPANY, INC., changing its name to THOMAS CONCRETE OF FLORIDA, INC., a Florida corporation, as shown by the records of this office.

The document number of this corporation is 466221.

Given under my hand and the
Great Seal of the State of Florida,
at Tallahassee, the Capital, this the
21st day of December, 1990.



CR2EO22 (6-88)

Jim Smith
Secretary of State

FILED

1992 DEC 22 PM 2:53

SECRETARY OF STATE
TALLAHASSEE, FLORIDA

ARTICLES OF AMENDMENT
TO THE
ARTICLES OF INCORPORATION
OF
THOMAS CONCRETE OF FLORIDA, INC.

Pursuant to the provisions of §§ 607.1003 and 607.1006 of the Florida Business Corporation Act, the undersigned corporation adopts the following amendment to its Articles of Incorporation:

1. The name of the corporation is Thomas Concrete of Florida, Inc. (the "Corporation").
2. The following amendment to the Corporation's Articles of Incorporation has been duly adopted by the Board of Directors and the Shareholders of the Corporation:

"Article III of the Articles of Incorporation of the Corporation be amended by deleting said Article in its entirety and by substituting in lieu thereof the following:

'ARTICLE' III. CAPITAL STOCK

The corporation is authorized to issue two classes of shares of stock: common stock and Class A preferred stock.

The total number of shares of common stock which the corporation shall have authority to issue is ten thousand (10,000) shares of common stock of One Dollar (\$1.00) par value. The total number of shares of Class A preferred stock (the "Preferred Stock") which the corporation shall have authority to issue is two hundred (200) shares of Preferred Stock of One Dollar (\$1.00) par value.

The Preferred Stock shall have certain limitations and rights and preferences superior to the common stock as outlined in paragraphs (1) and (2) below:

-1-

(1) Voting Rights; Distributions.

Except as otherwise required by the Florida Business Corporation Act, holders of the Preferred Stock shall have no voting rights and powers, and their consent shall not be required for taking any corporate action. Holders of the Preferred Stock shall not be entitled to distributions of any type except as provided in paragraph (2) below.

(2) Rights on Dissolution.

On any dissolution, liquidation or winding up of the corporation, whether voluntary or involuntary, before any distribution of cash or other assets is made to the holders of common stock, the holders of the Preferred Stock shall be paid an amount equal to Ten Thousand Dollars (\$10,000.00) per share. After these amounts have been paid or distributed to the holders of the Preferred Stock, the remaining assets and funds of the corporation shall be divided and distributed ratably among the holders of common stock.'"

3. The above amendment was adopted by the written consent of the sole Shareholder of the Corporation on December 22, 1992 in the manner prescribed by the Florida Business Corporation Act.

THOMAS CONCRETE OF FLORIDA,
INC.

By: 
Name: Jan Meijer
Title: President



FLORIDA DEPARTMENT OF STATE
Sandra B. Mortham
Secretary of State

June 13, 1996

CSC NETWORKS
VICTORIA
TALLAHASSEE, FL

Re: Document Number 466221

The Articles of Amendment to the Articles of Incorporation for THOMAS CONCRETE OF FLORIDA, INC. which changed its name to CONTINENTAL CONCRETE INC., a Florida corporation, were filed on June 12, 1996.

The certification requested is enclosed.

Should you have any question regarding this matter, please telephone (904) 487-6050, the Amendment Filing Section.

Joy Moon-French
Corporate Specialist
Division of Corporations

Letter Number: 696A00029477

Account number: 072100000032

Account charged: 87.50

State of Florida



Department of State

I certify the attached is a true and correct copy of the Articles of Amendment, filed on June 12, 1996, to Articles of Incorporation for THOMAS CONCRETE OF FLORIDA, INC. which changed its name to CONTINENTAL CONCRETE INC., a Florida corporation, as shown by the records of this office.

The document number of this corporation is 466221.

Given under my hand and the
Great Seal of the State of Florida,
at Tallahassee, the Capitol, this the
Thirteenth day of June, 1996



CR2EO22 (2-95)

A handwritten signature in cursive script, reading "Sandra B. Northam".

Sandra B. Northam
Secretary of State

ARTICLES OF AMENDMENT
OF
THOMAS CONCRETE OF FLORIDA, INC.

FILED
96 JUN 12 PM 4:28
SECRETARY OF STATE
TALLAHASSEE FLORIDA

To the Department of State
State of Florida

Pursuant to the provisions of Section 607.1006 of the Florida Business Corporation Act, the corporation hereinafter named (the "corporation") does hereby adopt the following Articles of Amendment.

1. The name of the corporation is Thomas Concrete of Florida, Inc.
2. Article I of the Articles of Incorporation of the corporation is hereby amended so as henceforth to read as follows:

The name of the corporation is "CONTINENTAL
CONCRETE INC."

3. The date of adoption of the aforesaid amendment was May 29, 1996.
4. The number of votes cast for the said amendment by the shareholders was sufficient for the approval thereof.
5. This amendment to the Articles of Incorporation of the corporation shall take affect immediately.

Executed on June 3, 1996.

THOMAS CONCRETE OF FLORIDA, INC.

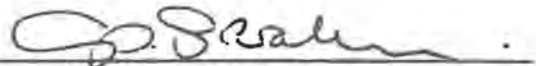

Name of Officer: Gosta Swahn
Title of Officer: President



ARTICLES OF MERGER
Merger Sheet

MERGING:

CONTINENTAL FLORIDA MATERIALS, INC., a Florida corporation,
P99000050651

INTO

CONTINENTAL CONCRETE INC. which changed its name to
CONTINENTAL FLORIDA MATERIALS INC., a Florida corporation, 466221

File date: June 23, 1999

Corporate Specialist: Cheryl Coulliette

**ARTICLES OF MERGER
OF
CONTINENTAL FLORIDA MATERIALS, INC.
AND
CONTINENTAL CONCRETE INC.**

FILED
99 JUN 23 PM 2:45
SECRETARY OF STATE
TALLAHASSEE, FLORIDA

To the Department of State
State of Florida

Pursuant to the provisions of the Florida Business Corporation Act, the Florida parent business corporation and the Florida wholly-owned subsidiary business corporation named below do hereby submit the following Articles of Merger.

1. Annexed hereto and made a part hereof is a Plan of Merger for merging Continental Florida Materials, Inc. into Continental Concrete Inc., as approved by the Board of Directors of the parent corporation on June 18, 1999.

2. The aforesaid Plan of Merger was adopted in accordance with the provisions of the Florida Business Corporation Act on June 18, 1999.

3. Effective June 24, 1999 the name of Continental Concrete Inc. shall be changed to Continental Florida Materials Inc.

4. The Shareholders of Continental Florida Materials, Inc. and Continental Concrete Inc. approved the merger and the change of the name of Continental Concrete Inc. to Continental Florida Materials Inc.

5. The effective time and date of the merger herein provided for shall be 9:00 a.m. June 24, 1999.

Executed on June 21, 1999.

Continental Florida Materials, Inc.

By: 
Name: Gosta Swahn
Capacity: President

Continental Concrete Inc.

By: 
Name: Gosta Swahn
Capacity: President

EXHIBIT A

PLAN OF MERGER

1. Continental Concrete Inc., which is a business corporation of the State of Florida and is the owner of all of the outstanding shares of Continental Florida Materials, Inc., which is also a business corporation of the State of Florida, hereby merges Continental Concrete Inc. into Continental Florida Materials, Inc. pursuant to the provisions of the Florida Business Corporation Act.
2. The separate existence of Continental Florida Materials, Inc. shall cease at the effective time and date of the merger, and Continental Concrete Inc. shall continue its existence as the surviving corporation pursuant to the provisions of the Florida Business Corporation Act.
3. The issued shares of Continental Florida Materials, Inc. shall not be converted in any manner, but each said share which is issued immediately prior to the effective time and date of the merger shall be surrendered and extinguished.
4. The name of Continental Concrete Inc. shall be changed to Continental Florida Materials Inc. upon the effective date of the merger.
5. The Board of Directors and the proper officers of Continental Concrete Inc. are hereby authorized, empowered, and directed to do any and all acts and things, and to make, execute, deliver, file, and/or record any and all instruments, papers, and documents which shall be or become necessary, proper, or convenient to carry out or put into effect any of the provisions of this Plan of Merger or of the merger herein provided for.

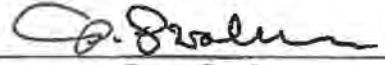

[Department of State](#) / [Division of Corporations](#) / [Search Records](#) / [Detail By Document Number](#) /

Detail by Entity Name

Florida Profit Corporation
CONTINENTAL FLORIDA MATERIALS INC.

Filing Information

Document Number	466221
FEI/EIN Number	59-1616110
Date Filed	12/13/1974
State	FL
Status	ACTIVE
Last Event	CORPORATE MERGER
Event Date Filed	12/26/2018
Event Effective Date	07/01/1999

Principal Address

2600 Eisenhower Boulevard
Port Everglades, FL 33316

Changed: 02/04/2013

Mailing Address

300 E. JOHN CARPENTER FREEWAY
Legal Dept
IRVING, TX 75062

Changed: 02/04/2013

Registered Agent Name & Address

CORPORATION SERVICE COMPANY
1201 HAYS STREET
TALLAHASSEE, FL 32301-2525

Name Changed: 08/21/2009

Address Changed: 08/21/2009

Officer/Director Detail

Name & Address

Title Director, Chairman

MORRISH, JONATHAN

300 E. JOHN CARPENTER FREEWAY
 IRVING, TX 75062

Title Asst. Secretary

YI, AMY
 300 E. JOHN CARPENTER FREEWAY
 IRVING, TX 75062

Title Vice President & CFO, Director

Boettcher, Henner
 300 E. JOHN CARPENTER FREEWAY
 IRVING, TX 75062

Title President, Director

HELLER, GLENN
 300 E JOHN CARPENTER FREEWAY
 IRVING, TX 75062

Title VP, Secretary

LOWRY, CAROL
 300 E. JOHN CARPENTER FREEWAY
 Legal Dept
 IRVING, TX 75062

Title Treasurer

ROBBINS, REBECCA
 300 E. JOHN CARPENTER FREEWAY
 IRVING, TX 75062

Title Asst. Secretary

HAAS, THADDIUS
 300 E. JOHN CARPENTER FREEWAY
 IRVING, TX 75062

Annual Reports

Report Year	Filed Date
2016	04/26/2016
2017	04/26/2017
2018	04/20/2018

Document Images

12/26/2018 -- Merger	View image in PDF format
04/20/2018 -- ANNUAL REPORT	View image in PDF format
04/26/2017 -- ANNUAL REPORT	View image in PDF format
04/26/2016 -- ANNUAL REPORT	View image in PDF format

04/27/2015 -- ANNUAL REPORT	View image in PDF format
05/20/2014 -- ANNUAL REPORT	View image in PDF format
02/04/2013 -- ANNUAL REPORT	View image in PDF format
05/01/2012 -- ANNUAL REPORT	View image in PDF format
04/26/2011 -- ANNUAL REPORT	View image in PDF format
04/09/2010 -- ANNUAL REPORT	View image in PDF format
08/21/2009 -- Reg. Agent Change	View image in PDF format
04/28/2009 -- ANNUAL REPORT	View image in PDF format
04/30/2008 -- ANNUAL REPORT	View image in PDF format
05/01/2007 -- ANNUAL REPORT	View image in PDF format
05/02/2006 -- ANNUAL REPORT	View image in PDF format
04/26/2005 -- ANNUAL REPORT	View image in PDF format
04/15/2004 -- ANNUAL REPORT	View image in PDF format
03/05/2003 -- ANNUAL REPORT	View image in PDF format
11/15/2002 -- ANNUAL REPORT	View image in PDF format
02/01/2002 -- ANNUAL REPORT	View image in PDF format
05/18/2001 -- ANNUAL REPORT	View image in PDF format
01/12/2001 -- Reg. Agent Change	View image in PDF format
03/28/2000 -- ANNUAL REPORT	View image in PDF format
06/29/1999 -- Merger	View image in PDF format
06/23/1999 -- Merger	View image in PDF format
05/27/1999 -- Merger	View image in PDF format
02/24/1999 -- ANNUAL REPORT	View image in PDF format
02/02/1998 -- ANNUAL REPORT	View image in PDF format
03/10/1997 -- REG. AGENT CHANGE	View image in PDF format
01/17/1997 -- ANNUAL REPORT	View image in PDF format
01/30/1996 -- ANNUAL REPORT	View image in PDF format
01/20/1995 -- ANNUAL REPORT	View image in PDF format
01/20/1995 -- ANNUAL REPORT	View image in PDF format

Jon Morrish

***President and Chief Executive Officer, Lehigh Hanson, Inc.
Member of the Managing Board, HeidelbergCement***



Jon Morrish is President and Chief Executive officer of Lehigh Hanson, Inc. He is also a Member of the Managing Board of HeidelbergCement with responsibility for the Group area North America.

Morrish has been with the company since 1999 and most recently served as the President of Lehigh Hanson's South Region, a position he held since September 1, 2012.

He also held the position of Managing Director of the Hanson cement business in the United Kingdom as well as Managing Director of Hanson Concrete.

Morrish earned a Master of Business Administration from Cranfield School of Management and a Bachelor of Science in Biochemistry from Leeds University.



Rebecca Robbins

***Treasury Manager
Lehigh Hanson, Inc.***

Rebecca Robbins is Treasury Manager for Lehigh Hanson, Inc., a wholly-owned subsidiary of HeidelbergCement, the global market leader in aggregates and a prominent player in the fields of cement, concrete, and other downstream activities.

Robbins originally joined the company in 2005 as a member of a special services team as the Treasury Accountant and she moved into the Treasury department before leaving the company in 2011. She was rehired in 2015 in her current position of Treasury Manager.



Thaddius Haas

Sr. Director Tax Lehigh Hanson, Inc.

Thaddius Haas is Sr. Director Tax for Lehigh Hanson, Inc., a wholly-owned subsidiary of HeidelbergCement, the global market leader in aggregates and a prominent player in the fields of cement, concrete, and other downstream activities.

Haas has been with the company since February of 2016.

Amy Yi

***Associate General Counsel and Director of Legal Operations
Lehigh Hanson, Inc.***

Amy Yi is Associate General Counsel and Director of Legal Operations for Lehigh Hanson, Inc. Lehigh Hanson, Inc. is a wholly-owned subsidiary of HeidelbergCement, the global market leader in aggregates and a prominent player in the fields of cement, concrete, and other downstream activities.

Yi has been with the company since 2006 and has held various positions over the years.

Section C.3

CERTIFICATE OF ASSISTANT SECRETARY
OF
CONTINENTAL FLORIDA MATERIALS INC.

I, AMY C. YI, do hereby certify that I am a duly elected, qualified and acting Assistant Secretary of CONTINENTAL FLORIDA MATERIALS INC., a Florida corporation (the "Company"), do hereby certify as follows:

1. Henner Boettcher was appointed as Vice President and Chief Financial Officer of the Company, effective as of March 19, 2015.
2. Henner Boettcher was appointed as Director of the Company, effective as of January 1, 2017.
3. Phil Detwiler was appointed as Vice President and General Manager of the Company, effective as of September 12, 2011.
4. Thaddius Haas was appointed as Assistant Secretary of the Company, effective as of August 15, 2016.
5. Glenn T. Heller was appointed as Director and President of the Company, effective as of April 1, 2016.
6. Carol L. Lowry was appointed as Vice President and Secretary of the Company, effective as of January 1, 2017.
7. Jonathan P. Morrish was appointed as Chairman of the Company, effective as of April 1, 2016.
8. Jonathan P. Morrish was appointed as Director of the Company, effective as of May 1, 2015.
9. Rebecca Robbins was appointed as Treasurer of the Company, effective as of June 1, 2017.
10. Jonathan P. Morrish was removed as President of the Company, effective as of April 1, 2016.
11. William H. Venema was appointed as Vice President and Secretary of the Company, effective as of May 1, 2015.
12. William H. Venema was removed as Vice President and Secretary of the Company, effective as of December 31, 2016.
13. Amy Yi was appointed as Assistant Secretary of the Company, effective as of June 2, 2008.

IN WITNESS WHEREOF, the undersigned has hereunto subscribed her name and affixed hereto the official seal of the Company on this 17th day of February, 2019.



[CORPORATE SEAL]



Amy C. Yi
Assistant Secretary

CERTIFICATE OF ASSISTANT SECRETARY
OF
CONTINENTAL FLORIDA MATERIALS INC.

I, AMY C. YI, do hereby certify that I am the duly elected, qualified and acting Assistant Secretary of CONTINENTAL FLORIDA MATERIALS INC., a Florida corporation (the "Company"), do hereby certify as follows:

1. Henner Boettcher was appointed as Vice President and Chief Financial Officer of the Company, effective as of March 19, 2015.
2. Phil Detwiler was appointed as Vice President and General Manager of the Company, effective as of September 12, 2011.
3. Glenn T. Heller was appointed as President of the Company, effective as of April 1, 2016.
4. Carol L. Lowry was appointed as Vice President and Secretary of the Company, effective as of January 1, 2017.
5. Jonathan P. Morrish was removed as President of the Company, effective as of April 1, 2016.
6. William H. Venema was appointed as Vice President and Secretary of the Company, effective as of May 1, 2015.
7. William H. Venema was removed as Vice President and Secretary of the Company, effective as of December 31, 2016.

IN WITNESS WHEREOF, the undersigned has hereunto subscribed her name and affixed hereto the official seal of the Company on this 13th day of February, 2019.

[CORPORATE SEAL]



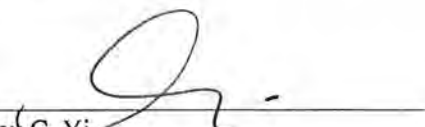

Amy C. Yi
Assistant Secretary

Section D

APPLICATION FOR REGISTRATION OF FICTITIOUS NAME

Note: Acknowledgements/certificates will be sent to the address in Section 1 only.

Section 1

1. Lehigh Cement Company
Fictitious Name to be Registered (see instructions if name includes "Corp" or "inc")

300 E. John Carpenter Fwy. #1645
Mailing Address of Business
Irving, TX 75062
City State Zip Code

3. Florida County of principal place of business: _____
Broward
(see instructions if more than one county)

FEI Number: _____

This space for office use only.

Section 2

A. Owner(s) of Fictitious Name If Individual(s): (Use an attachment if necessary):

1. _____ 2. _____
Last First M.I. Last First M.I.

Address Address

City State Zip Code City State Zip Code

B. Owner(s) of Fictitious Name If other than an individual: (Use attachment if necessary):

1. Continental Florida Materials Inc. 2. _____
Entity Name Entity Name

2600 Eisenhower Boulevard _____
Address Address

Ft. Lauderdale, FL 33316 _____
City State Zip Code City State Zip Code

Florida Document Number 466221 _____
Florida Document Number Florida Document Number

FEI Number: 59-1616110 _____
FEI Number FEI Number

Applied for Not Applicable Applied for Not Applicable

Section 3

I the undersigned, being an owner in the above fictitious name, certify that the information indicated on this form is true and accurate. In accordance with Section 865.09, F.S., I further certify that the fictitious name to be registered has been advertised at least once in a newspaper as defined in chapter 50, Florida Statutes, in the county where the principal place of business is located. I understand that the signature below shall have the same legal effect as if made under oath and I am aware that false information submitted in a document to the Department of State constitutes a third degree felony as provided for in s. 817.155, F.S.

[Signature] 04/04/2014
Signature of Owner Date

E-mail address: (to be used for future renewal notification)

Phone Number: _____

Section 4

**FOR CANCELLATION COMPLETE SECTION 4 ONLY:
 FOR FICTITIOUS NAME OR OWNERSHIP CHANGE COMPLETE SECTIONS 1 THROUGH 4:**

I (we) the undersigned, hereby cancel the fictitious name _____
 _____, which was registered on _____ and was assigned
 registration number _____

Signature of Owner Date

Signature of Owner Date

Mark the applicable boxes Certificate of Status — \$10 Certified Copy — \$30

NON-REFUNDABLE PROCESSING FEE: \$50

Section F

Business History and Corporation Relationships

Business History:

Continental Florida Materials Inc. (“CFM”) and its predecessor companies have been operating in Port Everglades, as well as other Florida seaports (Cape Canaveral and Jacksonville), for thirty-eight (38) years as cement importers and distributors. CFM has been a primary source of cement for the east coast of Florida. The services being applied for are for CFM’s internal use. CFM does not, and has not, used these services for contracting to other companies. CFM is in good standing within all of our Florida seaports.

Corporation Relationships:

At the time of CFM’s last application in 2009, CFM was a wholly-owned subsidiary of Lehigh Cement Company LLC (“Lehigh”). Lehigh was a wholly-owned subsidiary of HeidelbergCement AG (“HeidelbergCement”), located in Heidelberg, Germany.

In 2007, HeidelbergCement acquired Hanson PLC, creating a multi-national provider of cement, aggregates, ready mixed concrete and other construction materials. This purchase had no impact on CFM. CFM became a wholly-owned subsidiary of a newly named company, Lehigh Hanson, Inc. (“Lehigh Hanson”) CFM’s Florida management has not changed since our last filing in 2002.

In 2016, HeidelbergCement completed the acquisition of Italcementi. In North America, Essroc, a subsidiary of Italcementi that operated cement, ready mixed concrete and aggregate facilities, was integrated into the Lehigh Hanson businesses.

Today, Lehigh, Essroc and Hanson business in North America are collectively known as Lehigh Hanson, Inc. with approximately 550 active locations.

Section G

Paul Stewart

Education

BSc Chemical Engineering, Queen's University, Canada

BA Chemistry, Queen's University, Canada

Professional Experience

Director of Terminal Operations & Logistics	Lehigh Cement (South Region)	2018	Present
Area Cement Operations Manager	Lehigh Cement (North Region)	2016	2018
VP of Operations	Essroc	2014	2016
Plant Manager	Essroc	2005	2014
Sr Project Manager	Essroc	2003	2005
Plant Manager	Holcim	2000	2003
Plant Manager	Blue Circle	1998	2000
Production Manager	Essroc	1995	1998
Process Engineer	Essroc	1989	1995

Carlos Gonzalez

Education

Master of Science, Mechanical Engineering, University of Missouri, Columbia, MO

BS Mechanical Engineering, Universidad Del Norte, Barranquilla, Colombia

Professional Experience

Terminal Manager	Continental Florida Materials	2016	Present
Florida Projects Manager	Titan America	2008	2016
US Logistics Manager	Argos USA	2005	2008
Terminal Manager	Argos USA	2001	2004
Director Project Eng	World Minerals	1996	2000
Project Manager	Cementos del Caribe (Argos)	1992	1996

Professional Certification

Professional Engineer FL 79615

Dennis Willover

Professional Experience

Assistant Terminal Mgr	Continental Florida Materials	2016	Present
Terminal Manager	Continental Florida Materials	2010	2016
Vessel & Dispatch Ops	Continental Florida Materials	2004	2010
Dispatch Operations	Continental Florida Materials	2000	2004

Section J



CERTIFICATE OF LIABILITY INSURANCE

DATE (MM/DD/YYYY)
12/07/2018

THIS CERTIFICATE IS ISSUED AS A MATTER OF INFORMATION ONLY AND CONFERS NO RIGHTS UPON THE CERTIFICATE HOLDER. THIS CERTIFICATE DOES NOT AFFIRMATIVELY OR NEGATIVELY AMEND, EXTEND OR ALTER THE COVERAGE AFFORDED BY THE POLICIES BELOW. THIS CERTIFICATE OF INSURANCE DOES NOT CONSTITUTE A CONTRACT BETWEEN THE ISSUING INSURER(S), AUTHORIZED REPRESENTATIVE OR PRODUCER, AND THE CERTIFICATE HOLDER.

IMPORTANT: If the certificate holder is an ADDITIONAL INSURED, the policy(ies) must have ADDITIONAL INSURED provisions or be endorsed. If SUBROGATION IS WAIVED, subject to the terms and conditions of the policy, certain policies may require an endorsement. A statement on this certificate does not confer rights to the certificate holder in lieu of such endorsement(s).

PRODUCER Marsh USA, Inc. 4400 Comerica Bank Tower 1717 Main Street Dallas, TX 75201-7357 Attn: Hanson.Request@marsh.com Fax: 212-948-5371 C 100	CONTACT NAME: PHONE (A/C, No, Ext): FAX (A/C, No): E-MAIL ADDRESS: <table border="1" style="width:100%; border-collapse: collapse;"> <tr> <th style="width:80%;">INSURER(S) AFFORDING COVERAGE</th> <th style="width:20%;">NAIC #</th> </tr> <tr> <td>INSURER A : Liberty Mutual Fire Insurance Company</td> <td>23035</td> </tr> <tr> <td>INSURER B : Liberty Insurance Corporation</td> <td>42404</td> </tr> <tr> <td>INSURER C :</td> <td></td> </tr> <tr> <td>INSURER D :</td> <td></td> </tr> <tr> <td>INSURER E :</td> <td></td> </tr> <tr> <td>INSURER F :</td> <td></td> </tr> </table>	INSURER(S) AFFORDING COVERAGE	NAIC #	INSURER A : Liberty Mutual Fire Insurance Company	23035	INSURER B : Liberty Insurance Corporation	42404	INSURER C :		INSURER D :		INSURER E :		INSURER F :	
INSURER(S) AFFORDING COVERAGE	NAIC #														
INSURER A : Liberty Mutual Fire Insurance Company	23035														
INSURER B : Liberty Insurance Corporation	42404														
INSURER C :															
INSURER D :															
INSURER E :															
INSURER F :															
INSURED Continental Florida Materials Inc. 2600 Eisenhower Boulevard Port Everglades, FL 33316															

COVERAGES **CERTIFICATE NUMBER:** HOU-003292831-28 **REVISION NUMBER:** 26

THIS IS TO CERTIFY THAT THE POLICIES OF INSURANCE LISTED BELOW HAVE BEEN ISSUED TO THE INSURED NAMED ABOVE FOR THE POLICY PERIOD INDICATED. NOTWITHSTANDING ANY REQUIREMENT, TERM OR CONDITION OF ANY CONTRACT OR OTHER DOCUMENT WITH RESPECT TO WHICH THIS CERTIFICATE MAY BE ISSUED OR MAY PERTAIN, THE INSURANCE AFFORDED BY THE POLICIES DESCRIBED HEREIN IS SUBJECT TO ALL THE TERMS, EXCLUSIONS AND CONDITIONS OF SUCH POLICIES. LIMITS SHOWN MAY HAVE BEEN REDUCED BY PAID CLAIMS.

INSR LTR	TYPE OF INSURANCE	ADDL SUBR INSD	WVVD	POLICY NUMBER	POLICY EFF (MM/DD/YYYY)	POLICY EXP (MM/DD/YYYY)	LIMITS
A	<input checked="" type="checkbox"/> COMMERCIAL GENERAL LIABILITY <input type="checkbox"/> CLAIMS-MADE <input checked="" type="checkbox"/> OCCUR GEN'L AGGREGATE LIMIT APPLIES PER: <input checked="" type="checkbox"/> POLICY <input type="checkbox"/> PRO-JECT <input type="checkbox"/> LOC OTHER:			TB2-631-509529-039	01/01/2019	01/01/2020	EACH OCCURRENCE \$ 1,000,000 DAMAGE TO RENTED PREMISES (Ea occurrence) \$ 250,000 MED EXP (Any one person) \$ 10,000 PERSONAL & ADV INJURY \$ 1,000,000 GENERAL AGGREGATE \$ 2,000,000 PRODUCTS - COMP/OP AGG \$ 2,000,000 \$
A	<input checked="" type="checkbox"/> AUTOMOBILE LIABILITY <input checked="" type="checkbox"/> ANY AUTO <input type="checkbox"/> OWNED AUTOS ONLY <input type="checkbox"/> SCHEDULED AUTOS <input checked="" type="checkbox"/> HIRED AUTOS ONLY <input checked="" type="checkbox"/> NON-OWNED AUTOS ONLY			AS2-631-509529-029	01/01/2019	01/01/2020	COMBINED SINGLE LIMIT (Ea accident) \$ 1,000,000 BODILY INJURY (Per person) \$ BODILY INJURY (Per accident) \$ PROPERTY DAMAGE (Per accident) \$ \$
	<input type="checkbox"/> UMBRELLA LIAB <input type="checkbox"/> OCCUR <input type="checkbox"/> EXCESS LIAB <input type="checkbox"/> CLAIMS-MADE DED RETENTION \$						EACH OCCURRENCE \$ AGGREGATE \$ \$
B	<input checked="" type="checkbox"/> WORKERS COMPENSATION AND EMPLOYERS' LIABILITY ANY PROPRIETOR/PARTNER/EXECUTIVE OFFICER/MEMBER EXCLUDED? (Mandatory in NH) If yes, describe under DESCRIPTION OF OPERATIONS below			WA7-63D-509529-019 (AOS) WC7-631-509529-059 (MN, WI)	01/01/2019 01/01/2019	01/01/2020 01/01/2020	<input checked="" type="checkbox"/> PER STATUTE <input type="checkbox"/> OTH-ER E.L. EACH ACCIDENT \$ 1,000,000 E.L. DISEASE - EA EMPLOYEE \$ 1,000,000 E.L. DISEASE - POLICY LIMIT \$ 1,000,000

DESCRIPTION OF OPERATIONS / LOCATIONS / VEHICLES (ACORD 101, Additional Remarks Schedule, may be attached if more space is required)
 Re: Approximately 4.91 acres of land out of Port Everglades Plat No. 13 as recorded in Plat Book 115 Page 12 in Broward County, FL together with approximately 20 Silos, a bagging warehouse (5,000 sq'), an office (6,561 sq') and other miscellaneous structures (5,475 sq') located at 2600 Eisenhower Boulevard, Port Everglades, Florida
 Certificate Holder is included as Additional Insured (except as respects all coverage afforded by the Workers' Compensation policy) with regards to claims arising out of the operations of the Named Insured, where required by written contract. The General Liability policy includes Named Peril Pollution Liability Coverage with Limited Offsite Pollution Liability Coverage (additional insured provision does not apply).

CERTIFICATE HOLDER Broward County, 1850 Eller Drive, Ft. Lauderdale, FL 33316	CANCELLATION SHOULD ANY OF THE ABOVE DESCRIBED POLICIES BE CANCELLED BEFORE THE EXPIRATION DATE THEREOF, NOTICE WILL BE DELIVERED IN ACCORDANCE WITH THE POLICY PROVISIONS. AUTHORIZED REPRESENTATIVE of Marsh USA Inc. Manashi Mukherjee <i>Manashi Mukherjee</i>
---	---

AGENCY CUSTOMER ID: CN102608882

LOC #: Dallas



ADDITIONAL REMARKS SCHEDULE

Page 2 of 2

AGENCY Marsh USA, Inc.		NAMED INSURED Continental Florida Materials Inc. 2600 Eisenhower Boulevard Port Everglades, FL 33316	
POLICY NUMBER		EFFECTIVE DATE:	
CARRIER	NAIC CODE		

ADDITIONAL REMARKS

THIS ADDITIONAL REMARKS FORM IS A SCHEDULE TO ACORD FORM,
FORM NUMBER: 25 FORM TITLE: Certificate of Liability Insurance

USL&H is included in workers' compensation, subject to policy terms and conditions.

**LONGSHORE AND HARBOR WORKERS'
COMPENSATION ACT COVERAGE ENDORSEMENT**

This endorsement applies only to work subject to the Longshore and Harbor Workers' Compensation Act in a state shown in the Schedule. The policy applies to that work as though that state were listed in Item 3.A. of the Information Page.

General Section C. **Workers' Compensation Law** is replaced by the following:

C. Workers' Compensation Law

Workers' Compensation Law means the workers or workmen's compensation law and occupational disease law of each state or territory named in Item 3.A. of the Information Page and the Longshore and Harbor Workers' Compensation Act (33 USC Sections 901-950). It includes any amendments to those laws that are in effect during the policy period. It does not include any other federal workers or workmen's compensation law, other federal occupational disease law or the provisions of any law that provide nonoccupational disability benefits.

Part Two (Employers Liability Insurance), C. Exclusions., exclusion 8, does not apply to work subject to the Longshore and Harbor Workers' Compensation Act.

This endorsement does not apply to work subject to the Defense Base Act, the Outer Continental Shelf Lands Act, or the Nonappropriated Fund Instrumentalities Act.

Schedule

<u>State</u>	<u>Longshore and Harbor Workers' Compensation Act Coverage Percentage</u>
--------------	---

REFER TO SCHEDULE GPO 2926 FOR STATES AND PERCENTAGES

The rates for classifications with code numbers not followed by the letter "F" are rates for work not ordinarily subject to the Longshore and Harbor Workers' Compensation Act. If this policy covers work under such classifications, and if the work is subject to the Longshore and Harbor Workers' Compensation Act, those non-F classification rates will be increased by the Longshore and Harbor Workers' Compensation Act Coverage Percentage shown in the Schedule.

Issued by Liberty Insurance Corporation 21814

For attachment to Policy No. WA7-63D-509529-019 Effective Date Premium \$

Issued to Lehigh Hanson, Inc.

POLICY NUMBER: TB2-631-509529-039

COMMERCIAL GENERAL LIABILITY
CG 20 10 04 13

THIS ENDORSEMENT CHANGES THE POLICY. PLEASE READ IT CAREFULLY.

**ADDITIONAL INSURED – OWNERS, LESSEES OR
CONTRACTORS – SCHEDULED PERSON OR
ORGANIZATION**

This endorsement modifies insurance provided under the following:

COMMERCIAL GENERAL LIABILITY COVERAGE PART

A. **Section II – Who Is An Insured** is amended to include as an additional insured the person(s) or organization(s) shown in the Schedule, but only with respect to liability for "bodily injury", "property damage" or "personal and advertising injury" caused, in whole or in part, by:

1. Your acts or omissions; or
2. The acts or omissions of those acting on your behalf;

in the performance of your ongoing operations for the additional insured(s) at the location(s) designated above.

However:

1. The insurance afforded to such additional insured only applies to the extent permitted by law; and
2. If coverage provided to the additional insured is required by a contract or agreement, the insurance afforded to such additional insured will not be broader than that which you are required by the contract or agreement to provide for such additional insured.

B. With respect to the insurance afforded to these additional insureds, the following additional exclusions apply:

This insurance does not apply to "bodily injury" or "property damage" occurring after:

1. All work, including materials, parts or equipment furnished in connection with such work, on the project (other than service, maintenance or repairs) to be performed by or on behalf of the additional insured(s) at the location of the covered operations has been completed; or

2. That portion of "your work" out of which the injury or damage arises has been put to its intended use by any person or organization other than another contractor or subcontractor engaged in performing operations for a principal as a part of the same project.

C. With respect to the insurance afforded to these additional insureds, the following is added to **Section III – Limits Of Insurance:**

If coverage provided to the additional insured is required by a contract or agreement, the most we will pay on behalf of the additional insured is the amount of insurance:

1. Required by the contract or agreement; or
2. Available under the applicable Limits of Insurance shown in the Declarations;

whichever is less.

This endorsement shall not increase the applicable Limits of Insurance shown in the Declarations.

SCHEDULE

**Name Of Additional Insured Person(s)
Or Organization(s):**

Location(s) Of Covered Operations

Broward County, 1850 Eller Drive, Ft. Lauderdale, FL
33316. This endorsement applies to the LN 04 07 06
05 Named Peril Pollution Liability Coverage

All job locations of the insured

Information required to complete this Schedule, if not shown above, will be shown in the Declarations.

POLICY NUMBER: TB2-631-509529-039

COMMERCIAL GENERAL LIABILITY
CG 20 37 04 13

THIS ENDORSEMENT CHANGES THE POLICY. PLEASE READ IT CAREFULLY.

ADDITIONAL INSURED – OWNERS, LESSEES OR CONTRACTORS – COMPLETED OPERATIONS

This endorsement modifies insurance provided under the following:

COMMERCIAL GENERAL LIABILITY COVERAGE PART
PRODUCTS/COMPLETED OPERATIONS LIABILITY COVERAGE PART

A. Section II – Who Is An Insured is amended to include as an additional insured the person(s) or organization(s) shown in the Schedule, but only with respect to liability for "bodily injury" or "property damage" caused, in whole or in part, by "your work" at the location designated and described in the Schedule of this endorsement performed for that additional insured and included in the "products-completed operations hazard".

However:

1. The insurance afforded to such additional insured only applies to the extent permitted by law; and
2. If coverage provided to the additional insured is required by a contract or agreement, the insurance afforded to such additional insured will not be broader than that which you are required by the contract or agreement to provide for such additional insured.

B. With respect to the insurance afforded to these additional insureds, the following is added to **Section III – Limits Of Insurance:**

If coverage provided to the additional insured is required by a contract or agreement, the most we will pay on behalf of the additional insured is the amount of insurance:

1. Required by the contract or agreement; or
2. Available under the applicable Limits of Insurance shown in the Declarations;

whichever is less.

This endorsement shall not increase the applicable Limits of Insurance shown in the Declarations.

SCHEDULE

**Name Of Additional Insured Person(s)
Or Organization(s):**

Location And Description Of Completed Operations

Broward County, 1850 Eller Drive, Ft. Lauderdale, FL
33316 This endorsement applies to the LN 04 07 06 05
Named Peril Pollution Liability Coverage

All job locations of the Insured

Information required to complete this Schedule, if not shown above, will be shown in the Declarations.

Section K

Interim Financial Report January to September 2018

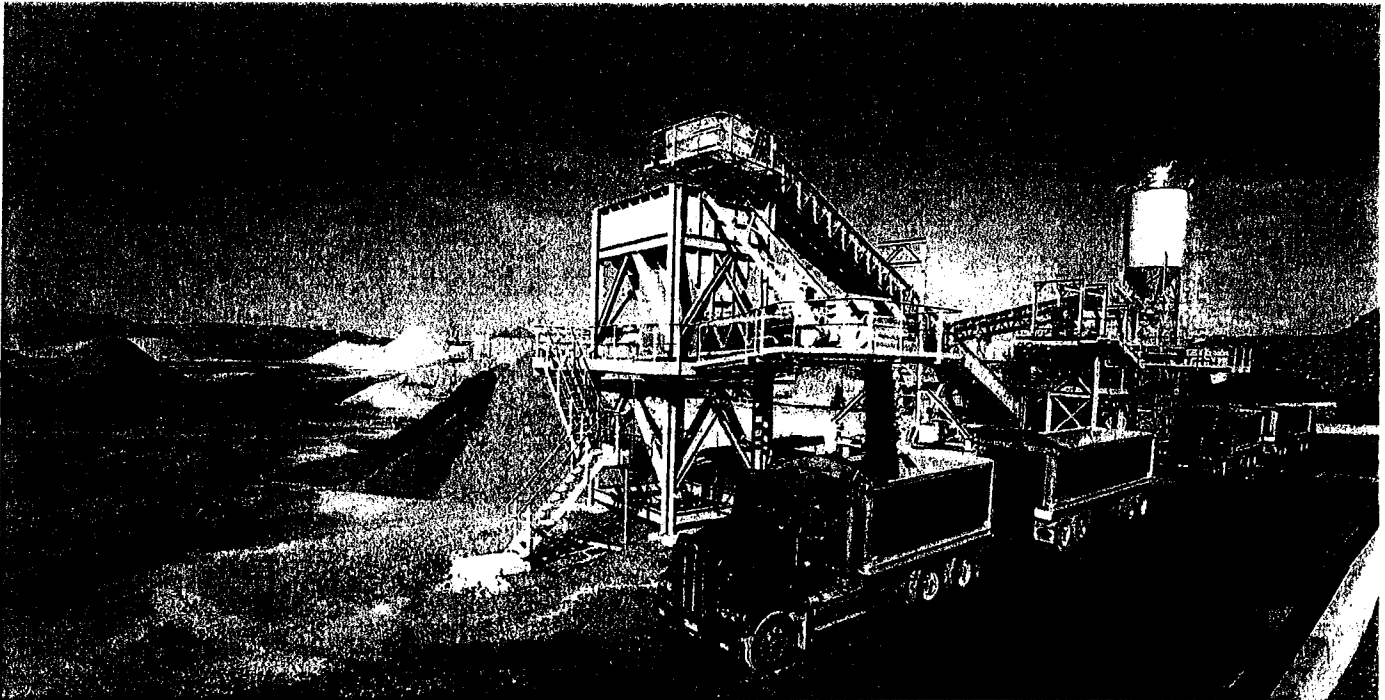

HEIDELBERGCEMENT

HeidelbergCement grows sales volumes, revenue and earnings per share – action plan initiated

- Growth in sales volumes in all business lines and positive pricing lead to organic revenue growth of 7 %
- Group share of profit and earnings per share improve by 19 % to €915 million (previous year: 768) and €4.61 (previous year: 3.87), respectively
- Action plan initiated focusing on three major levers:
 - Portfolio optimisation: Accelerate disposals and review further divestment potentials
 - Operational excellence: Launch of new efficiency programme focusing on SG&A expenses with a €100 million saving target
 - Cash flow and shareholder return: Adjust investment hurdle rate to share buyback valuation. Limit growth investments to an average of €350 million per year over the next two years.

Overview January to September 2018	July - September		January - September	
	2017	2018	2017	2018
€m				
Revenue	4,610	4,943	13,004	13,375
Result from joint ventures	62	63	141	151
Result from current operations before depreciation and amortisation (RCOBD)	1,058	1,039	2,405	2,227
RCOBD margin in %	23.0 %	21.0 %	18.5 %	16.6 %
Result from current operations	787	764	1,578	1,411
Additional ordinary result	-6	-34	-42	94
Result from participations	19	21	40	29
Earnings before interest and income taxes (EBIT)	800	750	1,576	1,534
Financial result	-104	-92	-285	-246
Profit before tax	697	658	1,291	1,287
Net income from continuing operations	521	587	891	1,028
Net loss from discontinued operations	-3	-7	-11	-12
Profit for the period	518	580	880	1,016
Group share of profit	481	539	768	915
Investments	265	242	785	1,216

Due to rounding, numbers presented in the Interim Financial Report may not add up precisely to the totals provided.

Interim Group management report

Business trend January to September 2018

Economic environment

Global economic growth is continuing, but the downside risks have increased. The national economies of Asia and the African countries south of the Sahara remain on a growth trajectory. In Europe, the economic recovery is progressing, albeit in a subdued manner. The US economy recorded once again strong growth in the third quarter.

Growth in sales volumes in all business lines in the first nine months

In the period from January to September 2018, the sustained positive market dynamics in all Group areas led to growth in sales volumes in all business lines.

The Group's cement and clinker sales volumes increased by 3.7 % to 97.0 million tonnes (previous year: 93.5). Excluding consolidation effects from the sale of the white cement activities in the USA, the deconsolidation of our activities in Georgia and the acquisition of Cementir Italia, the increase amounted to 3.9 %. The Asia-Pacific and Africa-Eastern Mediterranean Basin Group areas in particular contributed to this growth on a comparable basis, but also Northern and Eastern Europe-Central Asia. Deliveries in Western and Southern Europe as well as North America exceeded marginally the previous year's level.

Deliveries of aggregates rose by 1.7 % to 232.9 million tonnes (previous year: 229.0). Declining sales volumes in the Northern and Eastern Europe-Central Asia and Africa-Eastern Mediterranean Basin Group areas were more than offset by growth in Western and Southern Europe and particularly in North America and Asia-Pacific. Excluding consolidation effects, sales volumes increased by 1.1 %

Deliveries of ready-mixed concrete increased by 2.2 % to 35.8 million cubic metres (previous year: 35.0). With the exception of slight volume losses in Western and Southern Europe, all Group areas recorded growth in volumes. Excluding consolidation effects, the increase amounted to 3.3 %. Asphalt sales volumes rose significantly by 10.5 % to 7.8 million tonnes (previous

year: 7.1) owing to the positive development of demand in the United Kingdom and California as well as consolidation effects in the northwest of the USA and Australia. Excluding consolidation effects, the increase amounted to 3.5 %.

Development of revenue and results

Group revenue in the period from January to September 2018 rose slightly by 2.9 % in comparison with the previous year to €13,375 million (previous year: 13,004). Excluding consolidation and exchange rate effects, Group revenue increased by 7.4 %. Changes to the scope of consolidation of €39 million had a positive impact on revenue, while exchange rate effects reduced revenue by €575 million.

In the reporting period, material costs rose by 7.3 % to €5,496 million (previous year: 5,122). Excluding consolidation and exchange rate effects, material costs exceeded the previous year's level by 12.9 %. This rise predominantly related to the costs of energy and goods purchased for resale. The material cost ratio increased from 39.4 % to 41.1 %. Other operating expenses and income were 5.3 % above the previous year's level at €-3,544 million (previous year: -3,365). Excluding exchange rate and consolidation effects, the increase amounted to 9.0 %, which was essentially due to the rise in freight costs. Personnel costs decreased by 0.7 % to €2,251 million (previous year: 2,266). The result from joint ventures rose by 7.4 % to €151 million (previous year: 141).

The result from current operations before depreciation and amortisation fell by 7.4 % to €2,227 million (previous year: 2,405). The decrease of €178 million is primarily due to negative exchange rate effects of €121 million and changes to the scope of consolidation amounting to €-22 million. The decline of €36 million in operational terms is predominantly attributable to the rise in material costs. The result from current operations dropped by 10.6 % to €1,411 million (previous year: 1,578). Exchange rate effects of €-86 million and changes to the scope of consolidation of €-31 million reduced the result from current operations.

The additional ordinary result of €94 million (previous year: -42) primarily relates to income from the disposal of subsidiaries and other non-recurring expenses and income. In particular, income from the disposal of subsidiaries in Germany and the USA had a positive impact on the result.

Sales volumes

	July - September			January - September		
	2017	2018	Change	2017	2018	Change
Cement and clinker (Mt)	33.4	35.1	5.1 %	93.5	97.0	3.7 %
Aggregates (Mt)	86.6	87.7	1.3 %	229.0	232.9	1.7 %
Ready-mixed concrete (Mm ³)	12.4	12.9	3.6 %	35.0	35.8	2.2 %
Asphalt (Mt)	3.2	3.4	5.0 %	7.1	7.8	10.5 %

The financial result improved by €38 million to €-246 million (previous year: -285). Besides the reduction of €32 million in interest expenses, the financial result was positively affected by the improvement of €12 million in the other financial result. However, this was offset by the fall of €9 million in interest income.

Profit before tax from continuing operations deteriorated by €4 million to €1,287 million (previous year: 1,291). At €260 million (previous year: 400), expenses relating to taxes on income were 35.0% below the previous year's level. Net income from continuing operations improved by €136 million to €1,028 million (previous year: 891).

Net loss from discontinued operations of €-12 million (previous year: -11) is attributable to operations of the Hanson Group that were discontinued in previous years.

Overall, the profit for the period totals €1,016 million (previous year: 880). The profit attributable to non-controlling interests fell by €11 million to €101 million (previous year: 112). The Group share of profit therefore amounts to €915 million (previous year: 768).

Earnings per share – Group share – in accordance with IAS 33 improved by €0.74 to €4.61 (previous year: 3.87).

The statement of comprehensive income and the derivation of the earnings per share are shown in detail in the Notes.

Statement of cash flows

From January to September 2018, the cash inflow from operating activities of continuing operations fell by €214 million to €494 million (previous year: 708) compared with the same period of the previous year. This was primarily due to the decrease of €183 million in cash flow before interest and tax payments to €2,226 million (previous year: 2,410) and the rise of €196 million in working capital to €980 million (previous year: 784). Dividends received fell below the previous year's level at €159 million (previous year: 196) and mainly include payouts received from joint ventures and associates. Interest received decreased slightly by €10 million to €79 million (previous year: 89) in comparison with the same period of the previous year. Interest payments declined by €40 million to €393 million (previous year: 433) thanks to significantly more favourable refinancing conditions. At €196 million (previous year: 313), income taxes paid dropped considerably by €117 million in comparison with the same period of the previous year. In the reporting period, provisions of €241 million (previous year: 261) were utilised through payments.

Net cash used in investing activities of continuing operations rose in the reporting period by €225 million to €847 million (previous year: 623). Cash-relevant investments increased by €431 million to €1,216 million (previous year: 785), primarily as a result of business combinations in Italy, Australia, and

North America. Further details can be found in the Investments section and in the Business combinations in the reporting period section of the Notes on p. 21. The same period of the previous year saw the acquisition of aggregate pits and production sites for ready-mixed concrete and asphalt from Cemex in the northwest of the USA in exchange for a cash payment of €130 million, and the operating assets of the Saunders Companies in the US state of New York for the provisionally determined purchase price of €30 million, which was settled in cash and increased slightly by €0.6 million during the reporting period. With regard to the cash-relevant divestments of €344 million (previous year: 163), the cash inflow from the disposal of subsidiaries and other business units accounted for €254 million (previous year: 11): in particular, €109 million of this related to the sale of the sand-lime brick business in Germany and €115 million to the sale of Lehigh White Cement in the USA. Further details can be found in the Divestments in the reporting period section of the Notes on p. 23. Proceeds from the sale of other fixed assets essentially resulted from the sale of intangible assets and property, plant and equipment, the disposal of financial assets, joint ventures, and associates, and the repayment of loans. Changes to the scope of consolidation generated a cash inflow of €24 million (previous year: cash outflow of 0.4) in the reporting period, which largely comprised the cash and cash equivalents of €25 million taken over from the acquired Cementir companies in Italy.

Financing activities of continuing operations generated a cash inflow of €139 million (previous year: cash outflow of 406) in the reporting period. The cash inflow arising from the net proceeds from and repayment of bonds and loans of €712 million (previous year: 114) included in this figure covers the change in long-term and short-term interest-bearing liabilities and mainly comprises the issue of two bonds with a total value of €1.5 billion and the repayment of two bonds totalling €980 million. This item also includes the borrowings and payments relating to bank loans as well as changes to other short-term interest-bearing liabilities with a high turnover rate. In the same period of the previous year, three bonds with a total value of €2.25 billion were issued, while two bonds with a total value of €1.5 billion and one debt certificate of €285 million were repaid. Dividend payments led to an overall cash outflow of €553 million (previous year: 519), with HeidelbergCement AG dividend payments making up €377 million (previous year: 317) of this figure.

Investments

In the first nine months, cash-relevant investments rose to €1,216 million (previous year: 785). Investments in property, plant, and equipment (including intangible assets), which primarily relate to optimisation and environmental protection measures at our production sites, but also to expansion projects in growing markets, accounted for €610 million (previous year: 575) of this total. The investments in financial assets and other business units rose to €606 million (previous year: 210); this figure essentially relates to the acquisition of the

Italian cement and concrete manufacturer Cementir Italia and the Australian Alex Fraser Group, as well as the purchase of a cement plant in the Canadian province of Quebec and smaller bolt-on acquisitions of shareholdings.

At the same time, we sold our sand-lime brick business in Germany and the white cement activities in the USA as part of the optimisation of our portfolio. In addition, we sold a paper bag factory in Egypt and a former Cementir Italia cement plant to meet a condition imposed by the Italian competition authority. Cash-relevant divestments totalled €344 million in the first nine months (previous year: 163).

Balance sheet

As at 30 September 2018, the balance sheet total had grown by €1,141 million to €35,699 million (previous year: 34,558) in comparison with 31 December 2017.

Non-current assets increased by €410 million to €28,276 million (previous year: 27,865). The rise predominantly related to intangible assets of €288 million, financial assets of €48 million, and other non-current receivables of €127 million. This was offset by the decline in deferred tax assets of €50 million. The growth of €283 million in goodwill to €11,390 million (previous year: 11,107) was primarily the result of changes to the scope of consolidation in addition to exchange rate effects of €76 million.

Current assets increased by €808 million to €7,401 million (previous year: 6,593). The rise of €79 million in inventories to €1,960 million (previous year: 1,881) related in particular to raw materials and consumables. For revenue-related reasons, trade receivables grew by €724 million to €2,521 million (previous year: 1,798). Cash and cash equivalents fell by €239 million to €1,870 million (previous year: 2,109). The changes are explained in the Statement of cash flows section.

On the equity and liabilities side, equity rose by €469 million to €16,521 million (previous year: 16,052). The increase is particularly due to the profit for the period amounting to €1,016 million and the other comprehensive income of €161 million, which was primarily composed of actuarial gains of €94 million and currency translation differences of €91 million. Equity was impaired by dividend payments of €553 million and changes to the scope of consolidation and ownership interests in subsidiaries totalling €-144 million.

Interest-bearing liabilities grew by €603 million to €11,427 million (previous year: 10,824). The rise in net debt (interest-bearing liabilities less cash and cash equivalents) of €823 million to €9,518 million (previous year: 8,695) is due to the cash flows from investing activities, financing of the seasonal rise in receivables, and dividend payments. Total provisions decreased by €100 million to €2,537 million (previous year: 2,636). Of this amount, €55 million was attributable to pension provisions and €45 million to other provisions. The increase of €174 million in operating liabilities to €4,557 million

(previous year: 4,383) relates primarily to the rise of €81 million in trade payables to €2,362 million (previous year: 2,281) in addition to the growth of €77 million in other current operating liabilities to €1,568 million (previous year: 1,491).

Financing

On 12 January 2018, we signed a new €3 billion syndicated credit facility to refinance the existing credit facility which would have expired in February 2019. As there are two prolongation options of one year each, we secured the historically attractive refinancing conditions until 2025. The credit margin was reduced by 20 to 35 basis points, depending on the leverage. The syndicated credit facility is intended as liquidity back-up and can be used for cash drawdowns as well as for letters of credit and guarantees both in euro and in other currencies.

In the first nine months of 2018, HeidelbergCement issued two Eurobonds with a total volume of €1.5 billion under its €10 billion EMTN programme. The issue proceeds will be used for general corporate financing purposes and for the repayment of upcoming maturities.

On 24 April 2018, HeidelbergCement issued a Eurobond with an issue volume of €750 million and a ten-year term ending on 24 April 2028. The bond bears a fixed coupon of 1.750 % p.a. The issue price was at 98.870 %, resulting in a yield to maturity of 1.875 %.

On 9 August 2018, HeidelbergCement issued a further Eurobond of €750 million. The 4-year bond with a maturity date of 9 August 2022 bears a fixed coupon of 0.500 % p.a. The issue price was at 99.335 %, resulting in a yield to maturity of 0.669 %.

According to the terms and conditions of the bonds issued in 2009 and 2010, there is a limitation on incurring additional debt if the consolidated coverage ratio (i.e. the ratio of the aggregate amount of the consolidated EBITDA to the aggregate amount of the consolidated interest expense) of the HeidelbergCement Group is below 2. This covenant is suspended for the other bonds and debt certificates due to the investment grade rating. The consolidated EBITDA of €3,227 million and the consolidated interest expense of €425 million are calculated on a pro forma basis in accordance with the terms and conditions of the bonds. As at 30 September 2018, the consolidated coverage ratio amounted to 7.59.

The net debt decreased by €135 million in comparison with 30 September 2017, amounting to €9,518 million (previous year: 9,653) as at 30 September 2018. The increase of €823 million in comparison with the end of 2017 (€8,695 million) is primarily due to the acquisitions in Italy and Australia as well as the rise in working capital, related to seasonal factors, and the dividend payments in the second quarter.

Western and Southern Europe

The economic upturn continued in the countries of the Western and Southern Europe Group area, but has lost momentum due to political and economic uncertainties. Despite an expected slowdown in the third quarter, the German economy is in a robust shape as a result of the strong domestic demand and the healthy labour market. The economic recovery is also ongoing in Belgium and the Netherlands. In the United Kingdom, uncertainties resulting from the faltering Brexit negotiations continue to impact the economic development and construction activity. In France, economic growth rose to 0.4 % in the third quarter. While Spain remains on course for growth with a rise in GDP of 0.6 %, the Italian economy stagnated in the third quarter.

In the first nine months of 2018, the Western and Southern Europe Group area's cement and clinker sales volumes rose by 5.6 % to 23.0 million tonnes (previous year: 21.8). This growth is mainly attributable to the newly included cement activities of Cementir in Italy and increased volumes in France and Spain. Excluding consolidation effects, deliveries increased marginally by 0.3 %. Even excluding consolidation effects, sales volumes grew moderately in Italy. In Germany, Belgium/Netherlands and the United Kingdom, our deliveries remained slightly below the previous year's level.

In the aggregates business line, slight increases in sales volumes in Belgium/Netherlands, the United Kingdom, France and Spain more than made up for the significant volume loss in Italy. In Germany, our deliveries were at the level of the previous year. Overall, the Group area's aggregates sales volumes increased slightly by 1.2 % in the first nine months to 60.4 million tonnes (previous year: 59.7).

Ready-mixed concrete sales volumes decreased slightly by 0.8 % to 12.9 million cubic metres (previous year: 13.0). While we achieved a significant rise in sales volumes in Italy and our deliveries also increased in France and Spain, volumes fell in Germany, Belgium/Netherlands, and the United Kingdom. The sales volumes of the asphalt operating line in the United Kingdom rose by 11.0 % compared with the previous year.

To expand our market position in Italy, our subsidiary Italcementi S.p.A. acquired from Cementir Holding 100 % of the shareholding in Cementir Italia S.p.A. and its subsidiaries, Cementir Sacci S.p.A. and Betontir S.p.A., on 2 January 2018. The acquisition comprises five cement and two cement grinding plants as well as a network of terminals and ready-mixed concrete plants. Due to the conditions imposed by the Italian competition authority, Italcementi S.p.A. sold the cement plant in Maddaloni via the acquired subsidiary Cementir Italia S.p.A. on 1 June 2018.

As part of the optimisation of our portfolio, we sold our sand-lime brick business in Germany – including a plant Switzerland – to the Danish company H+H International A/S on 28 February 2018.

Revenue of the Western and Southern Europe Group area rose by 3.5 % to €3,678 million (previous year: 3,555). Excluding consolidation and exchange rate effects, growth amounted to 3.4 %.

Northern and Eastern Europe-Central Asia

The Nordic countries continue to record an overall positive economic development and strong construction activity. In Poland and Czechia, the upturn in the economy and in construction activity is ongoing. The Romanian economy is also on a course for growth, but there is still a lack of infrastructure projects and public investments. The economies of Ukraine and Russia are recovering, but the armed conflict in eastern Ukraine is continuing to impact both countries severely.

During the first nine months, cement and clinker deliveries of the Northern and Eastern Europe-Central Asia Group area fell by 2.7 % to 19.3 million tonnes (previous year: 19.8) as a result of consolidation. Excluding the effects of the deconsolidation of our activities in Georgia, the increase in sales volumes amounted to 3.7 %. Growth in volumes in Sweden and Iceland did not fully compensate for volume losses in Norway and Denmark, which led to overall deliveries of the Northern European countries remaining just under the previous year's level. In Eastern Europe-Central Asia, the deliveries of the individual countries also presented a mixed picture. While our sales volumes declined in Bulgaria, Russia, as well as Ukraine and remained stable in Romania, Czechia and Poland achieved a substantial rise in volumes. In Greece and Kazakhstan, our deliveries also exceeded the previous year's level. As a whole, Eastern Europe-Central Asia recorded a moderate increase in sales volumes, excluding the Georgia effect.

Our deliveries in the aggregates business line declined slightly by 0.8 % to 38.7 million tonnes (previous year: 39.1). In Northern Europe, a strong increase in volumes in Sweden and gains of the Mibau Group largely offset the decrease in volumes in Norway, Iceland, and the Baltic States. In Eastern Europe-Central Asia, growth in sales volumes in Poland, Czechia, Romania, Ukraine, Slovakia, and Greece stood in contrast to the dip in volumes in Kazakhstan and Russia.

Deliveries of ready-mixed concrete rose slightly by 1.1 % to 5.1 million cubic metres (previous year: 5.0). Adjusted for the effects of the deconsolidation of our activities in Georgia, deliveries grew by 11.7 %. Overall, the Northern European countries achieved a significant increase in sales volumes. Poland, Czechia, Romania, Slovakia, and Greece also recorded a substantial growth in volumes.

Revenue of the Northern and Eastern Europe-Central Asia Group area improved by 1.2 % to €2,163 million (previous year: 2,138); excluding consolidation and exchange rate effects, the growth amounted to 8.7 %.

North America

In the North America Group area, HeidelbergCement is represented in the USA and Canada. The US economy recorded once again strong growth in the third quarter. Gross domestic product increased by 3.5 % according to a preliminary estimate. Nonresidential investment also contributed to economic growth in the third quarter, while residential investment declined. The labour market is in very good shape and the economic outlook continues to be positive.

In the first nine months of 2018, sales volumes of our building materials were significantly impaired by adverse weather conditions. The long, hard winter impacted significantly construction activity until mid-April, particularly in the north-east of the USA. In September, our deliveries suffered from unusually wet weather in Texas as well as in the midwest and northeast of the USA.

The cement sales volumes of our North American plants decreased by 1.7 % to 12.1 million tonnes (previous year: 12.3) in the first nine months. Excluding consolidation effects from the purchase of a cement plant and the sale of the white cement business, sales volumes exceeded marginally by 0.2 % the previous year's level. The Canada region recorded a pleasing increase in volumes, thanks to the high level of demand on the west coast. The West region benefited from lively construction activity, particularly in California, and achieved substantial growth in sales volumes. Despite heavy rains in the second and third quarter, the volume losses caused by bad weather during the first few months were more than recovered in the South region. In contrast, volumes in the North region declined due to the inclement weather conditions in winter and spring as well as in September. Price increases were successfully implemented in all key markets of both the United States and Canada.

As part of our portfolio optimisation, we sold our 51 % participation in Lehigh White Cement Company, Harrisburg, to the non-controlling shareholders Aalborg Cement Company, Inc. and Cemex, Inc. on 29 March 2018. Lehigh White Cement Company operates two white cement plants in Waco, Texas, and York, Pennsylvania, with an annual production capacity totalling around 255,000 tonnes. On 7 February 2018, we acquired a cement plant in the Canadian province of Quebec.

In the aggregates business line, the Canada, South and West regions achieved growth in sales volumes, while deliveries in the North region remained at the level of the previous year due to weather-related reasons. Overall, aggregate sales volumes grew in the first nine months by 2.9 % to 93.2 million tonnes (previous year: 90.6). Excluding consolidation effects in the North and Canada regions, the rise amounted to 1.1 %. Sales prices were increased in all regions.

In the ready-mixed concrete operating line, the deliveries of the North region decreased as a result of unfavourable weather conditions and consolidation effects. In contrast,

the South region achieved slight and the Canada and West regions significant increases in volumes, with total ready-mixed concrete sales volumes growing by 5.6 % to 5.3 million cubic metres (previous year: 5.0). Excluding consolidation effects in the North, South, and Canada regions, the increase amounted to 2.1 %.

To strengthen the vertical integration in the Southeast, we acquired the ready-mixed concrete producer Fairburn Ready-Mix on 6 April 2018. Fairburn Ready-Mix operates five ready-mixed concrete plants in the Atlanta metropolitan area and complements our existing cement and aggregates businesses in Georgia.

Asphalt deliveries rose by 6.9 % to 3.2 million tonnes (previous year: 3.0) thanks to good market conditions in the West region. Excluding consolidation effects in the Canada region, sales volumes grew by 3.7 %.

In the service-joint ventures-other business line, the cement sales volumes of our joint venture Texas Lehigh Cement were below the previous year's level as a result of the unfavourable weather conditions.

Total revenue in North America fell by 3.8 % to €3,179 million (previous year: 3,305); excluding consolidation and exchange rate effects, revenue increased by 2.9 %.

Asia-Pacific

Despite the restructuring and slowdown of the Chinese economy, the emerging countries of Asia remain on course for growth. The Chinese economy weakened more than expected in the third quarter, with growth of 6.5 % in gross domestic product. In Indonesia, the economy is showing robust growth. A slight acceleration in economic growth is anticipated in India and Thailand. Despite weak investments in the raw materials sector, Australia is showing robust economic development.

During the first nine months, cement and clinker deliveries of the Asia-Pacific Group area rose by 7.8 % to 27.3 million tonnes (previous year: 25.3).

In Indonesia, cement and clinker sales volumes of our subsidiary Indocement rose by 6.6 % in the first nine months. Price development showed a clear turnaround in the third quarter and further price increases were announced in October. Indocement continues to pursue strict cost management to counteract the rise in logistics and production costs due to inflation in energy costs and the devaluation of the local currency.

In India, the cement and clinker deliveries of our central and southern Indian plants rose considerably in the first nine months owing to the strong demand, particularly from the infrastructure sector. While our plants in central India benefited from a positive development in prices, the markets

in southern India continued to be subject to price pressure. The rise in the cost of fuel was partially offset by the increase in power generated by our waste heat power station in the Damoh cement plant.

Supported by the commencement of major infrastructural projects, Thailand's domestic cement market started to recover in the second quarter. The deliveries of our plants also improved and recorded a slight increase by the end of the reporting period. The sharp rise in export deliveries also contributed to the growth in sales volumes. Despite cost inflation, margins improved as a result of the positive price development. In Bangladesh, our cement deliveries recorded a pleasing increase.

In the aggregates business line, our deliveries rose by 7.2 % to 32.9 million tonnes (previous year: 30.7). In Australia, the ongoing lively construction activity, particularly on the east coast, led to a significant growth in sales volumes. The previous strong demand from residential construction has declined, but is replaced by growth in the infrastructure sector. While our deliveries in Indonesia declined and remained at the level of the previous year in Malaysia, Thailand achieved a strong increase in volumes.

At 8.3 million cubic metres (previous year: 7.9), sales volumes in the ready-mixed concrete operating line exceeded the previous year's level by 5.1 %. Australia was the biggest contributor to the increase, but Indonesia, Malaysia, and Thailand in particular also recorded a positive development of sales volumes.

The sales volumes of the asphalt operating line rose by 24.3 % on account of consolidation effects in Australia. Excluding consolidation effects, sales volumes fell by 8.2 % as a result of the weak demand in Malaysia.

In China, the cement deliveries of our joint ventures in the provinces of Guangdong and Shaanxi remained just under the previous year's level. In contrast, our joint venture Cement Australia achieved pleasing growth in sales volumes.

On 31 January 2018, we acquired the Alex Fraser Group, Australia's leading recycler of building materials, from Swire Investments (Australia) Ltd. This transaction strengthens our market positions in the Melbourne and Brisbane metropolitan areas. The company operates three production sites in Melbourne and two in Brisbane, in addition to producing asphalt at two plants in Melbourne. We also acquired the Suncoast Asphalt Pty Ltd group, a manufacturer of asphalt in the South East Queensland region, on 29 March 2018.

Revenue of the Asia-Pacific Group area increased by 0.2 % to €2,366 million (previous year: 2,361); excluding consolidation and exchange rate effects, revenue rose by 6.0 %.

Africa-Eastern Mediterranean Basin

Overall, the African countries south of the Sahara are continuing to experience robust economic growth and lively construction activity. Despite political risks, Egypt is expected to gather significant economic momentum. In contrast, the outlook for Morocco has somewhat deteriorated. In Turkey, the economic development suffers from the high inflation, the currency crisis and the resulting loss of confidence.

The cement and clinker sales volumes of the Africa-Eastern Mediterranean Basin Group area, which only includes the deliveries from our African subsidiaries, grew by 6.5 % to 14.9 million tonnes (previous year: 14.0). In most countries south of the Sahara, we recorded considerable increases in volumes thanks to lively construction activity. Ghana, Tanzania, and Sierra Leone made particularly strong contributions to this growth in sales volumes. In Ghana, our main market, our deliveries benefited from the strong demand particularly from residential construction. We also recorded pleasing increases in sales volumes in Benin, Liberia, Mozambique, and particularly in the Democratic Republic of Congo. Despite the positive development of domestic volumes, deliveries in Togo remained slightly below the previous year's level as a result of the strong decline in exports in the first half of the year. Overall, the North African countries also achieved a moderate growth in sales volumes. The substantial rise in Egypt outweighed the slight dip in Morocco.

In light of the good growth prospects, HeidelbergCement is expanding its activities in Africa. In February 2018, we laid the foundation stone for the construction of a second cement mill in Burkina Faso; this will double the capacity of our cement grinding plant, located near the capital Ouagadougou, to around 2 million tonnes. In the Democratic Republic of Congo, we are continuing with the expansion of our Cimenterie de Lukala cement plant. The new kiln line at the plant near Kinshasa will be completed by the end of 2019.

In September 2018, our Egyptian subsidiary Helwan Cement entered into an agreement with Emaar Industries to sell its white cement plant in Minya. The disposal is part of our portfolio optimization. The closing of the transaction is subject to customary conditions as well as the de-merger of the white cement plant from Helwan Cement and is expected to occur in the fourth quarter of 2018 or in the first quarter of 2019.

Aside from minor activities in some African countries south of the Sahara, HeidelbergCement is predominantly active in Israel and Morocco in the aggregates business line. While deliveries in Morocco increased significantly, production and sales volumes in Israel declined due to the expiry of a mining concession. Deliveries of aggregates decreased overall by 13.7 % to 7.8 million tonnes (previous year: 9.1). In the ready-mixed concrete operating line, HeidelbergCement is represented in Israel, Egypt, and Morocco. Ready-mixed concrete sales volumes grew by 3.7 % to 3.9 million cubic metres (previous year: 3.7). Asphalt activities in Israel recorded a decline in volumes of 6.1 %.

The service-joint ventures-other business line essentially includes the cement, aggregates, and ready-mixed concrete activities of our Turkish joint venture Akçansa. Lower domestic cement deliveries were partially offset by the growth in exports. Overall, the cement and clinker sales volumes of Akçansa declined by 5.2 % in the first nine months. While deliveries of aggregates declined substantially, sales volumes of ready-mixed concrete remained just under the level of the previous year.

Revenue of the Africa-Eastern Mediterranean Basin Group area grew by 6.0 % to €1,250 million (previous year: 1,179); excluding consolidation and exchange rate effects, the increase amounted to 12.6 %.

Group Services

Group Services comprises the activities of our subsidiary HC Trading, one of the largest international trading companies for cement and clinker. The company is also responsible for purchasing and delivering coal and petroleum coke via sea routes to our own locations and to other cement companies around the world. Group Services also includes our cement and ready-mixed concrete activities in Kuwait.

In the first nine months, the overall trade volume of HC Trading rose significantly by 16.6 % to a record value of 22.7 million tonnes (previous year: 19.5). Deliveries of cement, clinker, and other building materials such as lime and dry mortar increased by 3.8 % to 13.8 million tonnes (previous year: 13.2). Trade in coal and petroleum coke recorded strong growth of 43.6 % to 9.0 million tonnes (previous year: 6.2).

Revenue of the Group Services business unit rose by 29.0 % to €1,277 million (previous year: 990); excluding consolidation and exchange rate effects, the increase amounted to 28.2 %.

Employees

At the end of September 2018, the number of employees at HeidelbergCement stood at 59,589 (previous year: 60,830). The decrease of 1,241 employees essentially results from two opposing developments. On the one hand, more than 2,900 jobs were cut across the Group as a result of portfolio optimisations, the realization of synergies, efficiency increases in sales and administration as well as location optimisations. On the other hand, just under 1,700 new employees joined the Group, particularly as a result of the company acquisitions in Italy and Australia in the first quarter of 2018. Furthermore, there was an increase in some countries in the Western and Southern Europe and Northern and Eastern Europe-Central Asia Group areas, and in particular in Australia, owing to the solid market development.

Personnel change in the Supervisory Board of HeidelbergCement

Mr Frank-Dirk Steininger, employee representative on the Supervisory Board (nominated by the trade union) resigned from the Supervisory Board with effect from 31 January 2018. Following an application of the company, the Local Court (Amtsgericht) of Mannheim/Germany supplemented the Supervisory Board by appointing Ms Barbara Breuninger, nominated by the relevant trade union, as a member in the

capacity of employee representative with effect from 5 April 2018. Her term of appointment will expire at the end of the term of the other members of the Supervisory Board, i.e. with the conclusion of the 2019 Annual General Meeting.

With the appointment of Ms Breuninger, the Supervisory Board of HeidelbergCement AG consists of eight men and four women, so that the legal requirement regarding the minimum share of at least 30 % each of woman and men on the Supervisory Board is fulfilled.

Events after the balance sheet date

After the balance sheet date, there were no reportable events.

Outlook

HeidelbergCement partially adapted its outlook for the 2018 financial year on 18 October 2018.

Sales volumes and revenue of the first nine months of 2018 developed in line with expectations and the guidance for the full year remains unchanged.

However, the outlook for 2018 for RCOBD, adjusted for currency and consolidation effects, was adapted to a low to mid single-digit percentage decline (previously: a mid to high single-digit percentage increase). Reason for the adjustment is – besides persistent adverse weather conditions in the core markets of HeidelbergCement in the USA – among others an energy cost inflation that significantly exceeded our expectations and could only partially be compensated by price increases over the course of the year. We expect now energy costs to increase by a high single to low double-digit percentage. In addition, gains from the sale of depleted quarries are anticipated to be lower than in the prior year. Cash-relevant net investments are expected to amount to €1.3 billion for the full year, slightly higher than the €1.1 billion originally planned. Consequently, we expect now that the leverage at year-end will rise to just above the so far anticipated value of 2.5x.

Outlook for Group share of profit for the year 2018 remains unchanged, which means we continue to expect a significant increase.

In light of the weaker than expected operational result development, we take strong actions to drive earnings and cash flow generation. We remain committed to improving shareholder value and maintaining a solid investment grade rating.

The company has initiated an action plan with focus on three levers: portfolio optimisation, operational excellence as well as cash flow and shareholder return.

- **Portfolio optimisation:** Accelerate disposals and review further divestment potentials.
- **Operational excellence:** Launch of a new efficiency programme focusing on selling, general & administrative expenses with a €100 million savings target over the next two years. Start of an aggressive commercial excellence initiative to regain margins by significant price increases.
- **Cash flow and shareholder return:** Adjust investment hurdle rate to share buyback valuation. Limit growth investments to an average of €350 million per year for the next two years. Share buyback to be considered in mid-2019.

Further details of the portfolio optimisation and operational excellence initiatives will be announced with the full year 2018 results in March 2019.

Additional statements on the outlook

The Managing Board of HeidelbergCement has not seen evidence of developments beyond those mentioned in the previous paragraph that would suggest changes for the business year 2018 regarding the forecasts and other statements made in the 2017 Annual Report in the Outlook chapter on page 66 ff. on the expected development of HeidelbergCement and its business environment.

The expected future development of HeidelbergCement and the business environment over the course of 2018 is described in the outlook. As such, please note that this Interim Financial Report contains forward-looking statements based on the information currently available and the current assumptions and forecasts of the Managing Board of HeidelbergCement. Such statements are naturally subject to risks and uncertainties and may therefore deviate significantly from the actual development. HeidelbergCement undertakes no obligation and furthermore has no intention to update the forward-looking statements made in this Interim Financial Report.

Risk and opportunity report

HeidelbergCement's risk policy is based on the business strategy, which focuses on safeguarding the Group's existence and sustainably increasing its value. Entrepreneurial activity is always forward-looking and therefore subject to certain risks. Identifying risks, understanding them, as well as assessing and reducing them systematically are the responsibility of the Managing Board and a key task for all managers. HeidelbergCement is subject to various risks that are not fundamentally avoided, but instead accepted, provided they are consistent with the legal and ethical principles of entrepreneurial activity and are well balanced by the opportunities they present. Opportunity and risk management at HeidelbergCement is closely linked by Group-wide planning and monitoring systems. Opportunities are recorded in the annual operational plan and followed up as part of monthly financial reporting. Operational management in each country and the central Group departments are directly responsible for identifying and observing opportunities at an early stage.

In a holistic view of individual risks and the overall risk situation, there are, from today's perspective, no identifiable risks that could threaten the existence of the Group or any other apparent significant risks. Our control and risk management system standardised across the Group ensures that major risks, which, if they occurred, would lead to a considerable deterioration of the Group's economic position, are identified at an early stage.

Risks that may have a significant impact on our financial position and performance in the 2018 financial year and in the foreseeable future as well as the opportunities are described in detail in the 2017 Annual Report in the risk and opportunity report chapter on page 73 ff.

The risks arising from volatile energy and raw material prices as well as from exchange rates remain high. Geopolitical risks result in particular from the political crises and armed conflicts in the Middle East and in eastern Ukraine. Macroeconomic risks include in particular the danger of escalating trade conflicts. Uncertainties still remain with regard to the stability of the global financial system.

Interim consolidated financial statements

Consolidated income statement

€m	July - September		January - September	
	2017	2018	2017	2018
Revenue	4,609.6	4,943.3	13,003.9	13,375.0
Change in finished goods and work in progress	37.5	20.6	8.4	-16.3
Own work capitalised	1.6	2.7	5.5	8.6
Operating revenue	4,648.6	4,966.6	13,017.8	13,367.2
Other operating income	121.3	169.5	376.7	344.7
Material costs	-1,783.8	-2,003.1	-5,121.9	-5,495.9
Employee and personnel costs	-743.0	-759.4	-2,266.2	-2,251.4
Other operating expenses	-1,247.0	-1,397.8	-3,741.7	-3,888.8
Result from joint ventures	61.9	62.8	140.6	151.0
Result from current operations before depreciation and amortisation (RCOBD)	1,058.0	1,038.6	2,405.3	2,226.8
Depreciation and amortisation	-270.8	-274.8	-827.0	-816.0
Result from current operations	787.2	763.8	1,578.3	1,410.8
Additional ordinary income	42.2	4.7	46.3	177.7
Additional ordinary expenses	-47.7	-39.0	-88.3	-84.0
Additional ordinary result	-5.6	-34.3	-42.0	93.7
Result from associates	17.7	19.2	35.1	27.5
Result from other participations	1.1	1.5	4.6	1.8
Result from participations	18.8	20.7	39.6	29.3
Earnings before interest and taxes (EBIT)	800.4	750.1	1,575.9	1,533.7
Interest income	10.2	11.4	44.5	35.4
Interest expenses	-90.6	-81.5	-272.4	-240.1
Foreign exchange gains and losses	-3.5	-3.9	2.1	5.4
Other financial result	-19.8	-17.7	-59.0	-47.1
Financial result	-103.7	-91.7	-284.8	-246.4
Profit before tax from continuing operations	696.8	658.5	1,291.1	1,287.4
Income taxes	-175.7	-71.4	-400.0	-259.9
Net income from continuing operations	521.1	587.1	891.2	1,027.5
Net loss from discontinued operations	-2.7	-6.6	-10.7	-11.7
Profit for the period	518.5	580.5	880.4	1,015.8
Thereof non-controlling interests	37.8	41.1	112.2	101.2
Thereof Group share of profit	480.7	539.4	768.3	914.6
Earnings per share in € (IAS 33)				
Earnings per share attributable to the parent entity	2.42	2.72	3.87	4.61
Earnings per share – continuing operations	2.44	2.75	3.93	4.67
Loss per share – discontinued operations	-0.02	-0.03	-0.06	-0.06

Consolidated statement of comprehensive income

€m	July - September		January - September	
	2017	2018	2017	2018
Profit for the period	518.5	580.5	880.4	1,015.8
Other comprehensive income				
Items not being reclassified to profit or loss in subsequent periods				
Remeasurement of the defined benefit liability (asset)	26.5	-13.8	33.9	133.0
Income taxes	-8.3	4.2	-10.6	-39.4
Defined benefit plans	18.2	-9.6	23.3	93.6
Items that may be reclassified subsequently to profit or loss				
Cash flow hedges – change in fair value	-4.6	-0.3	-8.3	3.4
Reclassification adjustments for gains/losses included in profit or loss	5.7	0.5	10.1	-2.4
Income taxes	-0.2	-0.2	0.0	-0.5
Cash flow hedges	0.9	0.0	1.8	0.5
Currency translation	-543.3	21.2	-1,886.0	108.3
Income taxes	-2.4	-1.1	5.7	-6.5
Currency translation	-545.7	20.1	-1,880.3	101.8
Net gains/losses arising from equity method investments	-16.9	-27.6	-42.7	-35.2
Total	-561.6	-7.6	-1,921.2	67.2
Other comprehensive income	-543.4	-17.1	-1,897.8	160.8
Total comprehensive income	-25.0	563.4	-1,017.4	1,176.6
Thereof non-controlling interests	-7.9	30.1	-20.4	68.1
Thereof Group share	-17.1	533.3	-997.0	1,108.5

Consolidated statement of cash flows

€m	July - September		January - September	
	2017	2018	2017	2018
Net income from continuing operations	521.1	587.1	891.2	1,027.5
Income taxes	175.7	71.4	400.0	259.9
Interest income/ expenses	80.4	70.1	227.9	204.7
Dividends received	45.9	51.2	196.4	159.3
Interest received	26.4	27.5	88.8	79.1
Interest paid	-35.1	-35.1	-433.2	-393.4
Income taxes paid	-51.2	-53.1	-313.0	-196.2
Depreciation, amortisation, and impairment	274.4	276.0	830.6	835.2
Elimination of other non-cash items	-55.9	-60.9	-136.2	-260.1
Cash flow	981.5	934.0	1,752.5	1,715.9
Changes in operating assets	27.6	-180.8	-618.9	-990.4
Changes in operating liabilities	-83.3	54.3	-165.1	10.0
Changes in working capital	-55.7	-126.5	-784.0	-980.4
Decrease in provisions through cash payments	-89.7	-85.8	-260.6	-241.2
Cash flow from operating activities - continuing operations	836.1	721.8	707.9	494.3
Cash flow from operating activities - discontinued operations	0.0	-0.4	-3.3	-0.8
Cash flow from operating activities	836.1	721.4	704.6	493.5
Intangible assets	-2.0	-4.9	-8.8	-13.1
Property, plant and equipment	-206.8	-188.0	-565.9	-596.5
Subsidiaries and other business units	-29.3	-39.4	-160.4	-573.1
Other financial assets, associates, and joint ventures	-27.2	-9.3	-50.0	-33.1
Investments (cash outflow)	-265.3	-241.7	-785.1	-1,215.8
Subsidiaries and other business units	1.9	7.4	10.8	254.3
Other fixed assets	81.0	43.3	152.2	90.1
Divestments (cash inflow)	82.8	50.8	163.0	344.5
Cash from changes in consolidation scope	0.0	-1.9	-0.4	24.2
Cash flow from investing activities - continuing operations	-182.5	-192.8	-622.5	-847.2
Cash flow from investing activities - discontinued operations	8.7		10.2	
Cash flow from investing activities	-173.8	-192.8	-612.3	-847.2
Dividend payments - HeidelbergCement AG			-317.5	-377.0
Dividend payments - non-controlling interests	-15.1	-62.0	-201.7	-176.2
Decrease in ownership interests in subsidiaries		5.9		5.9
Increase in ownership interests in subsidiaries		-7.3	-0.8	-25.5
Proceeds from bond issuance and loans	-0.8	750.0	2,255.9	1,685.4
Repayment of bonds and loans	-293.6	-10.6	-1,967.3	-1,014.7
Changes in short-term interest-bearing liabilities	-397.9	-906.9	-174.9	41.3
Cash flow from financing activities - continuing operations	-707.4	-230.7	-406.3	139.2
Cash flow from financing activities - discontinued operations				
Cash flow from financing activities	-707.4	-230.7	-406.3	139.2
Net change in cash and cash equivalents - continuing operations	-53.8	298.2	-320.8	-213.7
Net change in cash and cash equivalents - discontinued operations	8.7	-0.4	6.9	-0.8
Net change in cash and cash equivalents	-45.1	297.9	-313.9	-214.5
Effect of exchange rate changes	-47.9	-7.4	-113.9	-24.6
Cash and cash equivalents at beginning of period	1,637.5	1,579.3	1,972.3	2,108.8
Cash and cash equivalents at period end	1,544.5	1,869.7	1,544.5	1,869.7

Consolidated balance sheet

Assets	30 Sep. 2017 ¹⁾	31 Dec. 2017	30 Sep. 2018
€m			
Non-current assets			
Intangible assets			
Goodwill	11,233.9	11,106.6	11,390.1
Other intangible assets	396.7	364.5	368.8
	11,630.6	11,471.2	11,759.0
Property, plant and equipment			
Land and buildings	6,467.3	6,313.0	6,491.1
Plant and machinery	4,920.9	5,049.8	4,900.9
Other operating equipment	346.6	338.8	319.4
Prepayments and assets under construction	1,250.8	1,112.2	1,093.0
	12,985.6	12,813.8	12,804.4
Financial assets			
Investments in joint ventures	1,344.4	1,334.1	1,314.5
Investments in associates	492.5	502.4	524.7
Financial investments	332.7	256.1	255.7
Loans and derivative financial instruments	94.6	88.5	134.6
	2,264.2	2,181.1	2,229.4
Fixed assets	26,880.3	26,466.1	26,792.8
Deferred taxes	777.8	517.9	468.3
Other non-current receivables	756.1	829.0	955.8
Non-current income tax assets	51.6	52.4	58.8
Total non-current assets	28,465.8	27,865.3	28,275.8
Current assets			
Inventories			
Raw materials and consumables	860.3	823.4	907.1
Work in progress	331.6	308.7	302.4
Finished goods and goods for resale	713.5	733.3	732.8
Prepayments	25.1	15.3	17.9
	1,930.4	1,880.7	1,960.1
Receivables and other assets			
Current interest-bearing receivables	94.2	122.1	117.7
Trade receivables	2,245.3	1,797.7	2,521.2
Other current operating receivables	549.7	546.2	785.9
Current income tax assets	147.8	117.7	106.8
	3,037.1	2,583.7	3,531.7
Short-term financial investments	17.4	10.3	10.0
Derivative financial instruments	53.9	9.6	29.3
Cash and cash equivalents	1,544.5	2,108.6	1,869.7
Total current assets	6,583.4	6,593.0	7,400.9
Assets held for sale	48.5	99.7	22.0
Balance sheet total	35,097.7	34,558.0	35,698.6

¹⁾ Amounts were restated (see Annual Report 2017, section "Business combinations in the previous year", page 124 f.).

HeidelbergCement | Interim Financial Report January to September 2018

€m	30 Sep. 2017 ^a	31 Dec. 2017	30 Sep. 2018
Equity and liabilities			
Shareholders' equity and non-controlling interests			
Subscribed share capital	595.2	595.2	595.2
Share premium	6,225.4	6,225.4	6,225.4
Retained earnings	9,398.5	9,494.8	10,030.5
Other components of equity	-1,488.8	-1,757.4	-1,655.2
Equity attributable to shareholders	14,730.4	14,558.0	15,196.0
Non-controlling interests	1,520.9	1,494.3	1,325.1
Total equity	16,251.3	16,052.4	16,521.1
Non-current liabilities			
Bonds payable	8,855.4	8,345.9	9,303.8
Bank loans	477.6	459.4	629.5
Other non-current interest-bearing liabilities	52.2	57.1	48.1
Non-controlling interests with put options	21.4	18.5	20.2
	9,406.6	8,880.9	10,001.6
Pension provisions	1,150.9	1,136.8	1,083.5
Deferred taxes	707.3	649.7	656.2
Other non-current provisions	1,261.1	1,204.0	1,091.5
Other non-current operating liabilities	232.6	164.9	171.9
Non-current income tax liabilities	175.0	173.5	203.3
	3,526.8	3,328.9	3,206.5
Total non-current liabilities	12,933.4	12,209.8	13,208.0
Current liabilities			
Bonds payable (current portion)	1,301.8	1,668.4	1,144.6
Bank loans (current portion)	267.8	116.0	115.5
Other current interest-bearing liabilities	245.4	111.0	117.3
Non-controlling interests with put options	47.4	47.7	48.3
	1,862.5	1,943.1	1,425.8
Pension provisions (current portion)	94.6	82.6	81.2
Other current provisions	253.4	212.8	280.4
Trade payables	2,038.5	2,281.1	2,362.1
Other current operating liabilities	1,399.8	1,491.0	1,567.7
Current income tax liabilities	264.1	272.3	252.2
	4,050.5	4,339.8	4,543.7
Total current liabilities	5,912.9	6,282.9	5,969.4
Liabilities associated with assets held for sale		12.9	0.1
Total liabilities	18,846.4	18,505.7	19,177.6
Balance sheet total	35,097.7	34,558.0	35,698.6

Consolidated statement of changes in equity

€m	Subscribed share capital	Share premium	Retained earnings	Cash flow hedge reserve
1 January 2017²⁾	595.2	6,225.4	8,933.1	3.3
Profit for the period			768.3	
Other comprehensive income			23.3	1.1
Total comprehensive income			791.6	1.1
Changes in consolidation scope				
Changes in ownership interests in subsidiaries			-1.4	
Changes in non-controlling interests with put options			-8.1	
Transfer of asset revaluation reserve			1.0	
Other changes			-0.3	
Dividends			-317.5	
30 September 2017	595.2	6,225.4	9,398.5	4.4
1 January 2018	595.2	6,225.4	9,494.8	4.6
Adjustment IFRS 9 and IFRS 15			-12.2	
1 January 2018 adjusted	595.2	6,225.4	9,482.6	4.6
Profit for the period			914.6	
Other comprehensive income			93.6	0.9
Total comprehensive income			1,008.2	0.9
Changes in consolidation scope				
Changes in ownership interests in subsidiaries			-81.2	
Changes in non-controlling interests with put options			-2.3	
Transfer of asset revaluation reserve			0.8	
Other changes			-0.7	-0.1
Dividends			-377.0	
30 September 2018	595.2	6,225.4	10,030.5	5.5

1) The accumulated currency translation differences included in non-controlling interests changed in 2018 by € -12.5 million (previous year: -129.5) to € -299.4 million (previous year: -265.9). The total currency translation differences recognised in equity thus amounts to € -2,016.7 million (previous year: -1,818.3).

2) Amounts were restated (see Annual Report 2017, section "Business combinations in the previous year", page 124 f.).

HeidelbergCement | Interim Financial Report January to September 2018

Other components of equity

Available for sale/ FVOCI reserve	Asset revaluation reserve	Currency translation	Total other components of equity	Equity attributable to shareholders	Non-controlling interests ^u	Total equity
33.2	28.8	235.5	300.8	16,054.6	1,737.0	17,791.6
				768.3	112.2	880.4
-1.9		-1,787.9	-1,788.6	-1,765.3	-132.5	-1,897.8
-1.9		-1,787.9	-1,788.6	-997.0	-20.4	-1,017.4
				-1.4		-1.3
				-8.1	9.7	1.6
	-1.0		-1.0			
				-0.3	-3.8	-4.0
				-317.5	-201.7	-519.2
31.3	27.8	-1,552.4	-1,488.8	14,730.4	1,520.9	16,251.3
31.0	27.5	-1,820.5	-1,757.4	14,558.0	1,494.3	16,052.4
2.7			2.7	-9.4		-9.4
33.7	27.5	-1,820.5	-1,754.7	14,548.6	1,494.3	16,042.9
				914.6	101.2	1,015.8
-3.9		103.3	100.3	193.9	-33.2	160.8
-3.9		103.3	100.3	1,108.5	68.1	1,176.6
					-39.0	-39.0
				-81.2	-23.6	-104.8
				-2.3		-2.3
	-0.8		-0.8			
			-0.1	-0.7	1.2	0.5
				-377.0	-175.8	-552.8
29.8	26.7	-1,717.2	-1,655.2	15,196.0	1,325.1	16,521.1

Segment reporting / Notes

Group areas January - September	Western and Southern Europe		Northern and Eastern Europe-Central Asia		North America	
	2017	2018	2017	2018	2017	2018
€m						
External revenue	3,508	3,622	2,074	2,105	3,305	3,179
Inter-Group areas revenue	47	57	65	58		
Revenue	3,555	3,678	2,138	2,163	3,305	3,179
Change to previous year in %		3.5 %		1.2 %		-3.8 %
Result from joint ventures	2	2	12	16	30	27
Result from current operations before depreciation and amortisation (RCOBD)	459	394	403	418	802	727
as % of revenue (operating margin)	12.9 %	10.7 %	18.9 %	19.3 %	24.3 %	22.9 %
Depreciation	-233	-247	-133	-120	-223	-217
Result from current operations	227	147	270	299	579	510
as % of revenue	6.4 %	4.0 %	12.6 %	13.8 %	17.5 %	16.0 %
Result from associates	14	15	0	1	6	-2
Result from other participations	-1	3	4	0	0	-1
Result from participations	13	18	5	2	6	-4
Additional ordinary result						
Earnings before interest and taxes (EBIT)	240	165	275	300	585	506
Capital expenditures ¹⁾	153	226	76	69	187	165
Segment assets^{2,4)}	7,312	7,613	2,732	2,494	8,903	8,921
RCOBD as % of segment assets	6.3 %	5.2 %	14.8 %	16.8 %	9.0 %	8.1 %
Number of employees as at 30 September	15,588	16,010	13,774	12,727	9,755	9,748
Average number of employees	15,683	15,923	13,701	12,628	9,327	9,507

- 1) Includes corporate functions, eliminations of intra-Group relationships between the segments and additional ordinary result.
- 2) Capital expenditures = in the segment columns: property, plant and equipment as well as intangible assets investments;
in the reconciliation column: investments in non-current financial assets and other business units
- 3) Segment assets = property, plant and equipment as well as intangible assets
- 4) Prior year amounts were restated (see Annual Report 2017, section "Business combinations in the previous year", page 124 f.).

HeidelbergCement | Interim Financial Report January to September 2018

Asia-Pacific		Africa-Eastern Mediterranean Basin		Group Services		Reconciliation ⁹⁾		Continuing operations	
2017	2018	2017	2018	2017	2018	2017	2018	2017	2018
2,345	2,355	1,156	1,226	616	888			13,004	13,375
16	10	23	24	373	389	-523	-538		
2,361	2,366	1,179	1,250	990	1,277	-523	-538	13,004	13,375
	0.2%		6.0%		29.0%				2.9%
86	94	10	12					141	151
486	430	278	283	20	26	-44	-52	2,405	2,227
20.6%	18.2%	23.6%	22.7%	2.0%	2.1%			18.5%	16.6%
-144	-138	-71	-74	-3	-2	-20	-18	-827	-816
342	292	208	209	16	24	-64	-70	1,578	1,411
14.5%	12.3%	17.6%	16.8%	1.7%	1.9%			12.1%	10.5%
0	1	11	9	3	4			35	27
2	-1	0	0					5	2
2	0	11	9	3	4			40	29
						-42	94	-42	94
344	292	218	219	20	28	-106	23	1,576	1,534
106	105	52	40	0	5	210	606	785	1,216
4,093	4,007	1,522	1,480	53	48			24,616	24,563
11.9%	10.7%	18.3%	19.1%	36.7%	54.7%			9.8%	9.1%
14,220	14,263	7,044	6,388	451	454			60,830	59,589
14,373	14,280	7,236	6,514	493	437			60,812	59,288

Notes to the interim consolidated financial statements

Accounting and valuation principles

The interim consolidated financial statements of HeidelbergCement AG as at 30 September 2018 were prepared on the basis of IAS 34 (Interim Financial Reporting). All International Financial Reporting Standards (IFRS), including the interpretations of the IFRS Interpretations Committee (IFRS IC), that were binding as at the reporting date and had been adopted into European law by the European Commission were applied.

In accordance with the regulations of IAS 34, a condensed report scope in comparison with the consolidated financial statements as at 31 December 2017, with selected explanatory notes, was chosen. The accounting and valuation principles applied in the preparation of the interim consolidated financial statements correspond in principle to those of the consolidated financial statements as at 31 December 2017. Detailed explanations can be found on page 112 f. in the Notes to the 2017 Annual Report, which forms the basis for these interim financial statements.

In accordance with IAS 34, the expenses relating to income taxes in the reporting period were accrued on the basis of the tax rate expected for the whole financial year.

The interim consolidated financial statements were not subject to any audits or reviews.

Application of new accounting standards

The following new or amended IASB standards and interpretations were applicable for the first time in these interim consolidated financial statements.

- **IFRS 9 Financial Instruments** governs the accounting of financial instruments and replaces IAS 39 (Financial Instruments: Recognition and Measurement). IFRS 9 pursues a new approach for the categorisation and measurement of financial assets. In this approach, the classification and measurement of financial assets is based on the cash flow characteristics and the business model in use.

Financial assets held within a business model whose objective is to hold assets to collect the contractual cash flows are measured at amortised cost. If the business model includes the collection of contractual cash flows as well as selling financial assets, these assets are measured at fair value through other comprehensive income. If neither of the two business models applies, the financial assets are measured at fair value through profit or loss.

Participations in subsidiaries, joint ventures, and associates of minor importance, as well as participations on which HeidelbergCement has no significant influence, were classified as available for sale and measured at cost in accordance with IAS 39. In accordance with IFRS 9, the participations without significant influence have been reclassified and are measured at fair value through profit or loss. Under IAS 39, participations without controlling influence of HeidelbergCement and current financial investments were classified as available for sale and measured at fair value through other comprehensive income. In accordance with IFRS 9, these are measured at fair value through other comprehensive income or at fair value through profit or loss. Changes in the fair value recognised in other comprehensive income are recorded in the fair value through other comprehensive income reserve (FVOCI reserve). For each participation, an individual decision can be made as to whether it is measured at fair value through profit or loss or through other comprehensive income. Participations in subsidiaries, joint ventures, and associates of minor importance are still measured at cost as they are not in the scope of IFRS 9.

The majority of the loans, trade receivables, and other operating receivables continue to fulfil the criteria for accounting at amortised cost. If financial assets cannot be assigned to either of the two business models or the financial assets did not solely contain payments of principal and interest, these were reclassified and measured at fair value through profit or loss in accordance with IFRS 9.

IFRS 9 introduces a new impairment model that is applicable to all financial assets that are either measured at amortised cost or at fair value through other comprehensive income. This model provides for the recognition of expected credit losses at the time of initial recognition. This has led to an increase in risk provisions. For trade receivables, the simplified impairment approach from IFRS 9 is applied. For bank deposits, loans, and other financial receivables not classified as fair value through profit or loss, the general impairment approach of IFRS 9 is used. The effect within equity of the initial application of the new impairment model amounts to €2.2 million in trade receivables, which meant that the accumulated valuation allowances of €88.6 million as at 31 December 2017 increased to €90.8 million on 1 January 2018. In loans and other interest-bearing receivables, impairment losses of €3.2 million were recognised directly in equity as at 1 January 2018.

With regard to hedge accounting, IFRS 9 provides for the removal of the thresholds applied as part of retrospective effectiveness testing. Instead, evidence is to be documented of the economic relationship between the hedged item and the hedging instrument. Furthermore, the number of potential hedged items and the disclosures for hedge accounting were extended. The new regulations on hedge accounting will be applied prospectively. All currently existing hedges meet the requirements for hedge accounting in accordance with IFRS 9 and can be continued without amendment.

As the regulations for the classification and measurement of financial liabilities in accordance with IFRS 9 essentially correspond to the previous regulations in IAS 39, this has not resulted in any changes.

The transitional effects resulting from the initial application on 1 January 2018 led to a decrease of €11.0 million in retained earnings on 1 January 2018, not taking into account deferred taxes. As a result of the conversion to IFRS 9, the carrying amount of participations accounted for under the equity method increased on 1 January 2018. This led to an increase of €2.7 million in the FVOCI reserve.

The following table shows the reconciliation of the original measurement categories and carrying amounts of the financial assets and liabilities under IAS 39 as at 31 December 2017 with the new measurement categories and carrying amounts in accordance with IFRS 9 as at 1 January 2018.

Interim consolidated financial statements | Notes to the interim consolidated financial statements

Reconciliation IFRS 9 - classification and measurement

€m	Category of IAS 39 ¹⁾	Carrying amount IAS 39 31 Dec. 2017	Reclassification	Not in scope of IFRS 9	Measurement adjustment	Category of IFRS 9 ²⁾	Carrying amount IFRS 9 1 Jan. 2018
Assets							
Financial investments – available for sale at cost	AFS	87.1					
Non-current investments – no significant influence			36.9		-5.3	FVTPL	31.6
Non-current investments of minor importance – significant influence			50.2	-50.2			
Financial investments – available for sale at fair value	AFS	179.3					
Non-current investments – no controlling influence			169.0			FVOCI	169.0
Current financial investments			10.3			FVTPL	10.3
Loans and other interest-bearing receivables	LaR	203.5	203.5		-3.2	AC	200.3
Trade receivables and other operating receivables	LaR	2,265.4					
Trade receivables and other operating receivables – amortised cost			1,999.4	-158.2	-2.2	AC	1,839.0
Trade receivables and other operating receivables – fair value through profit or loss			266.0		-0.3	FVTPL	265.7
Cash and cash equivalents	LaR	2,108.6					
Cash and cash equivalents – amortised cost			1,902.2			AC	1,902.2
Cash and cash equivalents – fair value through profit or loss			206.4			FVTPL	206.4
Derivatives – hedge accounting	Hedge	1.7	1.7			Hedge	1.7
Derivatives – held for trading	HIT	15.0	15.0			FVTPL	15.0
		4,860.6	4,860.6	-208.4	-11.0		4,641.2
Liabilities							
Bonds payable, bank loans, and miscellaneous financial liabilities	FLAC	10,703.3	10,703.3			AC	10,703.3
Trade payables, liabilities relating to personnel, and miscellaneous operating liabilities	FLAC	3,675.3	3,675.3	-436.0		AC	3,239.3
Liabilities from finance lease	FLAC	16.6	16.6	-16.6			
Derivatives – hedge accounting	Hedge	0.0	0.0			Hedge	0.0
Derivatives – held for trading	HIT	37.8	37.8			FVTPL	37.8
Non-controlling interests with put options	FLAC	66.2	66.2			AC	66.2
		14,499.2	14,499.2	-452.6			14,046.6

1) AFS: Available for sale, LaR: Loans and receivables, Hedge: Hedge accounting, HIT: Held for trading, FLAC: Financial liabilities at amortised cost

2) AC: Amortised cost, FVTPL: Fair value through profit or loss, FVOCI: Fair value through other comprehensive income, Hedge: Hedge accounting

– IFRS 15 Revenue from Contracts with Customers replaces the regulations of IAS 18 (Revenue) and IAS 11 (Construction Contracts) as well as the associated interpretations, and was applied for the first time on 1 January 2018. For the transition to IFRS 15, the modified retrospective method was selected and the cumulative adjustment amount from the initial application was recognised directly in the retained earnings on 1 January 2018. The comparative figures for the same periods of the previous year were not adjusted. In addition, the option to simplify the initial application was exercised and IFRS 15 has been applied only to contracts that had not yet been fulfilled on 1 January 2018.

HeidelbergCement primarily generates revenue from simply structured sales of building materials, such as cement, aggregates, ready-mixed concrete, and asphalt, for which the control passes to the customer at a specific point in time.

The shift in timing of revenue recognition in individual cases due to the initial application of IFRS 15 led to a decrease of €2.7 million in retained earnings as at 1 January 2018.

Contract assets and contract liabilities are not shown separately in the balance sheet but under other operating receivables and other operating liabilities respectively. As at 1 January 2018, current contract assets of €11.7 million arose from the fulfilment of contractual obligations for which no unconditional right to payment exists as yet, and current contract liabilities of €80.0 million arose from customer prepayments. As at 30 September 2018, the current contract assets amounted to €34.4 million and the current contract liabilities to €141.9 million.

- The amendments to IFRS 2: Group Cash-settled Share-based Payment Arrangements have a narrow scope of application and concern specific areas of the classification and measurement of share-based payment transactions. The amendments did not have any impact on the financial position and performance of the Group.
- IFRIC Interpretation 22 Foreign Currency Transactions and Advance Considerations determines the timing of the exchange rate to be used for the translation of foreign currency transactions that include a prepayment made or received. The date used to determine the exchange rate for the underlying asset, income, or expense is generally the date of initial recognition of the asset or liability arising from the prepayment. The interpretation did not have any impact on the financial position and performance of the Group.

Seasonal nature of the business

The production and sales of building materials are seasonal due to regional weather patterns. Particularly in our important markets of Europe and North America, business results for the first and fourth quarters are adversely affected by the winter months, whereas the warmer months contribute to higher sales volumes and profits in the second and third quarters.

Exchange rates

The following table contains the key exchange rates used in the conversion into euro of the separate financial statements denominated in foreign currencies.

Exchange rates	Exchange rates at reporting date		Average exchange rates	
	31 Dec. 2017	30 Sep. 2018	01-09/ 2017	01-09/ 2018
EUR				
USD USA	1.2005	1.1604	1.1142	1.1943
AUD Australia	1.5372	1.6069	1.4538	1.5764
CAD Canada	1.5089	1.4979	1.4546	1.5370
EGP Egypt	21.3378	20.7483	19.9352	21.2348
GBP Great Britain	0.8881	0.8904	0.8729	0.8840
INR India	76.5327	83.9550	72.5939	80.1672
IDR Indonesia	16,264	17,324	14,873	16,874
MAD Morocco	11.2218	10.9376	10.9043	11.1587

Business combinations in the reporting period

On 2 January 2018, our subsidiary Italcementi S.p.A. completed its acquisition of a 100% shareholding in Cementir Italia and its subsidiaries. All conditions for the closing of the transaction have been fulfilled following the approval of the Italian competition authorities. To expand our market position in Italy, we made an agreement, via Italcementi, with Cementir Holding regarding the acquisition of the entire cement and concrete business line of Cementir Italia S.p.A., Rome, including the fully controlled subsidiaries Cementir Sacchi S.p.A. and Betontir S.p.A., on 19 September 2017. The purchase price amounted to €316.0 million and was paid in cash. The acquisition comprises five cement and two cement grinding plants as well as a network of terminals and ready-mixed concrete plants. The purchase price allocation has not yet been completed, as the valuations for property, plant and equipment and deferred taxes in particular have not yet been finalised. The provisionally recognised goodwill of €93.2 million is not tax-deductible and represents synergy potential.

On 31 January 2018, our Australian subsidiary Hanson Holdings Australia Limited, Victoria, (Hanson Australia) acquired 100% of the shares in Alex Fraser Pty. Ltd. Group, Victoria, one of Australia's leading manufacturers of recycled building materials and asphalt, from Swire Investments (Australia) Ltd. The purchase price amounts to €134.1 million and is subject to the usual post-closing purchase price adjustments. The company operates three production sites in Melbourne and two in Brisbane. The Alex Fraser Group also produces asphalt at two plants in Melbourne. The purchase strengthens our market positions in the urban centres of Melbourne and Brisbane. Hanson Australia is also gaining expertise in the production of asphalt and recycled building materials, which ideally complements the existing business and can be leveraged for entry into additional markets. The purchase price allocation has not yet been completed, as the valuations are still to be finalised, particularly with regard to property, plant and equipment. The provisionally recognised goodwill of €67.1 million represents synergy potential and is not tax-deductible.

Hanson Australia also acquired 100% of the shares in the Suncoast Asphalt Pty Ltd Group, Queensland, on 29 March 2018. The company produces asphalt and supplies customers in the private and public sectors in the South East Queensland region. The purchase price amounted to €18.7 million and was paid in cash. The purchase price allocation has not yet been completed, as the valuations are still to be finalised, particularly with regard to property, plant and equipment. The provisionally recognised, non-tax-deductible goodwill of €10.7 million represents synergy potential.

To strengthen its market position in Canada, HeidelbergCement acquired a cement plant in the province of Quebec on 7 February 2018 as part of an asset deal. The purchase price of €43.1 million, paid in cash, is subject to a standard working capital adjustment clause. The purchase price allocation has not yet been completed, as the valuations are still to be finalised, particularly with regard to property, plant and equipment. The provisionally recognised, tax-deductible goodwill of €38.4 million represents synergy potential.

In addition, HeidelbergCement acquired 100% of the shares in both Fairburn Ready-Mix, Inc., Tyrone, and Harrell Aggregate Hauling, Inc., Tyrone, on 6 April 2018 via its US subsidiary Sherman Industries LLC, Wilmington. Fairburn Ready-Mix operates five ready-mixed concrete plants in the Atlanta metropolitan area. This acquisition complements HeidelbergCement's core business and provides a platform for further growth. The purchase price totalling €18.0 million, paid in cash, is subject to the usual post-closing purchase price adjustments. The purchase price allocation has not yet been completed, as the valuations are still to be finalised, particularly with regard to property, plant and equipment. The provisionally recognised, tax-deductible goodwill of €11.9 million represents synergy and growth potential.

On 31 August 2018, HeidelbergCement acquired the business operations of three aggregate quarries in Belgium as part of an asset deal. The purchase price amounted to €28.8 million and is subject to the usual post-closing adjustments. The purchase price allocation has not yet been completed, as the measurements are still to be finalised.

The following table shows the provisional fair values of the assets and liabilities acquired as part of the transactions described above.

Provisional fair values recognised as at the acquisition date

€m	Italy	Australia	North America	Belgium	Total
Intangible assets	12.3	10.2	6.6		29.1
Property, plant and equipment	166.5	52.5	6.8	28.8	254.6
Financial fixed assets	0.2				0.2
Deferred taxes	14.7	0.3			15.0
Inventories	31.2	1.9	5.1		38.3
Trade receivables	51.2	19.2	1.7		72.1
Cash and cash equivalents	25.9	6.4	0.4		32.8
Other assets	17.3	0.7	0.1		18.1
Assets held for sale	47.8				47.8
Total assets	367.1	91.3	20.8	28.8	508.0
Deferred taxes	0.5				0.5
Provisions	45.9	3.3	6.6		55.8
Non-current liabilities	0.0	13.0	1.2		14.2
Current liabilities	96.0	0.0	2.0		98.0
Liabilities associated with assets held for sale	2.0				2.0
Total liabilities	144.3	16.3	9.9		170.5
Net assets	222.8	75.1	10.9	28.8	337.5

As part of the business combinations, receivables with a fair value of €77.4 million were acquired. These concern trade receivables amounting to €72.1 million and other operating receivables to the amount of €5.1 million. The gross value of the contractual receivables totals €112.4 million, of which €35.0 million is likely to be irrecoverable.

The business combinations in Italy, Australia, Canada, and the USA have contributed €147.2 million to revenue and €-16.6 million to the profit for the period since their acquisition. If the acquisitions had taken place on 1 January 2018, contributions to revenue and the profit for the period would be €15.0 million higher and €1.0 million higher, respectively.

The transaction costs of €4.5 million for the business combinations were recognised in the additional ordinary expenses.

Furthermore, HeidelbergCement effected other business combinations during the reporting period that are of minor importance for the presentation of the financial position and performance of the Group.

Business combinations in the same period of the previous year

On 30 June 2017, HeidelbergCement finalised the acquisition of aggregate pits and production sites for ready-mixed concrete and asphalt from Cemex in the northwest of the USA. The business activities taken over from Cemex include seven aggregate quarries, five ready-mixed concrete plants, and three asphalt plants. The aggregates reserves and resources that have been acquired amount to 110 million tonnes. With this acquisition, HeidelbergCement has strengthened its vertically integrated market position in the US states of Washington and Oregon. The purchase price of €129.8 million was settled in cash. The purchase price allocation has been completed. This resulted in a decrease of €1.1 million in property, plant and equipment and a rise of €0.3 million in provisions in comparison with 31 December 2017. The final goodwill of €38.0 million is tax-deductible and represents synergy potential.

To strengthen its market position in aggregates and ready-mixed concrete in the US state of New York, HeidelbergCement concluded the purchase of the operating assets and liabilities of the Saunders Companies on 1 August 2017. The final purchase price after adjustment amounted to €30.9 million and was settled in cash. The purchase price allocation has been completed. The tax-deductible goodwill following the purchase price adjustment amounts to €5.3 million and represents synergy potential.

The following table shows the final fair values of the assets and liabilities as at the acquisition date.

Fair values recognised as at the acquisition date

€m	North America
Intangible assets	3.2
Property, plant and equipment	121.6
Inventories	9.6
Trade receivables	3.2
Other assets	3.4
Total assets	141.0
Provisions	21.3
Current liabilities	2.2
Total liabilities	23.6
Net assets	117.4

Divestments in the reporting period

On 15 December 2017, HeidelbergCement announced that it had signed an agreement with H+H International A/S and its subsidiary H+H Deutschland GmbH regarding the sale of the sand-lime brick activities. The sale was completed on 28 February 2018 and comprises the participations in the indirect subsidiaries Heidelberger Kalksandstein GmbH, KS-QUADRO Bausysteme GmbH, Durmersheim, Germany, and Hunziker Kalksandstein AG, Brugg, Switzerland. Additionally, it includes property belonging to subsidiaries of HeidelbergCement AG. As at 31 December 2017, the divested assets and liabilities were shown as disposal groups in the consolidated balance sheet. The sales price of €109.4 million was paid in cash. The divestment resulted in a gain of €69.2 million, which has been shown in the additional ordinary income.

On 14 February 2018, our US subsidiary Lehigh Cement Company LLC, Wilmington, signed an agreement for the sale of its 51% participation in Lehigh White Cement Company, Harrisburg, to the non-controlling shareholders Aalborg Cement Company Inc. and Cemex, Inc. The sale was completed on 29 March 2018. The sales price amounted to €115.1 million and was paid in cash. It is subject to the usual post-closing purchase price adjustments. The profit on disposal of €46.3 million was recognised in the additional ordinary income.

On 1 June 2018, our Italian subsidiary Italcementi S.p.A. completed the sale of the cement plant in Maddaloni, Italy, via its subsidiary Cementir Italia S.p.A. With the disposal, HeidelbergCement met a condition imposed by the Italian competition authorities in connection with the acquisition of the Cementir activities in Italy. At the time of Cementir's acquisition, the divested assets and liabilities were shown as disposal groups. The disposal price is made up of a cash payment of €10.0 million and a discounted purchase price receivable of €33.2 million, which includes an estimated price adjustment.

On 6 August 2018, HeidelbergCement completed the disposal of its shares in Suez Bags Company S.A.E., Cairo, Egypt. The sales price amounted to €7.7 million and was paid in cash. The divestment resulted in a gain of €4.3 million, which has been recorded in the additional ordinary income.

The following table shows the assets and liabilities as at the date of divestiture.

Assets and liabilities at date of divestiture

€m	Sand-lime brick activities	North America	Italy	Egypt	Total
Intangible assets		33.6			33.6
Property, plant and equipment		27.4		1.3	28.6
Inventories		28.9		3.5	32.4
Cash and cash equivalents		2.9		2.9	5.8
Other assets		19.7		3.4	23.2
Disposal groups held for sale	51.5		45.1		96.6
Total assets	51.5	112.5	45.1	11.1	220.2
Provisions		0.7		0.2	0.8
Liabilities		11.7		3.8	15.5
Liabilities associated with disposal groups	11.3		1.9		13.2
Total liabilities	11.3	12.3	1.9	4.0	29.5
Net assets	40.2	100.2	43.2	7.1	190.7

Incidental disposal costs of €5.4 million arose in connection with the divestments and were recognised in the additional ordinary expenses.

Furthermore, HeidelbergCement effected other divestments during the reporting period that are of minor importance for the presentation of the financial position and performance of the Group.

Divestments in the same period of the previous year

On 8 February 2017, HeidelbergCement sold 100% of the shares in Essroc San Juan Inc., Puerto Rico. The company was acquired as part of the Italcementi acquisition. The sales price for Essroc San Juan amounted to €6.5 million and was paid in cash. The divestment resulted in a loss of €6.0 million, which was recognised in the additional ordinary expenses.

The following table shows the assets and liabilities as at the date of divestiture.

Assets and liabilities at date of divestiture

€m	North America
Property, plant and equipment	4.8
Inventories	7.8
Cash and cash equivalents	1.0
Other assets	1.4
Total assets	15.0
Liabilities	2.5
Total liabilities	2.5
Net assets	12.5

HeidelbergCement | Interim Financial Report January to September 2018

Revenue development by Group areas and business lines

January - September	Cement		Aggregates		Ready-mixed concrete-asphalt		Service-joint ventures-others		Intra-Group eliminations		Total	
	2017	2018	2017	2018	2017	2018	2017	2018	2017	2018	2017	2018
€m												
Western and Southern Europe	1,774	1,890	759	795	1,339	1,365	307	426	-624	-798	3,555	3,678
Northern and Eastern Europe-Central Asia	1,196	1,177	380	397	433	461	290	297	-160	-168	2,138	2,163
North America	1,423	1,301	1,208	1,197	793	811	196	201	-315	-331	3,305	3,179
Asia-Pacific	1,301	1,257	469	447	814	847	28	56	-251	-242	2,361	2,366
Africa-Eastern Mediterranean Basin	909	972	83	71	241	248	21	32	-75	-72	1,179	1,250
Group Services					29	29	970	1,257	-9	-9	990	1,277
Inter-Group area revenue within business lines	-44	-43	-21	-23			0	5			-65	-61
Total	6,558	6,553	2,878	2,885	3,649	3,760	1,812	2,275	-1,435	-1,620	13,462	13,852
Inter-Group area revenue between business lines									-458	-477	-458	-477
Total									-1,894	-2,098	13,004	13,375

Earnings per share

Earnings per share	January - September	
	2017	2018
€m		
Profit for the period	880.4	1,015.8
Non-controlling interests	112.2	101.2
Group share of profit	768.3	914.6
Number of shares in '000s (weighted average)	198,416	198,416
Earnings per share in €	3.87	4.61
Net income from continuing operations – attributable to the parent entity	779.0	926.3
Earnings per share in € – continuing operations	3.93	4.67
Net loss from discontinued operations – attributable to the parent entity	-10.7	-11.7
Loss per share in € – discontinued operations	-0.06	-0.06

Goodwill

An impairment test on goodwill in accordance with IAS 36 (Impairment of Assets) is generally performed annually within the HeidelbergCement Group, in the fourth quarter once the operational three-year plan has been prepared or if there are indications for impairment. In this impairment test, the carrying amount of a group of cash-generating units (CGUs) to which goodwill is allocated is compared with the recoverable amount of this group of CGUs. On 30 September 2018, the management carried out an impairment review, which indicated that no impairment loss needed to be recognised.

Consolidated statement of changes in equity

The decrease in non-controlling interests due to changes in the consolidation scope primarily relates to the disposal of the US subsidiary Lehigh White Cement Company. Changes in ownership interests in subsidiaries result primarily from the acquisition of the remaining 40% of the shares in Nordic Precast Group AB, Stockholm, Sweden.

In the financial year, dividends of €377.0 million (€1.90 per share) were paid to shareholders of HeidelbergCement AG. Dividend payments to non-controlling interests are primarily the result of dividend payments made by our Indonesian subsidiary PT Indocement Tunggal Prakasa Tbk., amounting to €75.3 million, as well as dividends from our Moroccan subsidiaries Ciments du Maroc S.A. and Industrie Sakia El Hamra "Indusaha" S.A., which totalled €51.6 million.

Pension provisions

The actuarial gains and losses, which are recognised directly in equity in other comprehensive income, were determined on the basis of the interest rates for the key countries applicable as at the reporting date. As at 30 September 2018, the overall gains arising from the revaluation amounted to €133.0 million. These include actuarial gains relating to pension obligations of €310.8 million, arising from the increase in the weighted discount rate of approximately 0.5 percentage points, as well as

Interim consolidated financial statements | Notes to the interim consolidated financial statements

losses from the revaluation of the plan assets amounting to €154.8 million. The effect of the asset ceiling led to losses of €16.3 million.

Disclosures on financial instruments

The following table shows the carrying amounts and fair values for the individual classes of financial instruments as well as the fair value hierarchy for the assets and liabilities that are measured at fair value in the balance sheet.

Carrying amounts and fair values of financial instruments

€m	Carrying amount	Fair value	Thereof Level 1	Thereof Level 2	Thereof Level 3
30 September 2018 (IFRS 9)					
Assets					
Financial investments – fair value through other comprehensive income	173.9	173.9			173.9
Financial investments – fair value through profit or loss	41.1	41.1	10.0		31.1
Loans and other interest-bearing receivables	206.9	210.7			
Trade receivables and other operating receivables - amortised cost	2,638.6	2,638.6			
Trade receivables and other operating receivables - fair value through profit or loss	316.6	316.6		316.6	
Cash and cash equivalents – amortised cost	1,684.8	1,684.8			
Cash and cash equivalents – fair value through profit or loss	184.9	184.9	184.9		
Derivatives – hedge accounting	6.0	6.0		6.0	
Derivatives – held for trading	68.8	68.8		68.8	
Liabilities					
Bonds payable, bank loans, and miscellaneous financial liabilities	11,303.7	11,675.7			
Trade payables and miscellaneous operating liabilities	3,275.5	3,275.5			
Derivatives – hedge accounting	3.2	3.2		3.2	
Derivatives – held for trading	38.6	38.6		38.6	
Non-controlling interests with put options	68.5	68.5			
31 December 2017 (IAS 39)					
Assets					
Financial investments – available for sale at cost	87.1				
Financial investments – available for sale at fair value	179.3	179.3	10.3		169.0
Loans and other interest-bearing receivables	203.5	208.6			
Trade receivables and other operating receivables	2,265.4	2,265.4			
Cash and cash equivalents	2,108.6	2,108.6			
Derivatives – hedge accounting	1.7	1.7		1.7	
Derivatives – held for trading	15.0	15.0		15.0	
Liabilities					
Bonds payable, bank loans, and miscellaneous financial liabilities	10,703.4	11,324.6			
Trade payables, liabilities relating to personnel, and miscellaneous operating liabilities	3,675.3	3,675.3			
Liabilities from finance lease	16.6	16.6			
Derivatives – hedge accounting	0.0	0.0		0.0	
Derivatives – held for trading	37.8	37.8		37.8	
Non-controlling interests with put options	66.2	66.2			

The financial investments “Fair value through other comprehensive income” include the fair values of the US participations Hanson Permanente Cement, Inc. and Kaiser Gypsum Company, Inc. The change in the fair values of the participations resulted from exchange rate effects. The other valuation parameters remained unchanged. With respect to possible uncertainties regarding the determination of the fair value of this financial investment, we refer to the explanations on page 130 in the Notes to the 2017 Annual Report. During the reporting period, there were no significant changes to the explanations in the Notes.

The financial investments "Fair value through profit or loss" include participations of €31.1 million on which HeidelbergCement has no significant influence. These investments were primarily measured using the multiplier method, which determines the proportionate enterprise value based on company-specific variables and multipliers. Furthermore, financial investments amounting to €10.0 million for which the fair value was determined using the stock market price at the reporting date are recognised here. These financial investments were deposited as security for existing and future reinsurance services.

Cash and cash equivalents "Fair value through profit or loss" include highly liquid investment funds whose fair value was determined using the stock market price at the reporting date.

The "Trade receivables and other operating receivables" and "Trade payables and miscellaneous operating liabilities" classes cannot be immediately reconciled with the related balance sheet items, as these contain not only financial assets and liabilities but also non-financial assets to the amount of €1,307.6 million as well as non-financial liabilities of €839.6 million.

Detailed explanations on the procedure regarding the fair value measurement according to IFRS 13 can be found on page 166 f. in the Notes to the 2017 Annual Report, which forms the basis for these interim financial statements.

The assessment as to whether financial assets and liabilities that are accounted for at fair value are to be transferred between the levels of the fair value hierarchy will take place at the end of each reporting period. No reclassifications were carried out in the reporting period.

Related parties disclosures

No reportable transactions with related parties took place in the reporting period beyond normal business relations.

Contingent liabilities

As at the reporting date, contingent liabilities amounted to €70.3 million (previous year: 71.2), which essentially concern legal and tax-related risks. The timing of the possible cash outflows for the contingent liabilities is uncertain because they depend on various external factors that remain outside HeidelbergCement's control. The application of taxation regulations might not yet be determined at the time that tax refund claims and liabilities are calculated. The calculation of tax items is based on the regulations most likely to be applied in each case. Nevertheless, the fiscal authorities may be of a different opinion, which may give rise to additional tax liabilities.

Other financial commitments

The total future minimum lease payments for operating leases as at the reporting date are shown in the following table.

Other financial commitments

€m	31 Dec. 2017	30 Sep. 2018
Future minimum lease payments under non-cancellable operating leases		
Due within one year	265.5	285.2
Due between one and five years	602.8	664.5
Due after five years	464.5	648.0
	1,332.8	1,597.7

Events after the reporting period

There were no reportable events after the reporting date.

Heidelberg, 8 November 2018

HeidelbergCement AG
The Managing Board

The Company has its registered office in Heidelberg, Germany.
It is registered with the Commercial Register at the Local Court
of Mannheim (Amtsgericht Mannheim) under HRB 330082.

Contact:

Group Communication

Phone: +49 (0) 6221 481-13 227

Fax: +49 (0) 6221 481-13 217

E-mail: info@heidelbergcement.com

Investor Relations

Phone:

Institutional investors USA and UK: +49 (0) 6221 481-13 925

Institutional investors EU and rest of the world: +49 (0) 6221 481-39568

Private investors: +49 (0) 6221 481-13 256

Fax: +49 (0) 6221 481-13 217

E-mail: ir-info@heidelbergcement.com

The Interim Financial Report January to September 2018 was published on 8 November 2018.

Financial calendar

Consolidated financial statements 2018	21 March 2019
Press conference on annual accounts	21 March 2019
Interim Financial Report January to March 2019	9 May 2019
Annual General Meeting 2019	9 May 2019
Half-Year Financial Report January to June 2019	30 July 2019
Interim Financial Report January to September 2019	7 November 2019

Section L

Lehigh Hanson
HEIDELBERGCEMENT Group

Lehigh Hanson
300 E. John Carpenter Freeway
Irving, TX 75062

972-653-5500
www.LehighHanson.com

CREDIT INFORMATION

Company Name: Lehigh Hanson, Inc. (including U.S. subsidiaries and affiliates)

Parent Company: HeidelbergCement AG

Tax ID Number: 59-2503701

Business: Cement, Aggregates

President: Jon Morrish

CFO: Henner Böttcher

Corporate Address: 300 E. John Carpenter Freeway, Irving TX 75062

References:

F.L. Smidth
2040 Avenue C
Bethlehem, PA 18017-2188
Email: Rachel.Schnecker@flsmidth.com

Brandeis Equipment
Attn: Gwen Meyer
1801 Watterson Trail P.O. Box 32230
Louisville, KY 40232-2230
Office: (502) 493-4300
Fax: (502) 499-3190

BASF Corporation
Attn: Constantine Marinis
(Senior Credit Analyst, CCE, CICP)
23700 Chagrin Blvd.
Beachwood, Ohio 44122
Phone: +1 216 839 7091
Mobile: +1 862-308-3669
Fax: +1 216-839-8817
E-Mail: constantine.marinis@basf.com

GCP Applied Technologies Inc.
Attn: Accounts Receivable Dept.
62 Whittemore Avenue
Cambridge, MA 02140
Phone: 877.423.6491
Fax: 617-498-4323 or 617-812-1270
Email: GPC-CustCredit.Administration@gcpat.com
Website: GCPat.com

Bank Name: Bank of America
Bank Account: 4426638159

For bank credit information inquiries, please sign up for an account via www.bankVOD.com and choose either same-day service for \$25.00 (request must be received prior to 3 p.m. EST) or 3-day service for \$10.00. Information provided includes open date, type of account, and average collected balance. Mail and/or fax requests are no longer accepted.

Section M

Fidelity and Deposit Company of Maryland Bond No. 08800188 replaces and supercedes General Insurance Company of America Bond No. 6291711/VM6040556 effective June 20, 2011.

INDEMNITY AND PAYMENT BOND

BOND NO. 08800188

KNOW ALL BY THESE PRESENTS:

That we, Continental Florida Materials, Inc. as INDEMNITOR and Fidelity and Deposit Company of Maryland as SURETY, a surety company authorized to do business in the State of Florida, are held and firmly bound unto BROWARD COUNTY, as OBLIGEE, a political subdivision of the State of Florida, in the full sum of Fifty Thousand and no/100-- DOLLARS (\$50,000.00--), for the payment of which we bind ourselves, our heirs, successors, assigns and personal representatives for the performance of the obligations hereinafter set forth:

NOW THEREFORE, the condition of this obligation is such that if INDEMNITOR, its heirs, executors, administrators, successors and assigns shall well and truly save harmless and keep indemnified BROWARD COUNTY, its successors and assigns, from and against all loss, costs, expenses, damages, injury, claims, actions, liabilities and demands of every kind (including but not limited to all reasonable attorney's fees to and through appellate, supplemental and bankruptcy proceedings) which arises from, is caused by, or results from or on account of:

- (i) failure of INDEMNITOR to pay to BROWARD COUNTY, when due, any and all tariff or other charges that have accrued at Port Everglades (whether relating to the furnishing of services or materials to INDEMNITOR, its principals, agents, servants or employees at Port Everglades; or, due to injury to property of Port Everglades; or, stemming from the use of Port Everglades facilities by INDEMNITOR, its principals, agents, servants or employees; or, otherwise); or
- (ii) non-compliance by INDEMNITOR, its principals, agents, servants or employees with applicable laws, ordinances, rules and regulations of the federal, state and local governmental units or agencies (including but not limited to the terms and provisions of the BROWARD COUNTY Code of Ordinances, Administrative Code, and all procedures and policies of the Port Everglades Department), as amended from time to time; or
- (iii) any act, omission, negligence or misconduct of INDEMNITOR, its principals, agents, servants or employees in Port Everglades (whether causing injury to persons or otherwise;

then these obligations shall be null and void, otherwise to remain in full force and effect.

AS A FURTHER CONDITION of this obligation that it shall remain in full force and effect until and unless the Surety provides at least ninety (90) days prior written notice to BROWARD COUNTY of its intention to terminate this Bond.

Any notices required herein shall be given in writing and be delivered to: Broward County's Port Everglades Department, Attn: Director of Administration, 1850 Eller Drive, Fort Lauderdale, Florida 33316, with a copy to: Broward County Administrator, Governmental Center, 115 S. Andrews Avenue, Fort Lauderdale, Florida 33301.

IN WITNESS WHEREOF, INDEMNITOR has caused this Bond to be executed by _____, and attested to by its Secretary and its corporate seal to be affixed, and the Surety has caused this Bond to be executed in its name by its Attorney-in-Fact duly authorized to do so.

INDEMNITOR:

Company Name: Continental Florida Materials, Inc.

ATTEST:

Corporate Secretary

(Print Name of Secretary)

(SEAL)

By: _____

(Print Name of Pres./Vice Pres.)

Title: _____
(Print)

_____ day of _____, 20____

SURETY:

Company Name: _____

ATTEST:

Claudia Nuñez
Claudia Nuñez, Witness

(SEAL)

By: Bridgette S. Jackson

Bridgette S. Jackson
(Print Name of Pres./Vice Pres.)

Title: Attorney-in-Fact
(Print)

_____ 20th day of June _____, 20 11

**ZURICH AMERICAN INSURANCE COMPANY
COLONIAL AMERICAN CASUALTY AND SURETY COMPANY
FIDELITY AND DEPOSIT COMPANY OF MARYLAND
POWER OF ATTORNEY**

KNOW ALL MEN BY THESE PRESENTS: That the ZURICH AMERICAN INSURANCE COMPANY, a corporation of the State of New York, the COLONIAL AMERICAN CASUALTY AND SURETY COMPANY, a corporation of the State of Maryland, and the FIDELITY AND DEPOSIT COMPANY OF MARYLAND a corporation of the State of Maryland (herein collectively called the "Companies"), by THOMAS O. MCCLELLAN, Vice President, in pursuance of authority granted by Article V, Section 8, of the By-Laws of said Companies, which are set forth on the reverse side hereof and are hereby certified to be in full force and effect on the date hereof, do hereby nominate, constitute, and appoint Phil NEIGHORN, Bridgette S. JACKSON and Claudia NUNEZ, all of Dallas, Texas, EACH its true and lawful agent and Attorney-in-Fact, to make, execute, seal and deliver, for, and on its behalf as surety, and as its act and deed; any and all bonds and undertakings, EXCEPT bonds on behalf of Independent Executors, Community Survivors and Community Guardians, and the execution of such bonds or undertakings in pursuance of these presents, shall be as binding upon said Companies, as fully and amply, to all intents and purposes, as if they had been duly executed and acknowledged by the regularly elected officers of the ZURICH AMERICAN INSURANCE COMPANY at its office in New York, New York., the regularly elected officers of the COLONIAL AMERICAN CASUALTY AND SURETY COMPANY at its office in Owings Mills, Maryland., and the regularly elected officers of the FIDELITY AND DEPOSIT COMPANY OF MARYLAND at its office in Owings Mills, Maryland., in their own proper persons.

The said Vice President does hereby certify that the extract set forth on the reverse side hereof is a true copy of Article V, Section 8, of the By-Laws of said Companies, and is now in force.

IN WITNESS WHEREOF, the said Vice-President has hereunto subscribed his/her names and affixed the Corporate Seals of the said ZURICH AMERICAN INSURANCE COMPANY, COLONIAL AMERICAN CASUALTY AND SURETY COMPANY, and FIDELITY AND DEPOSIT COMPANY OF MARYLAND, this 14th day of May, A.D. 2012.

ATTEST:

**ZURICH AMERICAN INSURANCE COMPANY
COLONIAL AMERICAN CASUALTY AND SURETY COMPANY
FIDELITY AND DEPOSIT COMPANY OF MARYLAND**



By: Eric D. Barnes
Assistant Secretary
Eric D. Barnes

Thomas O. McClellan
Vice President
Thomas O. McClellan

State of Maryland
City of Baltimore

On this 14th day of May, A.D. 2012, before the subscriber, a Notary Public of the State of Maryland, duly commissioned and qualified, THOMAS O. MCCLELLAN, Vice President, and ERIC D. BARNES, Assistant Secretary, of the Companies, to me personally known to be the individuals and officers described in and who executed the preceding instrument, and acknowledged the execution of same, and being by me duly sworn, deposeth and saith, that he/she is the said officer of the Company aforesaid, and that the seals affixed to the preceding instrument are the Corporate Seals of said Companies, and that the said Corporate Seals and the signature as such officer were duly affixed and subscribed to the said instrument by the authority and direction of the said Corporations.

IN TESTIMONY WHEREOF, I have hereunto set my hand and affixed my Official Seal the day and year first above written.

Constance A. Dunn



Constance A. Dunn, Notary Public
My Commission Expires: July 14, 2015

EXTRACT FROM BY-LAWS OF THE COMPANIES

"Article V, Section 8. Attorneys-in-Fact. The Chief Executive Officer, the President, or any Executive Vice President or Vice President may, by written instrument under the attested corporate seal, appoint attorneys-in-fact with authority to execute bonds, policies, recognizances, stipulations, undertakings, or other like instruments on behalf of the Company, and may authorize any officer or any such attorney-in-fact to affix the corporate seal thereto; and may with or without cause modify or revoke any such appointment or authority at any time."

CERTIFICATE

I, the undersigned, Vice President of the ZURICH AMERICAN INSURANCE COMPANY, the COLONIAL AMERICAN CASUALTY AND SURETY COMPANY, and the FIDELITY AND DEPOSIT COMPANY OF MARYLAND, do hereby certify that the foregoing Power of Attorney is still in full force and effect on the date of this certificate; and I do further certify that Article V, Section 8, of the By-Laws of the Companies is still in force.

This Power of Attorney and Certificate may be signed by facsimile under and by authority of the following resolution of the Board of Directors of the ZURICH AMERICAN INSURANCE COMPANY at a meeting duly called and held on the 15th day of December 1998.

RESOLVED: "That the signature of the President or a Vice President and the attesting signature of a Secretary or an Assistant Secretary and the Seal of the Company may be affixed by facsimile on any Power of Attorney...Any such Power or any certificate thereof bearing such facsimile signature and seal shall be valid and binding on the Company."

This Power of Attorney and Certificate may be signed by facsimile under and by authority of the following resolution of the Board of Directors of the COLONIAL AMERICAN CASUALTY AND SURETY COMPANY at a meeting duly called and held on the 5th day of May, 1994, and the following resolution of the Board of Directors of the FIDELITY AND DEPOSIT COMPANY OF MARYLAND at a meeting duly called and held on the 10th day of May, 1990.

RESOLVED: "That the facsimile or mechanically reproduced seal of the company and facsimile or mechanically reproduced signature of any Vice-President, Secretary, or Assistant Secretary of the Company, whether made heretofore or hereafter, wherever appearing upon a certified copy of any power of attorney issued by the Company, shall be valid and binding upon the Company with the same force and effect as though manually affixed.

IN TESTIMONY WHEREOF, I have hereunto subscribed my name and affixed the corporate seals of the said Companies, this 20th day of June, 2011.



Geoffrey Delisio

Geoffrey Delisio, Vice President

Section N

Equipment	Manufacturer	Model	Age (yrs)	Power	Location
Ship unloader	Siwertell		34	Electric	Port Everglades
Hor/Vert screw conveyors	Nordströms		34	Electric	Port Everglades
Front-End loader	Volvo	L-70	16	Diesel	Port Everglades
Front-End loader	Volvo	L-90	14	Diesel	Port Everglades
Forklift	Toyota	4000	4	Diesel	Port Everglades
Manlift	JLG	800S	11	Diesel	Port Everglades
Skid Steer	John Deere	312	12	Diesel	Port Everglades
Sweeper	Tennant	800	15	Diesel	Port Everglades
Beltline dust collector 1	MES	12000 CFM	1	Diesel	Port Everglades
Beltline dust collector 2	MES	12000 CFM	0.5	Diesel	Port Everglades
Emergency generator	Cummings	300 KW	21	Diesel	Port Everglades
Portable compressor	Sullair	900 CFM	5	Diesel	Port Everglades
Paint compressed air system	Sullivan	SP-16	1	Electric	Port Everglades
Silos transfer system	Fuller/FLS	250M / C225	14	Electric	Port Everglades

Section 0

BROWARD COUNTY LOCAL BUSINESS TAX RECEIPT

115 S. Andrews Ave., Rm. A-100, Ft. Lauderdale, FL 33301-1895 – 954-831-4000

VALID OCTOBER 1, 2018 THROUGH SEPTEMBER 30, 2019

DBA: CONTINENTAL FLORIDA MATERIALS INC
Business Name:

Receipt #: 378-4569
Business Type: WHOLESALE/DISTRIBUTOR
(WHOLESALE/DISTRIBUTOR)

Owner Name: CONTINENTAL FLORIDA MATERIALS INC
Business Location: 2600 EISENHOWER BLVD
FT LAUDERDALE
Business Phone: 954-523-6416

Business Opened: 09/22/1999
State/County/Cert/Reg:
Exemption Code:

Rooms Seats Employees Machines Professionals

For Vending Business Only						
Number of Machines:				Vending Type:		
Tax Amount	Transfer Fee	NSF Fee	Penalty	Prior Years	Collection Cost	Total Paid
45.00	0.00	0.00	0.00	0.00	0.00	45.00

THIS RECEIPT MUST BE POSTED CONSPICUOUSLY IN YOUR PLACE OF BUSINESS

**THIS BECOMES A TAX RECEIPT
WHEN VALIDATED**

This tax is levied for the privilege of doing business within Broward County and is non-regulatory in nature. You must meet all County and/or Municipality planning and zoning requirements. This Business Tax Receipt must be transferred when the business is sold, business name has changed or you have moved the business location. This receipt does not indicate that the business is legal or that it is in compliance with State or local laws and regulations.

Mailing Address:

CONTINENTAL FLORIDA MATERIALS INC
PO BOX 13128
FORT LAUDERDALE, FL 33316

Receipt # WWW-17-00162069
Paid 07/30/2018 45.00

2018 - 2019

BROWARD COUNTY LOCAL BUSINESS TAX RECEIPT

115 S. Andrews Ave., Rm. A-100, Ft. Lauderdale, FL 33301-1895 – 954-831-4000

VALID OCTOBER 1, 2018 THROUGH SEPTEMBER 30, 2019

DBA: CONTINENTAL FLORIDA MATERIALS INC
Business Name:

Receipt #: 378-4569
Business Type: WHOLESALE/DISTRIBUTOR
(WHOLESALE/DISTRIBUTOR)

Owner Name: CONTINENTAL FLORIDA MATERIALS INC
Business Location: 2600 EISENHOWER BLVD
FT LAUDERDALE
Business Phone: 954-523-6416

Business Opened: 09/22/1999
State/County/Cert/Reg:
Exemption Code:

Rooms Seats Employees Machines Professionals

For Vending Business Only							
Number of Machines:				Vending Type:			
Signature	Tax Amount	Transfer Fee	NSF Fee	Penalty	Prior Years	Collection Cost	Total Paid
	45.00	0.00	0.00	0.00	0.00	0.00	45.00

Receipt # WWW-17-00162069
Paid 07/30/2018 45.00

Section P

BLOODBORNE PATHOGENS (OSHA Operations)

CORPORATE POLICY, REQUIREMENTS AND PROCEDURES

1.1. Purpose – To establish requirements and procedures to eliminate or control employees' occupational exposure to blood and certain other potentially infectious body fluids.

1.2. Definitions

- A. **Blood** – Human blood, human blood components, and products made from human blood.
- B. **Bloodborne Pathogens** – Pathogenic microorganisms that are present in human blood and can cause disease in humans. These pathogens include, but are not limited to, hepatitis B virus (HBV) and human immunodeficiency virus (HIV).
- C. **Exposure Incident** – A specific eye, mouth, other mucous membrane, non-intact skin, or parenteral contact with blood or other potentially infectious materials that results from the performance of an employee's duties.
- D. **Occupational Exposure** – Reasonably anticipated skin, eye, mucous membrane, or parenteral contact with blood or other potentially infectious materials that may result from the performance of an employee's duties.
- E. **Other Potentially Infectious Materials (OPIM)** – Any of the following human body fluids: semen, vaginal secretions, cerebrospinal fluid, synovial fluid, pleural fluid, pericardial fluid, peritoneal fluid, amniotic fluid, saliva in dental procedures, any body fluid that is visibly contaminated with blood, and all body fluids in situations where it is difficult or impossible to differentiate between body fluids and any unfixed tissue or organ (other than intact skin) from a human (living or dead).
- F. **Parenteral** – Piercing mucous membranes or the skin barrier through such events as needle sticks, human bites, cuts and abrasions.
- G. **Regulated Waste** – Liquid or semi-liquid blood or OPIM; contaminated items that would release blood or OPIM in a liquid or semi-liquid state if compressed; items that are caked with dried blood or OPIM and are capable of releasing these materials during handling; contaminated sharps; and pathological and microbiological wastes containing blood or OPIM.
- H. **Source Individual** – Any individual, living or dead, whose blood or OPIM may be a source of occupational exposure to an employee.
- I. **Universal Precautions** – An approach to infection control. According to the concept of Universal Precautions, all human blood and certain human body fluids are treated as if known to be infectious for HIV, HBV and other bloodborne pathogens.
- J. **Work Practice Controls** – Controls that reduce the likelihood of exposure by altering the manner in which a task is performed; such as the use of latex gloves when controlling bleeding.

BLOODBORNE PATHOGENS (OSHA Operations)

1.3. Employee Exposure Determination

- A. In the event of an accident or personal injury occurring on company property, those employees designated as first aid providers in the site-specific Emergency Action Plan, shall respond to the scene of the incident with first aid/trauma kits and render first aid if the victim can be reached safely. Employees designated as first aid providers could have occupational exposure to blood or OPIM as a result of their first aid/CPR duties, and therefore, will receive training pertaining to the potential hazards and precautions associated with exposure to blood or OPIM.
- B. Training pertaining to the potential hazards and precautions associated with exposure to blood or OPIM shall be included as part of the general first aid training that all employees receive.

1.4. Exposure Control Plan

A. Universal Precautions

- Universal Precautions shall be observed at all LEHIGH HANSON operations to prevent contact with blood or OPIM. Under circumstances in which differentiation between body fluid types is difficult or impossible, all body fluids shall be considered to be potentially infectious. Supervisors of employees who encounter occupational exposure to blood or OPIM are responsible for ensuring that employees observe Universal Precautions at all times.

B. Work Practice Controls

- Work Practice Controls shall be utilized at all LEHIGH HANSON operations as the primary method for eliminating or controlling occupational exposure to blood or OPIM. The plant manager is responsible for monitoring and maintaining Work Practice Controls.

C. Personal Protective Equipment (PPE)

- Appropriate personal protective equipment shall be used when there is a possibility of occupational exposure to blood or OPIM. Personal protective equipment will be considered "appropriate" only if it prohibits blood or OPIM from coming in contact with an employee's clothing, skin, eyes, mouth, or other mucous membranes under normal conditions of use and for the duration of time which the protective equipment will be used. Appropriate personal protective equipment includes safety glasses, goggles, face shields, latex gloves and CPR barrier shields. All garments that are penetrated by blood shall be removed immediately or as soon as possible. These garments will be handled with protective gloves and other protective personal protective equipment. These garments will either be laundered with soap and water, using appropriate personal protective equipment, or shall be properly disposed of in color-coded and labeled bags.
- Appropriate personal protective equipment shall be maintained in each first aid kit located at the site.

BLOODBORNE PATHOGENS (OSHA Operations)

- Handwashing facilities, which include soap and running water and clean cloth/paper towels, shall be readily accessible to employees.
- LEHIGH HANSON shall provide appropriate personal protective equipment to employees at no cost to the employee. The plant manager shall be responsible for ensuring that employees wear appropriate personal protective equipment.
- All employees having administered first aid or having been exposed to OPIM shall remove and properly dispose of all contaminated disposable personal protective equipment, such as latex gloves, in color-coded and labeled bags. Other personal protective equipment, such as safety glasses, shall be washed completely with soap and running water. All employees shall thoroughly wash their hands and other contaminated skin with soap and running water, upon removal, disposal and/or cleaning of personal protective equipment.

D. Housekeeping

- LEHIGH HANSON will ensure that the work site is maintained in a clean and sanitary condition where blood or OPIM is concerned.
- Where possible, employees shall not eat, drink, apply cosmetics or lip balm, smoke, or handle contact lenses. Food and beverages shall not be kept in or adjacent to any area where blood or OPIM are present. Any contaminated work surface shall be decontaminated as soon as possible after any spill of blood or OPIM. Decontamination shall be accomplished utilizing a solution comprised of one part bleach and nine parts water.
- All pails, mops and other non-disposable items used in the decontamination process shall be thoroughly decontaminated after each use with a bleach solution comprised of one part bleach and nine parts water. All disposable items used in the decontamination process shall be placed in color-coded and labeled bags and disposed of by an authorized disposal company.

E. Sharps Containers

- LEHIGH HANSON shall provide sharps containers at all sites where employees, due to documented medical conditions such as diabetes, must use hypodermic needles and syringes. Contaminated sharps (hypodermic needles) shall be discarded immediately or as soon as feasible in these accessible sharps containers.
- It shall be the responsibility of employees to make this need known to the plant manager.
- Sharps containers shall be:
 - Closable.
 - Puncture resistant.
 - Leakproof on sides and bottom.
 - Labeled or color-coded.

BLOODBORNE PATHOGENS (OSHA Operations)

- During use, sharps containers shall be:
 - Easily accessible to personnel and located as close as is feasible to the immediate area where sharps are used.
 - Maintained upright throughout use.
 - Replaced routinely and not be allowed to overfill.
- When replacing sharps containers, the containers shall be:
 - Closed immediately prior to replacement to prevent spillage or protrusion of contents during handling, storage, transport or shipping.
 - Placed in a secondary container if leakage is possible, with the secondary container being:
 - ✓ Closable.
 - ✓ Constructed to contain all contents and prevent leakage during handling, storage, transport or shipping.
 - ✓ Labeled or color-coded.

F. Labeling

- All materials contaminated with blood or OPIM, including latex gloves, shall be placed in color-coded and labeled bags and disposed of by an authorized regulated waste disposal company. The plant manager shall ensure that labels shall be affixed to all containers of regulated waste and OPIM.
- All labeling and color-coding shall meet the requirements of 29 CFR 1910.1030.

G. Training

- Employees designated as first aid providers will be given appropriate training in the following topics:
 - LEHIGH HANSON's Exposure Control Plan.
 - Epidemiology and symptomatology of bloodborne diseases.
 - Modes of transmission of bloodborne pathogens.
 - Procedures which might cause exposure to blood or OPIM; that is, the administering of first aid.
 - Control methods that will be used at the facility to control exposure to blood or OPIM.
 - Personal protective equipment available at the respective facility and who should be contacted concerning its use.
 - Information on the hepatitis B vaccine, including information on its efficacy, safety, method of administration, the benefits of being vaccinated, and that the vaccine and vaccination will be offered free of charge.
 - Information on the appropriate actions to take and persons to contact in an emergency involving blood or OPIM.
 - Explanation of the procedure to follow if an exposure incident occurs, including the method of reporting the incident.
 - Post exposure evaluation and follow-up.

BLOODBORNE PATHOGENS (OSHA Operations)

- Signs and biohazards labels used at the facility.
 - Opportunity to have questions answered by the person conducting the training.
 - Employees designated as first aid providers shall be instructed annually in the bloodborne pathogens training topics listed above.
 - Training pertaining to the potential hazards and precautions associated with exposure to blood or OPIM shall be included as part of the general first aid training that all employees receive with bloodborne pathogens being a periodic safety-training topic.
- H. Hepatitis B Vaccination
- LEHIGH HANSON shall make hepatitis B vaccine and vaccination series available to all employees who have occupational exposure.
 - The hepatitis B vaccine and vaccination series shall be made available to employees at no cost to the employee.
 - The hepatitis B vaccination series shall be made available to all employees with the potential for exposure after an employee has received training as outlined above and within 10 working days of initial assignment, unless the employee has previously received the complete hepatitis B vaccination series, antibody testing has revealed that the employee is immune, or the vaccine is contraindicated for medical reasons.
 - The vaccination series shall be performed by or under the supervision of a licensed physician or other licensed healthcare professional.
 - Any employee declining to accept the offered hepatitis B vaccination series shall be required to sign the "Hepatitis B Vaccine Declination Form" (included in this section).
 - The hepatitis B vaccination series shall be made available to any employee who initially declined the hepatitis B vaccination series, but who decides to accept the vaccination at a later date.
- I. Post-Exposure Evaluation and Follow-up
- When an employee incurs an exposure incident, it should be reported to the plant manager immediately. All employees who incur an exposure incident shall be offered a post-exposure evaluation by a health care professional and a follow-up in accordance with the OSHA standard. This follow-up will include the following:
 - Documentation of the route of exposure and the circumstances related to the incident.
 - The identification of the source individual and the status of the source individual, if possible.
 - The blood of the source individual will be tested (after consent is obtained) for the HIV/HBV infectivity.

BLOODBORNE PATHOGENS (OSHA Operations)

- If the source individual is already known to be infected with the HIV or HBV, testing for that individual's known HIV/HBV status will not be repeated.
- Results of testing of the source individual will be made available to the exposed employee after the exposed employee is informed about the applicable laws and regulations concerning disclosure of the identity and infectivity of the source individual.
- The employee will be offered the option of having blood collected for testing of the employee's HIV/HBV serological status.
- The employee's blood sample will be preserved for up to 90 days to allow the employee to decide if the blood should be tested for HIV serological status; however, if the employee decides prior to that time that testing will or will not be conducted, then the appropriate action can be taken and the blood sample discarded.
- The employee will be given appropriate counseling concerning precautions to take during the period after the exposure incident and will also be given information on what potential illnesses to be alert for and to report any related experiences.
- The plant manager and the respective safety director have been designated to assure that the policy outlined here is effectively carried out as well as to maintain records related to this policy.

J. Interaction with Health Care Professionals

- A written opinion shall be obtained from a health care professional in the following instances:
 - When an employee is sent to obtain the Hepatitis B vaccine.
 - When an employee is sent to a health care professional following an exposure incident.
- LEHIGH HANSON shall obtain and provide the employee with a copy of the evaluating healthcare professional's written opinion within 15 days of the completion of the evaluation.
- Health care professionals shall be instructed to limit their written opinions for Hepatitis B vaccinations to the following:
 - Whether the Hepatitis B vaccine is indicated for the employee.
 - If the employee has received the vaccine.
- Health care professionals shall be instructed to limit their written opinions for post-exposure evaluations and follow-ups to the following:
 - That the employee has been informed of the results of the evaluation.
 - That the employee has been told about any medical conditions resulting from exposure to blood or OPIM.
 - That this written opinion, which is sent to the employer, is not to reference any personal medical information.

BLOODBORNE PATHOGENS (OSHA Operations)

K. Recordkeeping

- The plant manager shall maintain all records including a list of designated first aid providers, training records and medical records.
- A list of designated first aid providers shall be maintained as part of the "Emergency Action Plan" which is included in the Emergency Action Plan section of the manual. A list of designated first aid providers and their responsible work area(s) shall be maintained on the form entitled "Bloodborne Pathogens Exposure Determination" (included in this section).
- Training shall be documented by means of LEHIGH HANSON "Training Documentation Forms" and/or LEHIGH HANSON "Safety Meeting Forms" and a copy shall be placed in each employee's file (see Training section of manual). Training records shall be retained for a period of three years from the date of the training and shall include the following information:
 - Employee's name.
 - Date of training.
 - Outline describing the training material.
 - Signature of trainer documenting that training was provided.
 - Signature of employee documenting that training was received.
- Medical records, which result due to an exposure incident, shall not be disclosed without an employee's written consent. These records shall be maintained for at least the duration of employment plus 30 years. The records shall include:
 - The name and Social Security number of the employee.
 - Copy of the employee's HBV vaccination status, including the dates of vaccination and ability to receive vaccination.
 - Copy of all results of examination, medical testing, and follow-up procedures.
 - Confidential copy of the health care professional's opinion.

2. STATUTORY REFERENCES

2.1. 29 CFR § 1910.1030 – Bloodborne Pathogens

2.2. 29 CFR § 1910.1030, Appendix. A – Hepatitis B Vaccine Declination Form

HEARING PROTECTION (OSHA Operations)

1. CORPORATE POLICY, REQUIREMENTS AND PROCEDURES

1.1. **Purpose** – To establish requirements and procedures to reduce or protect employees against the overexposure to noise.

1.2. Definitions

- A. Action level (AL) - An 8-hour time-weighted average sound level (TWA_8) of 85 dBA, or equivalently a dose of 50%, integrating all sound levels from 80 dBA to at least 130 dBA.
- B. Audiogram – A chart, graph or table resulting from an audiometric test showing an individual's hearing threshold levels as a function of frequency.
- C. PEL – Permissible Exposure Level – Defined in the chart below.
- D. Standard Threshold Shift – A change in hearing threshold relative to the baseline audiogram of an average of 10 dB or more at 2000, 3000, and 4000 Hz in either ear.
- E. TWA (Time-Weighted Average) – That sound level, which if constant over an eight-hour exposure, would result in the same noise dose as is measured. The sound level at which, if constant over an eight-hour exposure, injury can result.

1.3. **Hazard Assessment and Determination of Noise Exposure** – The workplace shall be assessed to determine if permissible noise exposures are exceeded and to define those areas where permissible noise exposures are exceeded.

- A. Hazard assessments shall be conducted by the plant manager or his designee, with the assistance of safety personnel. Noise meters and dosimeters shall be used to measure sound levels.
 - Hazard assessments shall be conducted whenever a change in production, process, equipment or controls increases noise exposure to the extent that additional employees may be exposed at or above the action level.
 - Hazard assessments shall be conducted whenever a change in production, process, equipment or controls increases noise exposure to the extent that the hearing protection currently being used by employees may not provide sufficient protection against overexposure to permissible noise levels.
- B. Permissible noise exposures shall be defined as:

Duration Per Day, hours of exposure	Sound Level dBA, slow response
8	90
6	92

HEARING PROTECTION (OSHA Operations)

Duration Per Day, hours of exposure	Sound Level dBA, slow response
4	95
3	97
2	100
12	102
1	105
2	110
3 or less	115

- C. To ensure a continuing and effective program, noise exposure will be routinely monitored using dosimeters. This monitoring shall be repeated whenever there is a change in the production process, equipment or controls that increase noise exposures.
 - D. Monitoring shall also be conducted in areas where employee exposure may equal or exceed an eight-hour TWA of 85 dBA.
 - E. Noise exposure computations shall be completed in accordance with 29 CFR § 1910.95 Appendix A.
- 1.4. Noise Exposure (Engineering Controls)** – Excessive noise from equipment will first be reduced as much as possible through engineering controls. Examples of engineering controls are:
- A. Improving muffler type and location.
 - B. Enclosing equipment cabs.
 - C. Enclosing equipment operator stations.
 - D. Installing sound insulating materials.
- 1.5. Noise Exposure (Administrative Controls)** – When practical, employees shall be kept out of areas where noise is likely to be in excess of 85 dBA, or employees will be rotated in and out of the areas during their shift.
- 1.6. Hearing Protection** – Operators of equipment with noise levels more than 85 dBA, that cannot be reduced to below the action level, will be supplied with hearing protection.
- A. Use of hearing protection shall be mandatory when:
 - Operating equipment which emits noise greater than 85 dBA.

HEARING PROTECTION (OSHA Operations)

- Operating equipment which is posted as requiring the use of hearing protection (regardless of the length of exposure).
 - Working in posted areas (regardless of the length of exposure).
 - Prior to an accurate evaluation of the exposure where initial tests indicated that exposures of 85 dBA are likely to be exceeded.
- B. Appropriate hearing protection will be supplied by the company, where required.
- Appropriate hearing protection is hearing protection that effectively attenuates noise to a level that reduces employee exposure to a TWA of 85 dBA. The effectiveness of hearing protection shall be estimated in accordance with 29 CFR § 1910.95 Appendix B.

1.7. Assessment

- A. General guidelines shall be followed when assessing hearing hazards that exist in the workplace and when matching hearing protection equipment to the particular hazards found. It shall be the responsibility of the plant manager, with the assistance of the Safety Department, to select the appropriate hearing protection equipment based on the particular hazards found during the assessment of a site.
- B. The plant manager or his designee shall verify that the required workplace hazard assessment has been performed through a written certification that identifies:
- The workplace evaluated.
 - The name of the person certifying that the evaluation has been performed.
 - The date(s) of the hazard assessment.
 - The document as a certification of hazard assessment.
 - Refer to the form entitled "Workplace Hazard Assessment Certification Form," included in this section.
- C. The following procedure should be followed in assessing workplace hazards:
- Conduct a walk-through survey of all work areas, giving consideration to noise levels.
 - During the walk-through survey, observations shall be made as to the sources of noise.
 - During the walk-through survey monitoring of the workplace shall be conducted to determine if permissible noise exposures are exceeded.
 - In addition to the walk-through, all hearing loss records should be reviewed to help identify possible problem areas.
- D. Upon completion of the walk-through, monitoring and review of records, all information should be organized and reviewed in order to best determine all possible hazards in the workplace and to best select hearing protection equipment to protect against those hazards.

HEARING PROTECTION (OSHA Operations)

- E. Required hearing protection equipment selection can be documented on the form entitled, "Job Specific Personal Protective Equipment Requirements," included in the Personal Protection Equipment section of this manual.

1.8. Hearing Conservation Program

- A. A hearing conservation program shall be administered whenever employee noise exposures equal or exceed an eight-hour TWA of 85 dBA. For purposes of the hearing conservation program, employee noise exposures shall be computed in accordance with 29 CFR § 1910.95 Appendix A and Table G-16a, and without regard to any attenuation provided by the use of personal protective equipment.
- When information indicates that any employee's exposure may equal or exceed an eight-hour TWA of 85 dBA, a monitoring program shall be implemented
 - All monitoring shall be conducted in accordance with 29 CFR § 1910.95.
 - Each employee exposed at or above an eight-hour TWA of 85 dBA shall be notified of the results of the monitoring.
 - Monitoring shall be repeated whenever a change in production, process, equipment or controls increases noise exposures to the extent that:
 - Additional employees may be exposed at or above an eight-hour TWA of 85 dBA.
 - The attenuation provided by hearing protectors currently being used by employees may be rendered inadequate to effectively attenuate sound levels below that necessary to reduce employee exposure to a eight-hour TWA of 90 dBA for all employees and to a eight-hour TWA of 85 dBA for employees with a standard threshold shift.

1.9. Audiometric Testing

- A. Audiometric testing shall be conducted annually for all employees at no cost to the employee. Any employee electing to not participate in audiometric testing shall complete and sign the form entitled "Employee Refusal of Audiogram Certificate" (included in this section).
- B. A baseline audiometric test shall be conducted for all new hires at the time of hire. This baseline test shall be used to determine any future hearing loss.
- C. Audiometric tests shall be conducted in accordance with 29 CFR § 1910.95 and records shall include the following information:
- Name of employee.
 - Job description of employee.
 - Date of audiogram.
 - Name of person (firm) conducting audiogram.

HEARING PROTECTION (OSHA Operations)

- Date of last audiometer's calibration.
 - Employee's most recent noise exposure assessment, if any.
- D. If an annual audiogram indicates that an employee has suffered a standard threshold shift, a retest shall be obtained within 30 days and the results of the retest shall be considered as the annual audiogram.
- E. If a standard threshold shift occurs, the affected employee shall be informed of this fact in writing, within 21 days of the determination.
- In determining whether a standard threshold shift has occurred, allowance may be made for the contribution of aging (presbycusis) to the change in hearing level. These allowances shall be made by correcting the annual audiogram in accordance with the procedure described in 29 CFR § 1910.95 Appendix F.
- F. If it is determined that the standard threshold shift is work related or aggravated by occupational noise exposure, the following steps shall be taken:
- The employee shall be refitted and retrained in the use of hearing protectors and provided with hearing protectors offering greater attenuation if necessary.
 - The employee shall be referred for a clinical audiological evaluation or an otological examination, as appropriate, if additional testing is necessary and/or if it is suspected that a medical pathology of the ear is caused or aggravated by the wearing of hearing protectors.
 - The employee shall be informed of the need for an otological examination if a medical pathology of the ear that is unrelated to the use of hearing protectors is suspected.

1.10. Hearing Protection Policy and Procedures

- A. All site employees will be issued hearing protection at their safety orientation.
- B. All employees are required to have their hearing protection immediately available while on site.
- C. Hearing protection is available at the job-site offices or from supervisors. Employees shall be given the opportunity to select their hearing protectors from a variety of appropriate hearing protectors supplied by the company.
- D. If the wearing of hearing protection is troublesome, hearing protection should be worn until such time as a supervisor has been contacted and the supervisor has provided an alternative means of protection.
- E. If the necessity of wearing hearing protection is in doubt, hearing protection should be worn until such time as an accurate evaluation of the daily exposure indicates that exposures of 85 dBA will not be exceeded.

HEARING PROTECTION (OSHA Operations)

1.11. Training

- A. Employees will be instructed in the proper use of and the importance of hearing protection. This training shall include:
 - The effects of noise on hearing.
 - The purpose of hearing protectors.
 - The advantages, disadvantages and attenuation of various types.
 - Instructions on selection, fitting, use and care.
 - The purpose of audiometric testing.
 - An explanation of the test procedures.
- B. This training shall include a process by which each employee shall demonstrate an understanding of the training provided and demonstrate the ability to use PPE properly, before an employee shall be allowed to perform work requiring the use of PPE.
 - In cases where management does not believe that an employee has adequate understanding and ability, the employee shall receive additional training.
- C. Noise exposure and the topics listed above will be a periodic safety-training topic on an annual basis.

1.12. Posting

- A. Equipment for which operators are required to wear hearing protection will have a sign posted which will be visible from the operating position. (See Example 1.)
- B. Where practical, locations where the noise exposure is likely to exceed 85 dBA will be posted. (See Example 2.)
- C. Where practical, signage will be posted at locations where maximum exposure time in the area is limited. (See Example 3.)
- D. At locations where sound levels exceed 85 dBA, copies of 1910.95 Occupational Noise Exposure shall be made available to affected employees or their representatives and shall also be posted in the workplace per 29 CFR § 1910.95(l)(1).

1.13. Monitoring and Enforcement – Safety personnel and/or supervisors will monitor and enforce the wearing of hearing protection, will post signs on noisy equipment and noisy areas, and will use hand-held noise meters to make spot noise level checks. Employees who refuse to wear hearing protection will be subject to disciplinary action.

1.14. Recordkeeping

- A. The plant manager or his designee shall maintain all records including assessment, inspection, exposure measurements, audiometric test records, and training records. (In some instances, medical records are maintained centrally within a region.)

HEARING PROTECTION (OSHA Operations)

- Noise exposure measurement records shall be retained for two years.
 - Audiometric test records shall be retained for the duration of the affected employee's employment.
- B. Training shall be documented by means of LEHIGH HANSON "Training Documentation Forms" and/or LEHIGH HANSON "Safety Meeting Forms" and a copy shall be placed in each employee's file (see Training section of this manual). Training records shall be retained for a period of three years from the date of the training and shall include the following information:
- Employee's name.
 - Date of training.
 - Outline describing the training material.
 - Signature of trainer documenting that training was provided.
 - Signature of employee documenting that training was received.

2. STATUTORY REFERENCES

- 2.1. 29 CFR § 1910.95 – Occupational noise exposure.

**HEARING PROTECTION
(OSHA Operations)**

**HEARING
PROTECTION
REQUIRED WHEN
OPERATING THIS
EQUIPMENT**

EXAMPLE 1

**HEARING PROTECTION
(OSHA Operations)**

**HEARING
PROTECTION
REQUIRED WHEN
ENTERING THIS
AREA**

EXAMPLE 2

SEAT BELTS (OSHA Operations)

1. CORPORATE POLICY, REQUIREMENTS AND PROCEDURES

- 1.1. **Purpose** – To establish the requirements regarding the mandatory use of seat belts.
- 1.2. **Requirements** – This policy applies to all employees of LEHIGH HANSON and to all persons who operate vehicles on LEHIGH HANSON property. Visitors and contractors shall provide and wear seat belts while on LEHIGH HANSON property. All persons transported in vehicles containing rear seat belts shall wear the provided equipment.
- A. The wearing of seat belts is a mandatory requirement in the following circumstances:
- While operating seat belt equipped vehicles that are owned, leased or rented by LEHIGH HANSON.
 - While traveling in a vehicle on property that is owned by LEHIGH HANSON.
 - While performing business on behalf of LEHIGH HANSON.
- B. All licensed over-the-road vehicles shall be equipped with seat belts that meet Federal Motor Vehicle Safety Standards. Approval stamps that exhibit compliance with this standard are:
- FMVSS.
 - FMV-209.
 - FMV-302.
- C. All off-road vehicles or machines described in 29 CFR § 1926.1000, including off-road trucks, shall be equipped with seat belts that comply with the requirements of SAE J386.
- D. Applicability of “point of attachment” tethers shall be confirmed with the equipment manufacturer and documented in each respective equipment file. If required, tethers shall be installed and maintained in accordance with OEM standards.
- E. Grader operators in the standing position shall wear a safety harness and line while the machine is in motion. When seated, grader operators shall wear seat belts that comply with the requirements of SAE J386.
- 1.3. **Maintenance** – Each vehicle/equipment operator shall be responsible for inspecting and assuring that each provided personal restraint system (seat belts and tethers) is maintained, easily accessible and in good working condition. Worn or damaged belts shall be replaced with belts meeting the requirements of SAE J386. Replacement belts shall meet OEM standards. Vehicles/equipment with damaged belts shall be tagged and removed from service until the belts are replaced in accordance with this policy.
- 1.4. **Training** – Employees shall be trained in the proper use of seat belts and the penalties associated with noncompliance with this policy.
- 1.5. **Monitoring and Enforcement** – Plant managers, safety personnel and/or supervisors will monitor and enforce this policy. Employees who refuse to adhere to the requirements of this policy shall be subject to disciplinary action.

SEAT BELTS (OSHA Operations)

1.6. Recordkeeping

- A. The plant manager or his designee shall maintain all training records.
- B. Training shall be documented by means of LEHIGH HANSON "Training Documentation Forms" and/or LEHIGH HANSON "Safety Meeting Forms" and a copy shall be placed in each employee's file (see the Training section of this manual). Training records shall be retained for a period of three years from the date of the training and shall include the following information:
 - Employee's name.
 - Date of training.
 - Outline describing the training material.
 - Signature of trainer documenting that training was provided.
 - Signature of employee documenting that training was received.

2. STATUTORY REFERENCES

- 2.1. 29 CFR § 1926.602 – Material handling equipment.
- 2.2. 29 CFR § 1926.1000 – Rollover protective structures (ROPS) for material handling equipment.
- 2.3. 30 CFR § 56.14130 – Rollover protection structures (ROPS) and seat belts (for surface equipment).
- 2.4. 30 CFR § 56.14131 – Seat belts for (surface) haulage trucks.

Lehigh Hanson
HEIDELBERGCEMENT Group

**Confined Space Policy
OSHA Operations**

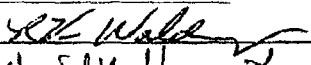
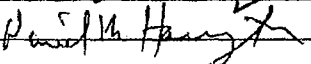
Effective Date	<u>March 1, 2011</u>		
Revision Date	<u> </u>		
Approval	<u></u>	Date	<u>02/18/11</u>
Approval	<u></u>	Date	<u>02/18/11</u>

CONFINED SPACE ENTRY (OSHA Operations)

1. CORPORATE POLICY, REQUIREMENTS AND PROCEDURES

1.1. Purpose – To establish requirements, procedures and conditions with regards to identification, posting and entry of confined spaces in order to eliminate or control employees' exposure to hazardous conditions.

1.2. Definitions

- A. Alternate Entry Procedure – Entry into a permit required confined space (PRCS) under other than PRCS procedures due to the ability to eliminate physical hazards without making entry into the space and the ability to maintain a safe atmosphere by use of forced air ventilation alone.
- B. Confined Space – A space that:
 - Is large enough and so configured that an employee can bodily enter and perform assigned work.
 - Has limited or restricted means for entry or exit.
 - Is not designed for continuous employee occupancy.
- C. Entry – The action by which a person passes through an opening into the confined space. Entry includes ensuing work activities in that space and is considered to have occurred as soon as any part of the entrant's body breaks the plane of the opening of the space.
- D. Hazardous Atmosphere – An atmosphere that may expose employees to the risk of death, incapacitation, impairment of ability to self-rescue (unaided escape for the space), injury or acute illness from one or more of the following causes:
 - Flammable gas, vapor or mist in excess of ten (10) percent of its lower explosive limit (LEL) or lower flammable limit (LFL).
 - Airborne combustible dust at a concentration that meets or exceeds its LEL/LFL. This concentration may be approximated as a condition in which the dust obscures vision at a distance of five feet or less.
 - Ambient oxygen concentration below nineteen and one-half percent (19.5%) or above twenty-three and one-half percent (23.5%).
 - Atmospheric concentration of any substance that is capable of causing death, incapacitation, impairment of ability to self-rescue, injury or acute illness due to its health effects.
 - Any other atmospheric condition that is immediately dangerous to life or health.
- E. Immediately Dangerous to Life or Health (IDLH). – Any condition that poses an immediate or delayed threat to life that would cause irreversible adverse health effects; or that would interfere with an individual's ability to escape unaided from a confined space.
- F. Non-Permit Confined Space – A confined space that does not contain, or with the respect to atmospheric hazards, have the potential to contain any hazard capable of causing death or serious physical harm.

CONFINED SPACE ENTRY (OSHA Operations)

- G. Oxygen Deficient Atmosphere – An atmosphere containing less than 19.5% oxygen by volume.
- H. Oxygen Enriched Atmosphere – An atmosphere containing more than 23.5% oxygen by volume.
- I. Permit-Required Confined Space (PRCS) – A confined space that has one or more of the following characteristics:
 - Contains or has the potential to contain a hazardous atmosphere.
 - Contains a material that has the potential for engulfing an entrant.
 - Has an internal configuration such that an entrant could be trapped or asphyxiated by inwardly converging walls or by a floor, which slopes downward and tapers to a smaller cross section.
 - Contains any other recognized serious safety or health hazard.
- J. Reclassification of PRCS – A PRCS with one or more of the physical hazards in section 1.2.I, but does not contain, or have the potential contain, a hazardous atmosphere, and the physical hazards can be eliminated without entry into the PRCS.

1.3. Requirements

- A. Workspace Evaluation
 - Using the “Confined Space Entry and Reclassification Decision Flow Chart” (included in this section), the Plant Manager and Safety Department shall evaluate the workplace annually to identify all confined spaces that;
 - Meets the definition of Section 1.2.B and;
 - Meets the definition of Section 1.2.I.
 - PRCS' will be identified in this section on the form entitled “Confined Space Identification Form” included in this section.
 - Employees will be informed of all spaces meeting the above criteria by means of training, information sharing and by means of posted danger signs. All signs shall read: **DANGER – Permit-Required Confined Space – Do Not Enter.** (Example included in this section.)
 - Workplace evaluation and reclassification to Non-Permit Required Confined Spaces (NPRCS) shall be completed when there are changes in the use or configuration of the NPRCS that might increase or change the hazards to entrants.
 - Workplace evaluation and an annual reclassification, where applicable, of confined spaces shall be completed within 12 months of the previous annual evaluation. To ensure compliance it is suggested that the evaluation be completed within 11 months of the previous annual evaluation.
 - If changes resulting from an evaluation of confined space require reclassification of the space to a PRCS, employees shall be informed that the space meets the permit-required criteria by means of training, information sharing and posting.

CONFINED SPACE ENTRY (OSHA Operations)

- Employees shall not enter confined spaces that have been evaluated and determined to be PRCS; that is, they meet the definition of section 1.2.B and 1.2.I., unless the Plant Manager or Safety Department approves the entry upon documented elimination of the hazards present and reclassification is completed or entry via Alternate Entry Procedures is applicable.
- Acceptable hazard elimination methods include, but are not limited to:
 - Elimination of atmospheric hazards and maintaining a safe atmosphere by use of forced air ventilation alone without entry into the space.
 - Removal of material that has the potential for engulfing and lockout/tagout of equipment which control the supply and discharge of material without entry into the space.
 - Stabilization of material that has the potential for engulfing and lockout/tagout of equipment which control the supply and discharge of the material without entry into the space.
- Documented hazard elimination means that upon completion of hazard elimination procedures and completion of the original hazard evaluation procedure, no hazards have been found to exist, or have the potential to exist, in the confined space. The Plant Manager, his designee or Safety Department shall document these findings before entrance shall be permitted.
 - The form entitled "Confined Space Alternate Procedure Entry Permit" (included in this section) shall be used to document the elimination of hazards present, including a known or potential hazardous atmosphere, in a PRCS and the reclassification of the confined space to NPRCS under Alternate Entry Procedures.
 - The form entitled "Confined Space Reclassification Form" (included in this section) shall be used to document the elimination of physical hazards (no known or potential hazardous atmosphere) prior to entry into the PRCS and the reclassification of the space to NPRCS.

B. Testing and Elimination of Hazardous Atmospheres

- Persons conducting evaluation tests shall be trained and competent in the use and calibration of test instruments and in the documentation of calibration and test results. Test instrument alarms shall be set to alarm at the appropriate action level to signal the evacuation warning.
- Test instruments shall be calibrated as suggested by the instrument manufacturer. The calibration shall be documented on the form entitled "Calibration Record", included in this section. The person completing the form shall initial and date the form upon completion of the test. Calibration records shall be reviewed prior to instrument use to ensure compliance. The most recent calibration record must be available for inspection.
- Without entering the confined space, the existing atmosphere must be tested for the following, in the order listed, be within the **Acceptable Limits** specified and recorded:

CONFINED SPACE ENTRY (OSHA Operations)

<u>Test for:</u>	<u>Acceptable Limits:</u>
Oxygen Content	19.5% - 23.5%
Lower Explosive Limit (LEL)	<10%
Carbon Monoxide	<35 PPM
Hydrogen Sulfide	<10 PPM
Other atmospheric hazard	OSHA acceptable limits

- If the atmosphere is not within above noted acceptable limits and the hazards cannot be eliminated and maintained within acceptable limits, the confined space shall be classified as a PRCS and shall not be entered. The space shall be identified per 1.3 A., Workplace Evaluation.
- If the atmosphere is not within **Acceptable Limits**, but the atmospheric hazard can be eliminated through positive pressure ventilation, then entry via Alternate Entry Procedures can be completed.
- During ventilation, the atmosphere must be tested without entry into the confined space. Upon determining the atmosphere to be acceptable and that all other hazards have been eliminated, then entry can be made. The pre-entry, post-ventilation atmospheric reading shall be recorded on the Alternate Entry Procedure Form.
- Upon entering the confined space, the atmosphere shall preferable be tested continuously with an alarmed system. If not continuous then the atmosphere in the space shall be tested at least every 15 minutes and the results recorded not to exceed 2-hour intervals.
- During the time personnel are in the confined space, should atmospheric conditions fall outside **Acceptable Limits**, all employees shall **IMMEDIATELY** evacuate the space. The space shall then be evaluated to determine the cause and proper measures taken to eliminate the cause before personnel shall be allowed to re-enter the space. Documentation of procedures taken to correct the hazard shall be documented.
- Proper positive pressure ventilation from a clean, 100 percent outside source of the confined space must be maintained for the duration of the entry. Additional covers, lids, hatches, manhole covers etc should be removed to aid in cross circulation.
- When applicable, portable blowers/ventilators shall be set up to exhaust fumes, vapors, smoke, and mists which may be generated by welding, painting, cutting, or other such activities within the confined space.
- Pumps, generators, gas powered ventilation systems, mobile equipment and other equipment that has the potential to generate carbon monoxide, shall be located a sufficient distance from the confined space to prevent introducing a hazardous atmosphere into the space. The equipment should be located downgrade and downwind as practical.

CONFINED SPACE ENTRY **(OSHA Operations)**

C. Control of Engulfment Hazards

- Persons can be engulfed if bridged material collapses or if material sloughs off the side of storage bins, hoppers or silos. Material feeding onto belts or from/onto other discharge points can bury or draw victims into augers, gates or holes causing an engulfment incident.
- Work on or above materials in these structures shall be performed from safe access platforms with handrail or other competent person approved fall protection system. Work in areas that have an engulfment hazard shall not begin until material that presents the hazard has been removed, belts, gates, augers, etc has been locked and tagged out by the entrant. Effective methods shall be used to prevent loaders and trucks from dumping or loading the space. Refer to Lockout Tagout section of this manual.
- Material that presents a potential for caving; sliding or sloughing shall be scrapped or barred down from the top and sides before entry is made.
- Work shall not be performed in confined spaces until all precautions have been taken to prevent the flow of materials that can potentially cause an engulfment. Precautionary measures taken shall be recorded on the form entitled "Alternate Procedure Confined Space Entry Form" included in this section.

D. Confined Space Entry

- Upon entry approval by Entry Supervisor, all applicable safety practices outlined by OSHA regulation and/or this safety advisory must be followed from such time as the employee enters the confined space, until such time as the employee exits the confined space.
- Employees shall be allowed to enter all confined spaces that have been evaluated and reclassified to be non-permit spaces, that is, it has been determined that no potential atmospheric exist and that all physical hazards can be removed or made safe without entry into the confined space or if a real or potential atmospheric hazard exist the space is made safe and entry is made using the Alternate Entry Procedures. All applicable safety practices outlined by OSHA regulations and/or this safety advisory must be followed from such time as the employee enters the confined space, until such time as the employee exits the confined space.

1.4 Confined Space Procedures

- A. Safety harnesses with shock absorbing lanyard or a harness and lifeline shall be worn when persons enter a confined space that requires fall protection, such as bins, tanks, silos, etc. A competent person shall approve fall protection setup and equipment. The attendant shall tend the lifeline. Refer to Fall Protection section of this manual.
- B. All employee(s) given the responsibility of tending fall protection systems and lifeline(s) shall have the capability of maintaining communications with the employee(s) that enter a confined space from the time of entry until the time of exit.
- C. All required personal protective equipment shall be used when entering a confined space. Refer to Hearing Protection, Personal Protective Equipment and Respiratory Protection sections of this manual.

CONFINED SPACE ENTRY (OSHA Operations)

- D. A barricade or barrier shall be erected at the opening of all confined spaces being entered to prohibit unauthorized persons from entering the space.
- E. Before entering a confined space, the supply and discharge of materials shall be stopped, and all equipment which control the supply and discharge of material or which could create a hazard shall be locked and tagged out by the employee(s) entering the confined space. Refer to Lockout Tagout section of this manual.
- F. The attendant to the entrant(s) shall have knowledge and be capable of summoning rescue and emergency medical assistance in the event of an emergency.

1.5 Training

- A. Employees will be instructed in the recognition of confined spaces; the recognition of potential confined space hazards; confined space entry and exit procedures; required safety equipment, including respirators, rescue retrieval systems, and atmospheric monitoring, as required; summoning rescue, non-entry rescue procedures; first aid; hazard control measures such as lockout/tagout, ventilation and access control; and proper work practices including entry documentation.
- B. Confined space entry and the topics listed above will be a periodic safety-training topic.

1.6 Monitoring and Enforcement – The plant manager shall be responsible for implementation and enforcement of this policy. Failure to follow established confined space entry procedures or failure to use proper personal protective equipment will result in loss of safety incentive bonus and/or progressive disciplinary action up to and including termination of employment.

1.7 Independent Contractors

- A. Independent contractors shall be contracted to perform work that requires the entry into a permit-required space, which cannot be reclassified to a non-permit space or entered through the Alternate Entry Procedures.
- B. When contracting with an outside contractor, who will be required to enter a permit-required space, the Plant Manager of the site shall:
 - Inform the contractor that the workplace contains permit-required confined spaces and that entry into these spaces is allowed only through compliance with OSHA permit required confined space standards.
 - Provide the contractor with information concerning the permit-required spaces, including the hazards identified and any past experience with the space that makes it a permit-required space.
 - Inform the contractor of any precautions or procedures that have been implemented for the protection of employees in or near any and all permit-required spaces where the contractor's personnel will be working.
 - Coordinate entry operations with the contractor, when both LEHIGH HANSON and contractor personnel will be working near the permit-required confined space.

CONFINED SPACE ENTRY (OSHA Operations)

- At the completion of the job requiring entry into the permit required spaces, debrief the contractor regarding the permit space program and any hazards they confronted or created during the entry operations.

1.8 Recordkeeping

- A. The Plant Manager or his designee shall maintain all records including inspection and training records.
- B. Training shall be documented by means of LEHIGH HANSON "Training Documentation Forms", LEHIGH HANSON "Safety Meeting Forms" and/or Certificates of Training provided by outside training sources and a copy shall be placed in each employee's file (see Training section of this manual). Training records shall be retained for a period of three years from the date of the training and shall include the following information:
 - Employee's name.
 - Date of training.
 - Outline describing the training material.
 - Signature of trainer documenting that training was provided.
 - Signature of the employee documenting that training was received.

2. STATUTORY REFERENCES

- 2.1 29 CFR 1910.146 – Permit-required confined spaces.
- 2.2 29 CFR 1910.146 Appendix A – Permit-required confined space decision flow chart.
- 2.3 29 CFR 1910.146 Appendix B – Procedures for atmospheric testing.
- 2.4 29 CFR 1910.146 Appendix C – Examples of permit-required confined space programs.
- 2.5 29 CFR 1910.146 Appendix D – Confined space pre-entry check list.
- 2.6 29 CFR 1910.146 Appendix E – Sewer system entry.
- 2.7 29 CFR 1910.146 Appendix F- Permit-required confined

**CONFINED SPACE ENTRY
(OSHA Operations)**



**DANGER
PERMIT-REQUIRED
CONFINED SPACE
DO NOT ENTER**

EXAMPLE 1

CONFINED SPACE ENTRY (OSHA Operations)

CONFINED SPACE ENTRY and RECLASSIFICATION DECISION FLOW CHART

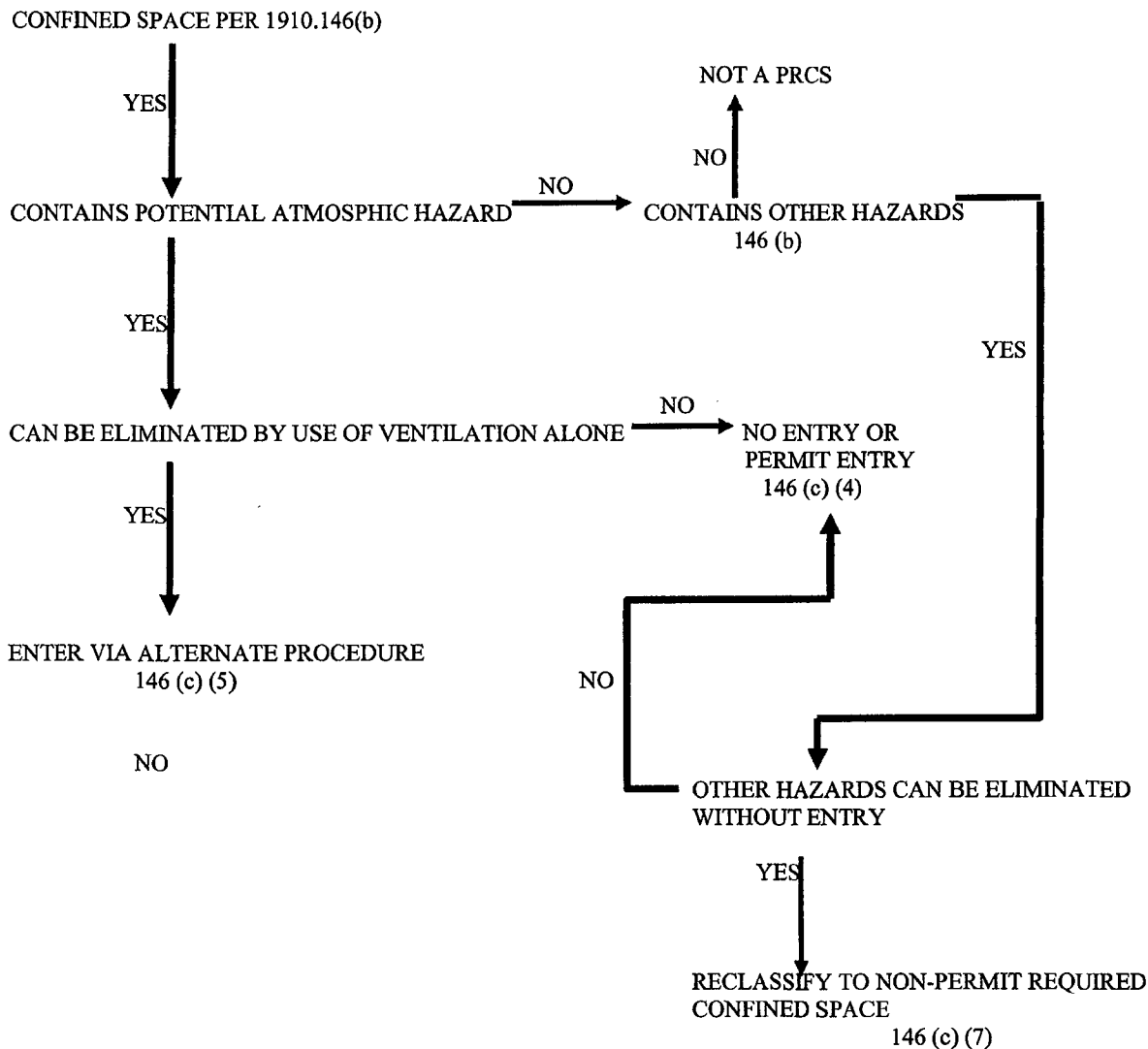

Lehigh Hanson
HEIDELBERGCEMENT Group

Hot Work Policy
OSHA Operations

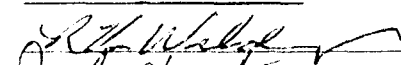
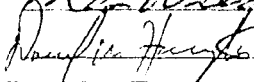
Effective Date	<u>March 1, 2011</u>		
Revision Date	_____		
Approval		Date	<u>02/18/11</u>
Approval		Date	<u>02/18/11</u>

HOT WORK **(OSHA Operations)**

1. CORPORATE POLICY, REQUIREMENTS AND PROCEDURES

1.1. Purpose – To establish requirements, procedures and conditions with regards to the safety and health of all employees conducting hot work and for the protection of property exposed to the hot work.

1.2. Definitions

- A. Combustible Liquid – Any liquid having a flashpoint at or above 100 F.
- B. Combustible Material – Any solid material that is easily ignited such as wood, paper, dry vegetation, etc. and that will freely support combustion once ignited.
- C. Fire Watch – The person assigned to watch for unsafe operations of the hot work task and to inspect and watch for fires resulting from the hot work.
- D. Flame Cutting – Cutting of material using a flame such as oxygen/acetylene torch cutting.
- E. Flammable Liquid – A liquid having a flash point below 100 F.
- F. Grinding – Using an abrasive tool, powered or manual, to smooth or gauge another material or product.
- G. High hazard area – Areas that have or have the potential to contain flammable liquids or vapors, combustible materials or other easily ignitable materials. High hazard areas require a Hot Work Permit to be issued.
- H. Hot work - Hot work is defined as any work that will generate sufficient heat to ignite combustible and/or flammable materials.
- I. Hot work permit – A form that is used as a checklist to ensure hazards associated with the hot work have been identified, removed or guarded and that the hot work is authorized by management.
- J. Lower Explosive Limit - The point at which the minimal amount of flammable vapors mixes with oxygen to form an explosive or flammable atmosphere.
- K. Material Safety Data Sheet – An information sheet provided by the product manufacturer to inform the employee of the hazards associated with the product. Flash points and Lower Explosive Limits can be found on the MSDS.

1.3. Requirements

- A. These requirements cover all hot works as defined throughout this section. Management is responsible for ensuring that employees are notified and trained accordingly. The Plant Manager must ensure that precautions have been taken

HOT WORK (OSHA Operations)

to prevent fires or explosions or any other incident that may result in damage to property or injury to employees as a result of the hot work.

- B. The following activities are examples of hot work (not all inclusive):
- Welding – All types including electric and gas.
 - Flame or plasma cutting.
 - Abrasive grinding.
 - Use of portable heaters or steamers.
 - Use of electrical tools/equipment (that are not explosion proof or intrinsically safe) in explosion hazard areas.
 - Sandblasting operations (static charges).
 - Open burning of wood, trash, etc.
- C. Fire Hazards. If the object that hot work is to be performed on cannot readily be moved, all moveable fire hazards in the vicinity shall be taken out of the hot work area and stored in a safe place.
- D. Guards. If the hot work object cannot be moved and if all the fire hazards cannot be removed, then a hot work permit shall be completed and issued, and guards shall be used to confine the heat, sparks and slag, and to protect the immovable fire hazards.
- E. Restrictions. If these requirements cannot be followed, guarding cannot adequately eliminate the fire hazards or the hot work permit is not authorized then the hot work shall not be performed.

1.4 Special Precautions

When the nature of the work requires guarding of flammable or combustible materials because the hot work cannot be relocated and the flammable or combustible material cannot be removed then certain additional precautions are necessary.

- A. Combustible Material
- Wherever there are floor openings or cracks in the flooring that cannot be closed, precautions shall be taken so that no readily combustible or flammable materials on the floor below will be exposed to sparks or other hot debris which might drop through. The same precautions shall be observed with regard to cracks or holes in walls, open doorways and open or broken windows.

HOT WORK (OSHA Operations)

- Combustible floors and materials (i.e. conveyor belts, polypropylene screen decks, etc.) shall be kept wet, covered with damp sand, or protected by a listed or approved welding blanket, welding pad, or equivalent. Where floors have been wet down, personnel operating arc welding equipment or cutting equipment shall be protected from possible shock.
- B. Fire Extinguishers
- Suitable fire extinguishing equipment (refer to the Fire Safety Plan in this manual) shall be maintained in a state of readiness for instant use. Approved portable fire extinguishers for the type and quantity of the combustible or flammable material exposed shall be within 25 feet of the hot work. The combustible or flammable material shall not be located between the hot work and the fire extinguisher, so as to block ready access to the fire extinguishers in the event of a fire.
- C. Fire Watch.
- Fire watchers shall be required whenever hot work is performed in locations where other than a minor fire might develop, or any of the following conditions exist:
 - Exposed combustible material in buildings closer than 35 feet to the point of the hot work.
 - Combustibles are more than 35 feet away but are easily ignited by sparks.
 - Unguarded wall of floor openings expose combustible material in adjacent areas including concealed spaces in walls or floors.
 - Combustible materials are adjacent to the opposite side of metal partitions, wall, ceilings or roofs and are likely to be ignited by conduction or radiant heat.
 - Fire watchers shall have fire extinguishing equipment readily available and be trained in its use. They shall be familiar with facility alarm systems and how to summon emergency assistance. They shall watch for fires in all exposed areas, attempt to extinguish fire only when the fire extinguishing equipment available is of adequate size to fully extinguish the fire, or otherwise sound the alarm. A fire watch shall be maintained for at least 30 minutes after completion of the hot work to detect and extinguish possible smoldering fires.
 - The fire watcher is authorized to stop work whenever he/she feels the conditions are unsafe. The fire watcher is also authorized to stop the work if the work description on the permit is being exceeded. The supervisor of the hot work activity must be notified of the situation immediately.

HOT WORK **(OSHA Operations)**

- D. Authorization. Before hot work is permitted, the area shall be inspected by the Plant Manager or designated employee authorizing the hot work. They shall designate precautions to be followed in granting authorization and/or requiring and approving the Hot Work Permit
- A hot work permit (included in this section), must be issued before any hot work is performed in areas within 150 feet of flammable liquid storage, potential or actual flammable vapors or within 35 feet of combustible materials that could be impacted or come into contact with the hot work. This requirement applies to all Lehigh Hanson facilities and employees including field operations.
 - Supervisors are responsible for ensuring that all hot work is authorized, that a hot work permit is completed when required, and conditions are acceptable prior to initiating the task.
 - Supervisors shall consider the safety of the hot work operator and fire watch with respect to personal protective equipment (PPE) for other hazards beyond hot work.
 - Personal protective clothing shall be selected to minimize the potential for ignition, burning, trapping hot sparks, and electrical sparks.
- E. Hot work shall not be permitted in the following situations:
- In areas not authorized by management.
 - In sprinkled buildings while such protection is impaired.
 - In the presence of explosive or flammable atmospheres above 10% of the Lower Explosive Limit (LEL) (mixtures of flammable gases, vapors, liquids, or dusts with air), or explosive atmospheres that may develop inside uncleaned or improperly prepared tanks, hoppers, etc. which have previously contained such materials, or that may develop in areas with an accumulation of combustible dust.
 - Refer to Confined Space Entry Procedures if hot work is to be performed in a confined space.
 - In areas near the storage of quantities of exposed, readily ignitable or combustible materials.
- F. Refer to Confined Space Entry Procedures if hot work is to be performed in a confined space.
- G. In areas where the potential for a flammable atmosphere exist, the area must be tested for the presence of flammable or explosive gases or vapors prior to entering the area and constantly during the time workers are present in the area.

HOT WORK **(OSHA Operations)**

- If the concentration exceeds 10 percent of the LEL (lower explosive limit), work shall stop and all personnel shall leave the area until the area can be ventilated and the flammable atmospheric concentration lowered to less than 10% of the LEL.
 - The use of inert gas to eliminate flammable gases in confined spaces is prohibited by Lehigh Hanson Policy. This practice would also displace oxygen thus making the space immediately dangerous to life and health.
 - Positive pressure ventilation as well as local exhaust shall be used to ensure that atmospheric hazard does not accumulate in the hot work area.
- H. Relocation of flammables and combustibles. Where practicable, all flammable liquids shall be relocated at least 150 feet and combustible material 35 feet from the hot work area. Where relocation of combustibles is impracticable, fire proof guarding such as welding tarps, welding shields, metal covers shall be used to cover or protect the combustibles from the hot work.
- If guarding is required due to proximity of the combustibles to the hot work then a hot work permit is required.
 - Flammable liquids shall always be removed at least 150 feet from the hot work or the hot work shall not be conducted.

1.5 Hot Work Permit (Hot Work Procedures in high hazard areas)

- A. Persons performing hot work in high hazard areas must obtain written authorization "Hot Work Permit" from the Plant/Facility Manager or his/her designated supervisory person before beginning hot work.
- B. The permit writer and all involved personnel shall conduct an inspection of the work area and all hot work equipment to ensure that it is safe to proceed.
- C. The permit writer shall complete the hot work permit prior to starting work and must ensure that the individuals performing the hot work and performing the pre-task survey are trained in Lehigh Hanson safety policies as necessary to complete the task.
 - Where appropriate, the area must be surveyed for cracks and/or openings in the floor, wall, etc. that may allow sparks to pass through and ignite combustible material. These openings must be guarded.
 - All ducts and/or conveyor systems that may carry sparks to combustible or explosive materials must be shut down, locked out, tagged out, sealed and covered.
 - Due to the high potential of conveyor fires, hot work near conveyor belts requires a hot work permit and must always be guarded by tarps or other covers and be strictly monitored.

HOT WORK **(OSHA Operations)**

- D. The permit must be reviewed and signed by the employee performing the hot work and by the person authorizing the permit. The supervisor responsible for the area in which hot work is being conducted must be notified of the hot work prior to start up and also sign the permit. The permit will stay in the possession of the employee performing the hot work during the shift.
- E. The person approving the permit must ensure that the area is constantly surveyed to ensure that the conditions remain suitable for hot work. The work area shall be resurveyed following all breaks, meals, meetings or other interruptions in the work, unless the fire watch does not leave the area and stays on duty.
- F. If the conditions change all hot work shall stop. Work shall not resume until the hazardous condition is eliminated; the area is resurveyed and determined to be safe. All stops and restarts shall be recorded on the permit form.
- G. Expired hot work permits shall be kept on file at the facility for at least 12 months beyond their expiration date.
- H. Permits are only valid for one shift not to exceed 8 hours.
- I. Checking and testing that precedes issuance of a permit shall be as close as practical to the time the work is to begin.
- J. The work area shall be rechecked after any break in the job such as meals, breaks, or meetings.
- K. If the area has the potential to contain flammable vapors due to previously stored or residual flammable liquids, an atmospheric meter shall be used to survey the area. No hot work shall begin if concentration of a flammable gas greater than 10% of its LEL is measured. No exceptions to this rule shall be made.
- L. Atmospheric gas detectors shall be calibrated as specified by manufacturer's recommendation.
- M. The fire watch must be on duty at all times during the performance of the work that requires a hot work permit.
- N. In the event the hot work will extend past the permit's expiration time, a new permit must be obtained before the next shift or work period begins.

1.6 PRE-HOT WORK SAFETY MEETING

- A. A safety meeting shall be conducted for hot work and documented by the person supervising the hot work prior to starting work. The meeting will review the following topics:

HOT WORK **(OSHA Operations)**

- Hot work permit and any gas testing requirements
- All flammable liquids removed.
- Combustible material removed from the impact area or protected from the hot work
- Appropriate emergency procedures and notifications
- Ensure area is free of non-essential personnel, equipment, etc.
- Use of personal protective equipment.
- Responsibility of fire watch.
- Blinding, isolation, and purging of equipment.
- Discuss escape routes and emergency assembly area.

1.7 Contractors – Before starting any hot work, contractors and Lehigh Hanson site management shall discuss the planned project completely, including the type of hot work to be conducted and the hazards in the area. All contractors performing hot work on Lehigh Hanson property shall follow the requirements of this policy.

1.8 Monitoring and Enforcement – Safety personnel and/or supervisors will monitor and enforce this policy. Employees who refuse to adhere to the requirements of this policy will be subject to disciplinary action.

1.9 Recordkeeping

- A. The Plant Manager or his designee shall maintain all records including inspection and training records.
- B. Training shall be documented by means of LEHIGH HANSON "Training Documentation Forms", LEHIGH HANSON "Safety Meeting Forms" and/or Certificates of Training provided by outside training sources and a copy shall be placed in each employee's file (see Training section in this manual). Training records shall be retained for a period of three years from the date of the training and shall include the following information:
 - Employee's name.
 - Date of training.
 - Outline describing the training material.
 - Signature of trainer documenting that training was provided.
 - Signature of the employee documenting that training was received.

HOT WORK (OSHA Operations)

1.10 REGULATORY REFERENCES

- 2.1 29 CFR 1910.252 Welding, cutting and brazing
- 2.4 29 CFR 1910.119 Process safety management
- 2.4 29 CFR 1910.253 Oxygen-fuel gas welding and cutting
- 2.4 National Fire Protection Association 51B

Lehigh Hanson
HEIDELBERGCEMENT Group

**Electrical Safety Policy
OSHA Operations**

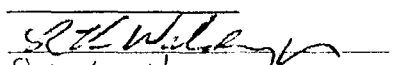
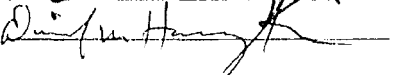
Effective Date	<u>March 1, 2011</u>		
Revision Date	<u> </u>		
Approval		Date	<u>02/18/11</u>
Approval		Date	<u>02/18/11</u>

ELECTRICAL

(OSHA Operations)

1. CORPORATE POLICY, REQUIREMENTS AND PROCEDURES

1.1. Purpose – To establish requirements and procedures for the examination, installation, use and testing of continuity and resistance of electrical power tools, equipment, power cords and receptacles in order to eliminate employees' exposure to hazards.

1.2. Definitions

- A. **Armored Cable** – Type AC armored cable is a fabricated assembly of insulated conductors in a flexible metallic enclosure.
- B. **Askarel** – A generic term for a group of nonflammable synthetic chlorinated hydrocarbons used as electrical insulating media. Askarels of various compositional types are used. Under arcing conditions the gases produced, while consisting predominantly of noncombustible hydrogen chloride, can include varying amounts of combustible gases depending upon the askarel type.
- C. **Attachment Plug (Plug cap)(Cap)** – A device which, by insertion in a receptacle, establishes connection between the conductors of the attached flexible cord and the conductors connected permanently to the receptacle.
- D. **Cable Tray System** – A unit or assembly of units or sections, and associated fittings, made of metal or other noncombustible materials forming a rigid structural system used to support cables. Cable tray systems include ladders, troughs, channels, solid bottom trays and other similar structures.
- E. **Conductor:**
 - **Bare** – A conductor having no covering or electrical insulation whatsoever.
 - **Covered** – A conductor encased within material of composition or thickness that is not recognized as electrical insulation.
 - **Insulated** – A conductor encased within material of composition and thickness that is recognized as electrical insulation.
- F. **Controller** – A device or group of devices that serves to govern, in some predetermined manner, the electric power delivered to the apparatus to which it is connected.
- G. **Device** – A unit of an electrical system which is intended to carry but not utilize electric energy.
- H. **Disconnecting Means** – A device, or group of devices, or other means by which the conductors of a circuit can be disconnected from their source of supply.
- I. **Disconnecting (or Isolating) Switch (Over 600 volts, nominal)** – A mechanical switching device used for isolating a circuit or equipment from a source of power.
- J. **Enclosure** – The case or housing of apparatus; or the fence or walls surrounding an installation to prevent personnel from accidentally contacting energized parts, or to protect the equipment from physical damage.

ELECTRICAL (OSHA Operations)

- K. Equipment – A general term including material, fittings, devices, appliances, fixtures, apparatus and the like, used as a part of, or in connection with, an electrical installation.
- L. Grounded – Connected to earth or to some conducting body that serves in place of the earth.
- M. Grounding Conductor – A conductor used to connect equipment or the grounded circuit of a wiring system to a grounding electrode or electrodes.
- N. Grounding Conductor, Equipment – The conductor used to connect the non-current-carrying metal parts of equipment, raceways, and other enclosures to the system grounded conductor and/or the grounding electrode conductor at the service equipment or at the source of a separately derived system.
- O. Grounding Electrode Conductor – The conductor used to connect the grounding electrode to the equipment grounding conductor and/or to the grounded conductor of the circuit at the service equipment or at the source of a separately derived system.
- P. Ground-Fault Circuit-Interrupter – A device whose function is to interrupt the electric circuit to the load when a fault current to ground exceeds some predetermined value that is less than that required to operate the overcurrent protective device of the supply circuit.
- Q. Labeled – Equipment is "labeled" if there is attached to it a label, symbol, or other identifying mark of a nationally recognized testing laboratory which: (a) makes periodic inspections of the production of such equipment, and (b) whose labeling indicates compliance with nationally recognized standards or tests to determine safe use in a specified manner.
- R. Listed – Equipment is "listed" if it is of a kind mentioned in a list which, (a) is published by a nationally recognized laboratory which makes periodic inspection of the production of such equipment, and (b) states such equipment meets nationally recognized standards or has been tested and found safe for use in a specified manner.
- S. Overcurrent – Any current in excess of the rated current of equipment or the ampacity of a conductor. It may result from overload (see definition), short circuit or ground fault. A current in excess of rating may be accommodated by certain equipment and conductors for a given set of conditions. Hence the rules for overcurrent protection are specific for particular situations.
- T. Overload – Operation of equipment in excess of normal, full load rating, or of a conductor in excess of rated ampacity which, when it persists for a sufficient length of time, would cause damage or dangerous overheating. A fault, such as a short circuit or ground fault, is not an overload.
- U. Raceway – A channel designed expressly for holding wires, cables, or busbars, with additional functions as permitted in this subpart. Raceways may be of metal or insulating material, and the term includes rigid metal conduit, rigid nonmetallic conduit, intermediate metal conduit, liquid-tight flexible metal conduit, flexible metallic tubing,

ELECTRICAL (OSHA Operations)

flexible metal conduit, electrical metallic tubing, underfloor raceways, cellular concrete floor raceways, cellular metal floor raceways, surface raceways, wireways and busways.

- V. Receptacle – A contact device installed at the outlet for the connection of a single attachment plug. A single receptacle is a single contact device with no other contact device on the same yoke. A multiple receptacle is a single device containing two or more receptacles.
- W. Voltage (of a circuit) – The greatest root-mean-square (effective) difference of potential between any two conductors of the circuit concerned.
- X. Voltage, nominal – A nominal value assigned to a circuit or system for the purpose of conveniently designating its voltage class (as 120/240, 480Y/277, 600, etc.). The actual voltage at which a circuit operates can vary from the nominal within a range that permits satisfactory operation of equipment.
- Y. Voltage to ground – For grounded circuits, the voltage between the given conductor and that point or conductor of the circuit that is grounded; for ungrounded circuits, the greatest voltage between the given conductor and any other conductor of the circuit.
- Z. Wireways – Sheet-metal troughs with hinged or removable covers for housing and protecting electric wires and cable, and in which conductors are laid in place after the wireway has been installed as a complete system.

1.3. Requirements

- A. All electric equipment, conductors, etc. and the installation of such equipment, conductors, etc used to provide electric power and light for employee workplaces shall be designed and installed in accordance with the safety standards contained in 29 CFR §1910.302 through 1910.308.
- B. All electrical equipment shall be examined/inspected routinely to ensure that no recognizable hazards exist. Examinations and inspections shall be based on the following:
 - The suitability of equipment for the application, based on listing or labeling of equipment.
 - The classification of equipment, conductors, etc. by type, size, voltage, current capacity, etc.
 - The durability of the equipment for the application, including the protection afforded by enclosures, cabinets, etc.
 - The insulation.
 - The effects of heating and/or arcing under load.
 - Other factors which are designed to provide protection to employees.
- C. All electrical equipment shall be listed or labeled and shall be installed and used in accordance with the information contained in the listing and/or labeling. The following information shall be permanently affixed to and readily visible on all electrical equipment:

ELECTRICAL

(OSHA Operations)

- Manufacturer's name, trademark, etc.
 - Voltage, current, wattage, etc.
- D. When work is to be performed on or around electrical equipment, the following shall be maintained in accordance with 29 CFR § 1910.303:
- Guarding and enclosing of energized components, parts, etc. of electrical equipment.
 - Sufficient access and working space provided and maintained about all electrical equipment to permit ready and safe operations and maintenance.
 - Entrances and access to workspace.
 - Illumination.
- E. All electrical equipment shall be designed, specified, installed and used in accordance with 29 CFR § 1910.304 and the National Electrical Code (NEC).
- F. All unused openings (including conduit knockouts) in electrical enclosures and fittings shall be closed with appropriate covers, plugs or plates.
- G. All electrical enclosures such as switches, receptacles and junction boxes shall be provided with tight-fitting covers or plates.
- H. All electrical raceways and enclosures shall be securely fastened in place.
- I. All electrical conductors shall be color-coded in a consistent manner. The grounded conductor and the equipment-grounding conductor shall be identifiable and distinguishable from all other conductors.
- J. All electrical circuits and equipment shall be grounded by means of either electrical circuit or system grounding or electrical equipment grounding in accordance with 29 CFR § 1910.304.
- K. All metal cable trays, metal raceways and metal enclosures for conductors shall be grounded.
- L. All metal enclosures for service equipment shall be grounded.
- M. The exposed non-current-carrying metal parts of fixed equipment that may become energized shall be grounded:
- If the equipment is subject to employee contact and within eight feet vertically or five feet horizontally of ground or grounded metal objects.
 - If the equipment is located in wet or damp environments.
 - If the equipment is in electrical contact with metal.
 - If the equipment is supplied current by a metal-clad, metal-sheathed or grounded metal raceway wiring method.
 - If the equipment operates with any terminal at over 150 volts to ground, with the following exceptions:
 - Enclosures for switches or circuit breakers used for other than service equipment and accessible to qualified persons only.

ELECTRICAL

(OSHA Operations)

- Metal frames of electrically heated appliances which are permanently and effectively insulated from ground.
 - The cases of distribution apparatus such as transformers and capacitors on wooden poles at a height of more than eight feet above ground or grade level.
- N. All non-current-carrying metal parts of equipment which are supplied current by a cord and plug shall be grounded, unless:
- The equipment is supplied through an isolating transformer with an ungrounded secondary of not more than 50 volts.
 - The portable tool is double insulated and distinctively marked accordingly.
- O. The metal parts of the following non-electric equipment shall be grounded:
- The frames and tracks of electrically powered/operated cranes,
 - Metal enclosures around equipment with over 750 volts between conductors.
- P. The equipment grounding conductor used to ground the non-current-carrying metal parts of equipment shall either be a conductor running with the power conductors within the same raceway, cable, or cord or shall be the metal conduit that encloses the power conductors
- Q. Electrical equipment, components and wiring methods shall conform to the standards of 29 CFR § 1910.305.
- R. Temporary wiring shall conform to the standards of 29 CFR § 1910.305.
- S. Flexible cables and cords shall not be used in lieu of fixed or permanent wiring, except for the following exceptions:
- Pendants.
 - Wiring of fixtures.
 - Connection of portable lamps or appliances.
 - Wiring of cranes and/or hoists where flexibility is necessary for operation.
 - Connection of stationary equipment which requires frequent interchange or moving.
 - Prevention of the transmission of vibration, where vibration tends to fatigue fixed wiring.
 - Appliances where the fastening means and mechanical connections are designed to facilitate removal for maintenance and/or repair, such as exhaust fans, water coolers, etc.
 - Data processing cables that are approved as a part of a data processing system.
 - Surge protection strips designed to protect data processing equipment.
- T. Where allowed for use, flexible cables and cords shall not:
- Run through holes in walls, ceilings, floors, etc.
 - Run through doorways, windows or similar openings.
 - Be attached to building surfaces with such devices as staples, nails, wire, etc.
 - Be concealed behind walls, ceilings, floors, etc.

ELECTRICAL **(OSHA Operations)**

- U. Standard National Electrical Manufacturer's Association (NEMA) plugs and receptacles shall be used on all cords and cables and shall be used jointly or separately as specified by NEMA specifications.
- V. All conductors and electrical equipment shall be protected from overcurrent.
- W. No electrical equipment, switches and wiring shall carry a load greater than that for which they are rated and as permitted by the National Electrical Code (NEC).
- X. Overcurrent protection of circuits and conducts shall not be modified beyond that allowed in the installation safety requirements for overcurrent protection, 29 CFR § 1910.304.e.
- Y. A disconnecting means (disconnect switch) shall be provided and located within sight of the controllers of all motors. The disconnecting means shall plainly indicate whether it is in the open (off) or closed (on) position. Disconnects for motor branch circuits exceeding 600 volts are not required in site of the controller; however, all installation using this exception shall conform to the standards of 29 CFR § 1910.305.
- Z. All motors, motor-control apparatus, and motor branch-circuit conductors shall be protected against overheating due to motor overloads or failure to start, against short-circuits and against ground faults.
- AA. All disconnect switches and overcurrent devices shall be legibly and permanently marked to indicate their purpose.
- BB. The energized parts of all motors and/or controllers operating at 50 volts or more between terminals shall be guarded to protect employees from accidental contact by one of the following methods:
 - Installed in a room or enclosure that is accessible only to qualified persons.
 - Installed on a balcony, gallery or other platform that is elevated and arranged to exclude unqualified persons.
 - Elevated eight feet or more above the floor.
- CC. The following requirements shall apply to transformers:
 - Warning signs shall be affixed to the equipment or structure and shall note the operating voltage of exposed energized parts of transformer installations.
 - Oil-insulated transformers that are installed indoors and that present a fire hazard, and dry-type, high fire point liquid-insulated and askarel-insulated transformers that are installed indoors and rated over 35kV, shall be installed in a vault designed to contain the fire and/or combustible liquids and to prevent unauthorized access.
 - Vault doors shall be designed to be opened from inside the vault.
 - Materials shall not be stored in transformer vaults.
 - Piping or duct systems shall not pass through or enter transformer vaults.
 - Safeguards shall be taken to eliminate the possibility of combustible materials, buildings, fire escapes and door and window openings from catching fire due to fires which may originate in oil-insulated transformers attached to or adjacent to the buildings or combustible materials.

ELECTRICAL (OSHA Operations)

- DD. Capacitors shall be equipped with an automatic discharge device or a device that will drain the capacitor's charge when the circuit is de-energized.
- EE. All safe work practices prescribed in 29 CFR § 1910.333 shall be followed by those persons performing work on or near electrical equipment. Personnel shall employ safety-related work practices to prevent electric shock and/or other injuries that may result from coming into direct or indirect contact with electrically energized components.
- FF. Employees having to work on or near energized electrical equipment/components/circuits shall de-energize the electrical equipment/components/circuits by following the procedures established for lockout/tagout. Refer to section on Lockout Tagout.
- GG. Only qualified persons shall be allowed to perform testing on electric circuits and/or equipment. Only qualified persons shall be allowed to work on electric circuits or equipment that have not been de-energized. This exception shall only apply to circuit/component testing that requires energization of the circuit/component.
- HH. Employees shall open disconnecting means (move disconnect switches to the off position) before fuses are replaced.
- II. Employees shall not work alone on energized lines or equipment over 600 volts.
- JJ. The cords and plugs of portable electric equipment and flexible cord sets (extension cords) including their receptacle and plug shall be visually inspected on every shift before use. Refer to section on Pre-operation Inspections.
- KK. The following tests shall be performed on all cord- and plug-connected equipment required to be grounded and on all cord sets and receptacles which are not a part of the permanent wiring of a building or structure:
- Equipment grounding conductors shall be tested for continuity and shall be electrically continuous.
 - Each receptacle and attachment cap or plug shall be tested for correct attachment of the equipment grounding conductor. The equipment grounding conductor shall be connected to its proper terminal.
- LL. These tests shall be performed:
- Before first initial use.
 - Before equipment is returned to service following any repairs.
 - Before equipment is used after any incident which can be reasonably suspected to have caused damage such as being run over by a vehicle.
 - At intervals not to exceed three months, except that cord sets and receptacles which are fixed and not exposed to damage shall be tested at intervals not exceeding six months.
- MM. Equipment that has not been tested as specified above shall not be used until such time as the equipment has been tested and shown to be safe.

ELECTRICAL (OSHA Operations)

- NN. The results of all performed tests shall be recorded and kept on file at each respective location. This test record shall identify each receptacle, cord set, and cord- and plug-connected equipment that passed the test. This record shall be kept by means of a log and a colored tape system. This record shall indicate the last date the equipment was tested and/or the interval for which it was tested and the color of the tape used for the respective cycle of testing. A different color tape shall be used for each successive cycle of testing (black tape is not an acceptable color). Refer to the "Electrical Equipment Test Documentation Form" (included in this section). All colored tape should be installed on the "male" end of extension cords. All colored tape from previous years should be removed before installing the new tape.
- OO. Cords and/or plugs that are found to be damaged (frayed or deteriorated insulation) and/or defective shall be removed from service until repaired. Flexible cords and cables shall be free of splices or taps. Cords and plugs that can not be repaired shall be destroyed and replaced.
- PP. Flexible cords shall not be fastened with staples, nails, etc. or otherwise hung in such a manner as to cause damage to the outer insulation of the cords.
- QQ. All flexible cords shall contain an equipment grounding conductor and appropriate plugs/receptacles to ensure proper continuity of the equipment grounding conductor at the point of attachment to fixed receptacles.
- RR. Ground-fault-circuit-interrupters (GFCIs) shall be installed on:
- Each temporary 15 or 20 ampere, 120 volt AC circuit at locations where construction, demolition, modifications, alterations or excavations are being performed.
 - All electrical circuits used in conjunction with portable electrical equipment and flexible power cords (extension cords).
 - All locations within close proximity to water, such as restroom and kitchen sinks, wash up stations in plants, etc.
- SS. The installation of ground-fault-circuit-interrupters (GFCIs) shall be progressively introduced at all operations and installation progress shall be monitored to ensure the timely installation of all required GFCIs.
- TT. All portable electrical equipment shall be protected by ground-fault-circuit-interrupters (GFCIs).
- UU. GFCIs shall be tested in accordance with the manufacturer's recommendations. Testing shall be documented and records maintained.
- VV. Portable electric equipment and flexible cords used in damp or wet work environments shall be approved for use in such environments.
- WW. Flammable materials that must be stored in small quantities shall be stored in properly labeled safety cans and in areas that are not within 25 feet of sources producing electric arcs.

ELECTRICAL (OSHA Operations)

- XX. Portable ladders shall be of non-conductive construction if they are used in areas where they can contact exposed electrically energized components.
- YY. Jewelry and/or clothing that are conductive (not protected or insulated) shall not be worn if they can contact exposed electrically energized components.
- ZZ. Employees working in areas where electrical hazards exist shall use appropriate personal protective equipment, as defined in section on Personal Protective Equipment.
- AAA. Personal protective equipment shall be maintained and periodically inspected/tested as outlined in section on Personal Protective Equipment.
- BBB. Employees working near exposed energized conductors or circuits shall use appropriate tools, including insulated tools, fuse pullers, non-conductive ropes, etc. Metal measuring tapes, ropes, handlines or similar devices with metallic thread woven into the fabric shall be prohibited.
- CCC. Safety signs, safety symbols and accident prevention tags shall be used where required to warn personnel of electrical hazards that may endanger them.
- DDD. Barricades shall be used in conjunction with safety signs where necessary to prevent or limit personnel access to work areas containing uninsulated energized conductors, components, etc.
- EEE. Attendants shall be used to warn personnel of electrical hazards if signs and barricades do not provide sufficient warning and protection.

1.4. Training

- A. Employees who perform work duties that may expose them to the risk of electric shock shall receive training to familiarize them with the safety-related work practices required by 29 CFR § 1910.331-.355 that pertain to their respective job duties.
- B. This classroom/on-the-job training shall address all aspects of the required job duties, emphasizing safety-related work practices and shall include the skills and techniques required to distinguish exposed energized parts from other parts of electric equipment, the skills and techniques required to determine the nominal voltage of exposed energized parts, the clearance distances specified in 29 CFR § 1910 and the corresponding voltages to which the qualified person will be exposed.
- C. The classroom portion of the training shall be completed as part of the company's "New Employee Safety Orientation Program."
- D. Electrical safety-related work practices shall be a periodic safety-training topic.

- 1.5. Monitoring and Enforcement** – The plant manager shall be responsible for implementation and enforcement of this policy. Failure to follow established procedures or failure to use proper personal protective equipment can result in an employee receiving a safety violation notice, loss of safety incentive, and/or disciplinary action up to and including termination of employment.

ELECTRICAL (OSHA Operations)

1.6. Record Keeping

- A. The plant manager or his designee shall maintain all records including inspection and training records.
- B. Training shall be documented by means of LEHIGH HANSON "Training Documentation Forms" and/or LEHIGH HANSON "Safety Meeting Forms" and a copy shall be placed in each employee's file (see section on Training). Training records shall be retained for a period of three years from the date of the training and shall include the following information:
 - Employee's name.
 - Date of training.
 - Outline describing the training material.
 - Signature of trainer documenting that training was provided.
 - Signature of employee documenting that training was received.

2. STATUTORY REFERENCES

- 2.1. 29 CFR § 1910.302 – Electric Utilization Systems.
- 2.2. 29 CFR § 1910.303 – General Requirements.
- 2.3. 29 CFR § 1910.304 – Wiring Design and Protection.
- 2.4. 29 CFR § 1910.305 – Wiring Methods, Components, and Equipment For General Use.
- 2.5. 29 CFR § 1910.306 – Specific Purpose Equipment and Installations.
- 2.6. 29 CFR § 1910.308 – Special Systems.
- 2.7. 29 CFR § 1910.332 – Training.
- 2.8. 29 CFR § 1910.333 – Selection and Use of Work Practices.
- 2.9. 29 CFR § 1910.334 – Use of Equipment.
- 2.10. 29 CFR § 1910.335 – Safeguards for Personnel Protection.
- 2.11. 29 CFR § 1926 Subpart K – Electrical.

Lehigh Hanson
HEIDELBERGCEMENT Group

Ladder Safety Policy
OSHA Operations

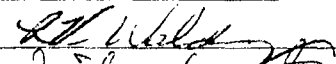
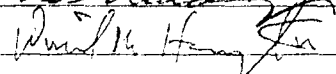
Effective Date	<u>March 1, 2011</u>		
Revision Date	<u></u>		
Approval	<u></u>	Date	<u>02/18/11</u>
Approval	<u></u>	Date	<u>02/18/11</u>

LADDER SAFETY (OSHA Operations)

1. CORPORATE POLICY, REQUIREMENTS AND PROCEDURES

1.1 Purpose – Proper use of ladders is essential to accident prevention. Even a good ladder can be a serious safety hazard when used by workers in an unsafe way. Falls from ladders often result in serious injury or death. The purpose of this program is to provide LEHIGH HANSON employees with guidance to safely use ladders.

1.2 Scope - This program is applicable to all LEHIGH HANSON employees who use portable ladders. This procedure does not apply to ladders that are an integral part of a structure or machinery.

1.3 Requirements

- A. Ladders shall be maintained in good condition at all times.
- B. Load limitations for ladders shall not be exceeded
- C. When working from a ladder, the ladder shall be securely placed, held, tied down, or otherwise made secure to prevent slipping or falling.
- D. All portable straight ladders shall be equipped with safety feet
- E. Ladders shall only be used in accordance with manufacturer's recommendations.
- F. Metal ladders shall not be used for any electrical work.
- G. All future ladder purchases shall be limited to Type 1A ladders.

1.4 Ladder Inspection

- A. Ladders on site shall be allocated a number which will be used on the periodic inspection sheet.
- B. Ladders shall be visually inspected before each use. Attachment A of this procedure contains a ladder inspection checklist that may be used as a guide for ladder evaluation.
- C. Broken or damaged ladders shall not be used. Most ladders cannot be repaired to manufacturer specifications. Broken or damaged ladders shall be immediately destroyed or tagged/properly disposed of.

Note: Only minor repairs shall be performed on ladders (e.g., replacement of safety feet, tighten loose hardware). Any other repairs shall require the ladder to be replaced.

- D. If a ladder is involved in any of the following, an immediate inspection shall be necessary prior to use/continued use to determine whether the ladder can be used, repaired or taken out of service.
 - If a ladder is dropped, or something falls on it, all rivets shall be inspected for shear, side rails shall be inspected for dents or bends, rungs shall be inspected for dents, and rung-to-side rail connectors shall be inspected for damage
 - If a ladder is exposed to fire or steam, an appropriate inspection must be performed.

LADDER SAFETY (OSHA Operations)

- If a ladder is subjected to acids and alkali solutions, an appropriate inspection must be performed.
- If a ladder comes in contact with oil or grease, it shall be cleaned of all slippery materials before being placed back into service.

1.5 Ladder Storage

- A. Ladders shall be stored in such a manner as to provide ease of inspection and use. Ladders shall be returned to and stored in designated storage areas after each use.
- B. Ladders when stored horizontally shall be supported at six foot intervals to prevent sagging of the middle section which can loosen the rungs and warp the rails.
- C. Ladders carried on vehicles shall be adequately supported and secured to minimize road shock damage and chafing.
- D. Ladders should be labeled and designated for specific plant areas.

1.6 Portable Ladder Ratings

- A. Portable Ladder Ratings (weight capacity not to be exceeded)

Type IA	Extra Heavy-Duty , for use such as utilities, contractors, industrial and construction job sites.	300 lbs.
Type I	Heavy-Duty , for use such as utilities, contractors, industrial and construction job sites.	250 lbs.
Type II	Medium-Duty , for use such as painters, offices, and light industrial; not acceptable on construction job sites.	225 lbs.
Type III	Light-Duty , household step ladder, 3 to 6 feet.	200 lbs.

Note: Ladders shall only be used in accordance with manufacturer's recommendations and all future ladder purchases shall be limited to Type 1A ladders.

- B. Limits on portable ladder length.
 - A stepladder shall be no more than 20 feet high.
 - A one-section ladder should be no more than 30 feet high.

1.7 Plant employees who use ladders shall be trained in the proper use of ladders.

1.8 Training

- A. The feet of the ladder shall be placed approximately one quarter of its supported length away from the vertical plane of its top support. (That is, set the ladder at a 4:1 slope.)
- B. The proximity of electrical conductors or other sources of electrical current must be checked when positioning ladders.

LADDER SAFETY (OSHA Operations)

- C. Only light, temporary work should be performed from ladders.
- D. Ladders shall not be placed in front of doors that open towards the ladder unless the door is locked or open and secured.
- E. When ascending or descending ladder workers are to face the ladder and use both hands, maintaining three point of contact at all times.
- F. If tools and materials are to be moved from one level to another, a rope, block and tackle, or other means shall be employed.
- G. Materials shall not be hand carried on ladders.
- H. Two people may not work from a single ladder.
- I. Ladders shall not be used horizontally as walkways or scaffolds.
- J. No job built ladders will be constructed or used.

1.9 Recordkeeping - None required

Exhibits

Exhibit A: Portable Ladder Inspection Checklist

2. STATUTORY REFERENCES

- 2.1** 29 CFR § 1910.25 Portable Wooden Ladders
Portable Metal Ladders
- 2.2** 30 CFR § 56.11011 Use of Ladders
- 2.3** 30 CFR § 56.11007 Wooden Ladders
- 2.4** 30 CFR § 56.11003 Construction & Maintenance
- 2.5** 30 CFR § 56.11004 Portable Rigid Ladders

FALL PROTECTION (OSHA Operations)

1. CORPORATE POLICY, REQUIREMENTS AND PROCEDURES

1.1. Purpose – To establish requirements for the use of fall protection devices and/or systems.

1.2. Definitions

- A. **Anchorage** – A secure point of attachment for lifelines, lanyards or deceleration devices.
- B. **Body Belt (Safety Belt)** – A strap with means for both securing it about the waist and for attaching it to a lanyard. (Not to be used by LEHIGH HANSON employees. Harnesses with waist D-rings will be used as positioning devices).
- C. **Body Harness** – Straps that may be secured about the employee in a manner that will distribute the fall arrest forces over the thighs, pelvis, waist, chest and shoulders with means for attaching it to other components of a personal fall arrest system.
- D. **Buckle** – The device used to hold the body harness securely around the employee's body.
- E. **Connector** – A device used to couple (connect) parts of the personal fall arrest system and positioning device system together. It may be an independent component of the system, such as a carabiner, or it may be an integral component or part of the system, such as a buckle or D-ring sewn into a body belt or body harness, or a snaphook spliced or sewn to a lanyard or self-retracting lanyard.
- F. **Cross Arm Strap Anchorage Point** – A strap that wraps around I-beam or other structure forming a secure attachment point for lanyards and other connecting devices.
- G. **Potentially Dangerous Equipment** – Machinery, electrical equipment and other units, which as a result of form or function, may be hazardous to employees who fall onto or into such equipment.
- H. **Deceleration Devices** – Any mechanism, such as rope grab, rip stitch lanyard, specially-woven lanyard, tearing or deforming lanyard, automatic self-retracting lifeline/lanyard, etc. which serves to dissipate a substantial amount energy during a fall arrest, or otherwise limits the energy imposed on an employee during fall arrest.
- I. **Deceleration Distance** – The additional vertical distance a falling person travels, excluding lifeline elongation and free fall distance, before stopping from the point at which the deceleration device begins to operate. It is measured as the distance a person's body harness attachment point travels during a fall. It is measured from the moment of activation of the deceleration device (at the onset of the fall arrest forces) until the person comes to a full stop.
- J. **D-Ring** – Forged steel rings that are used to attach connecting devices. D-rings shall have a minimum tensile load strength of 5,000 lbs.
- K. **Equivalent** – Alternative designs, materials or methods to protect against a hazard which will provide an equal or greater degree of safety for employees.

FALL PROTECTION

(OSHA Operations)

- L. Failure – Load refusal, breakage or separation of component parts. Load refusal is the point where the ultimate strength is exceeded.
- M. Free Fall – The act of falling before a personal fall arrest system begins to apply force to arrest the fall.
- N. Free Fall Distance – The vertical displacement of the fall arrest attachment point on the person's body harness between the onset of the fall and just before the system begins to apply force to arrest the fall. This distance excludes deceleration distance and lifeline/lanyard elongation, but includes any deceleration device slide distance or self-retracting lifeline/lanyard extension before they operate and fall arrest forces occur.
- O. Guardrail System – A barrier erected to prevent a person from falling to lower levels.
- P. Hoisting Area – A specific area of a structure where equipment, materials and/or tools are lifted from one level (floor or platform) to a higher level within a structure, or from the ground to an elevated floor or platform within a structure. When materials are not being lifted, guardrail systems guard these designated opening in floors or platforms. In order to facilitate the hoisting of equipment, materials and/or tools, portions of the guardrail system guarding these designated openings must be removed. The removal of these guardrail systems allows employees to receive or guide the hoisted items onto the receiving floor or platform.
- Q. Lanyard – A flexible line of rope, wire rope, or strap which generally has a connector at each end for connecting the body harness to a deceleration device, lifeline, or anchorage.
- R. Leading edge – The edge of a floor, roof, or formwork for a floor or other walking/working surface (such as the deck) which changes location as additional floor, roof, decking, or formwork sections are placed, formed, or constructed. A leading edge is considered to be an "unprotected side and edge" during periods when it is not actively and continuously under construction.
- S. Lifeline – A component consisting of a flexible line for connection to an anchorage point at one end to hang vertically (vertical lifeline), or for connection to an anchorage at both ends to stretch horizontally (horizontal lifelines). Horizontal lifelines serve as a means for connecting other components of a personal fall arrest system to the anchorage.
- T. Lower Levels – Areas of surfaces to which a person can fall. Such areas or surfaces include, but are not limited to ground levels, floors, platforms, pits, tanks, water, equipment, structures, etc.
- U. Personal Fall Arrest System – The system used to arrest a person in a fall from a working level. The three components of a fall arrest system are body harness, lanyard and connectors, and anchorage.
- V. Positioning Device System – The system used to keep a person positioned away from the fall area. The three components of a positioning device system are body harness, lanyard and connectors that are adjusted to the proper length, and anchorage.

FALL PROTECTION (OSHA Operations)

- W. Rope Grab – A deceleration device which is to be used with independent lifelines with a minimum tensile strength of 5,000 lbs. A short three to four inch lanyard is attached to the rope grab, which the user can move up or down the lifeline, yet will lock instantly when activated by a fall.
- X. Self-Retracting Lifeline/Lanyard – A deceleration device containing a drum-wound line, which under slight tension, can be slowly extracted from the drum or be retracted onto the drum. After the onset of a fall, the drum automatically locks and arrests the fall.
- Y. Snaphook – A connector comprised of a hook-shaped member with a normally closed keeper, or similar arrangement, which may be opened to permit the hook to receive an object. When released, the keeper automatically closes to retain the object. The only snaphook that shall be used is the locking type with a self-closing, self-locking keeper which remains closed and locked until unlocked and pressed open for connection or disconnection. Locking snaphooks shall have a minimum tensile load strength of 5,000 lbs.
- Z. Walking/Working Surface – Any surface, whether horizontal or vertical, on which a person walks or works, including but not limited to floors, roofs, etc. These surfaces do not include ladders, vehicles or trailers, on which a person must be located in order to perform their job duties.
- AA. Work Areas – That portion of a walking/working surface where job duties are being performed.

1.3. Requirements

- A. Scaffolds, ladders or vehicle mounted work platforms shall be used to provide a safe working surface whenever possible to reduce the hazard of falling. When these measures cannot provide safe access to the work being performed for any reason, an acceptable fall protection system shall be used.
- B. The use of 100 percent fall protection at the point of work, as well as going to and from the work area, is mandatory for all LEHIGH HANSON employees and all contractor personnel on LEHIGH HANSON projects, when employees are at risk of falling or working a minimum of four feet or more off the floor or ground, except in plant areas covered by 29 CFR § 1910.23, where the minimum distance off the floor or ground is four feet. Employees working on construction sites must use 100 percent fall protection when at risk of falling or working at a minimum of six feet or more off the ground. Fall arrest systems shall be rigged in such a manner that an employee can neither fall more than six feet nor contact any lower level.
- C. All fall protection components and/or systems used shall conform to the standards prescribed in 29 CFR § 1926.502.
- D. Types of fall protection systems available are:
 - Guardrail systems
 - Fall arrest systems.
 - Positioning device systems.
 - Safety netting.

FALL PROTECTION (OSHA Operations)

- E. The walking/working surfaces on which employees are to work must have the strength and structural integrity to support each employee safely.
- F. When employees are on walking/working surfaces near potentially dangerous equipment, each employee shall be protected from falling into or onto the dangerous equipment by a guardrail system or by equipment guards. Employees working above potentially dangerous equipment shall be protected from fall hazards by the use of guardrails or a positioning device system.
- G. When personnel are working or being hoisted in man lifts, bucket trucks, etc., each person shall be protected from the fall hazard by using a fall arrest system rigged in such a manner that the person can neither free fall more than six feet, nor contact any lower level. Traveling while being hoisted or held in a fixed position above a lower level is not recommended, and is only permitted on level paved surfaces at speeds of less than one mile per hour. Materials other than hand tools necessary for the specific elevated work shall not be transported with personnel.
- H. After fall arrest, equipment shall not be used again until inspected and determined by a competent person to be undamaged and suitable for reuse.
- I. Equipment should be stored in a cool, dry and clean environment that is out of direct sunlight. Protective bags can be used.

1.4. Training

- A. Employees required to use fall protection will be instructed in fall hazard recognition; proper fall protection system selection; and procedures for erecting, maintaining, disassembling and inspecting the fall protection systems to be used.
- B. Additional training shall be provided if:
 - Changes in the workplace take place that render previous training obsolete.
 - Changes in the types of fall protection systems or equipment used are made that render previous training obsolete.
 - Inadequacies in an affected employee's knowledge or use of fall protection systems or equipment are observed that indicate that the employee is not adequately trained.
- C. Fall protection will be a periodic safety-training topic.

- 1.5. **Monitoring and Enforcement** – The plant manager shall be responsible for implementation and enforcement of this policy. Failure to follow established fall protection procedures or failure to use proper personal protective equipment can result in an employee receiving a safety violation notice, loss of safety incentive, and/or disciplinary action up to and including termination of employment.

FALL PROTECTION (OSHA Operations)

1.6. Recordkeeping

- A. The plant manager or his designee shall maintain all records including inspection and training records.
- B. Training shall be documented by means of LEHIGH HANSON "Training Documentation Forms" and/or LEHIGH HANSON "Safety Meeting Forms" and a copy shall be placed in each employee's file (see Training section of this manual). Training records shall be retained for a period of three years from the date of the training and shall include the following information:
 - Employee's name.
 - Date of training.
 - Outline describing the training material.
 - Signature of trainer documenting that training was provided.
 - Signature of employee documenting that training was received.

2. COMPONENTS OF A FALL ARREST SYSTEM

2.1. Guardrail Systems

- A. Guardrails are the best method of fall protection available and are more acceptable than the use of a body harness for fall arrest or as a positioning device.
- B. Guardrail systems shall be so surfaced as to prevent injury to an employee from punctures or lacerations, and to prevent snagging of clothing.
- C. When guardrail systems are used at hoisting areas, a chain, inwardly opening gate or removable guardrail section shall be placed across the access opening between the guardrail sections when hoisting operations are not taking place.
- D. When guardrail systems are used around openings that are used as points of access, such as ladder ways, etc., they shall be provided with an inwardly opening gate or be offset so that a person cannot walk directly into the opening.

2.2. Body Harness

- A. The body harness is the first of the three components that make-up a fall arrest system. Only a full body harness shall be used when there is a possibility that a worker could fall from an elevated level to a lower level. Full body harnesses distribute the forces of a fall throughout the worker's body among the shoulders, legs, torso and buttocks. This distribution decreases the likelihood that the worker will be injured.
- B. Fall protection devices should only be attached to the D-ring, located in the center of the wearer's back near shoulder level. Other D-rings, especially side and front rings, should only be used for positioning.
- C. When using full body harnesses, employees shall use the straps and buckles to adjust the harness to ensure a snug fit.

FALL PROTECTION (OSHA Operations)

- D. Full body harnesses should never be used to hoist or lift materials.
- E. Body harnesses involved in a fall shall be taken out of service and destroyed.

2.3. Connecting Devices

- A. Connecting devices are the second of three components that make-up a fall arrest system. These devices are used to attach the body-wear to the point of anchorage. The most common types of connecting devices are rope, webbing, steel or shock absorbing lanyards, but may also be retractable lifelines, rope grabs, etc.
- B. Only shock-absorbing lanyards or lanyards attached to a shock absorbing pack should be part of the fall arrest system.
- C. Lanyards and lifelines shall have a minimum breaking strength of 5,000 lbs., and shall be equipped with locking snap-hooks. The use of knots to connect lanyards is not permitted.
- D. Straps (webbing) used in lanyards and lifelines shall be made from synthetic fiber and shall be protected against being cut or abraded, and shall not pass over sharp edges without padding or "softeners."
- E. Steel lanyards shall never be used.
- F. Self-retracting lifelines and lanyards, which automatically limit free fall distance to two feet or less, shall be capable of sustaining a minimum tensile load of 3,000 lbs. applied to the device with the lifeline or lanyard in the fully extended position.
- G. Self-retracting lifelines and lanyards which do not limit free fall distance to two feet or less, must have rip-stitch lanyards and tearing lanyards capable of sustaining a minimum tensile load of 5,000 lbs. applied to the device with the lifeline or lanyard fully extended.
- H. When using rope as part of a fall arrest system, environmental exposure should be considered. Factors affecting this decision are:
 - Polyester rope has good resistance to mild acidic conditions.
 - Polypropylene rope has good resistance to chemicals, but has a lower breaking strength.
 - Nylon rope should be protected from paint and chemicals. Nylon ropes may not be used in or near chlorine or chlorinated water due to the adverse chemical reaction.
- I. Well-maintained ropes have a service life of one to two years, and webbings have a service life of two to three years. Both have a five year shelf life and shall be marked so their age can be accurately determined.

FALL PROTECTION

(OSHA Operations)

2.4. Anchoring Devices

- A. The anchoring device is the third of the three components that make-up a fall arrest system. Selecting proper anchorage points and anchoring devices is one of the most important factors to be considered when completing a fall protection system.
- B. All anchorage points shall be capable of supporting 5,000 lbs. per attached worker and shall be approved by management prior to attachment. Examples of acceptable anchorage points are structural beams with padding, eyebolts, etc.
- C. Anchorage points should be easily accessible and, if possible, should be directly above the worker to limit the free fall distance. Avoid tying off to an anchor at foot level, since this increases the fall distance allowed by the connecting device.
- D. A cross arm strap anchorage point may be used to attach fall protection system to I-beams and other structures that do not have a hole to attach a lanyard or lifeline to.
- E. The lanyard or lifeline locking snaphook shall be hooked so that it will close completely. Never put the open hook on a beam flange. When connecting to a beam, it is acceptable to lock the snaphook in a hole in the flange of the beam.
- F. Locking snaphooks shall be sized to be compatible with the structural member to which they are being connected in order to prevent unintentional disengagement.

2.5. Fall Arrest System

- A. Individually, none of the three components that make-up a fall arrest system (body harness, connecting devices and anchoring devices) will provide protection from a fall. Used properly with each other, they form a complete system and become an important part of the total fall protection system.
- B. It is essential not to mix and match components from several different manufacturers, since this can create a problem with compatibility of the components and not provide the required level of protection.
- C. Personal fall protection systems shall be inspected prior to each use for wear, damage and other deterioration. Defective components shall be removed from service.
- D. When stopping a fall, the personal fall arrest system used with a body harness shall be rigged to limit the maximum arresting force on an employee to 1,800 lbs., while ensuring that an employee will neither free fall more than six feet nor contact any lower level.
- E. The fall arrest system shall never be attached to guardrails and handrails, since these are not designed to withstand the forces generated in a fall.
- F. Impacted components of a fall arrest system shall be removed from service and not used again until a qualified person inspects them and finds them to be free of defects.

FALL PROTECTION

(OSHA Operations)

- G. Note: To meet the strength and design requirements of the fall arrest system, components of the system must meet the requirements of ANSI-Z-359.1-2007 standards.

2.6. Positioning Devices

- A. Full body harnesses shall be used to restrain a worker in a hazardous position and reduce the possibility of a fall.
- B. The lanyard attached to the harness shall have the length adjusted to keep the worker positioned only as far as the edge of the walking/working surface and the worker shall be at zero free fall distance.
- C. Connecting devices that are of a decelerating type (rope grab, ripstitch lanyards, specially woven lanyards, tearing or deforming lanyards, automatic self-retracting lifelines/lanyards, etc.) shall not be used as a part of the positioning system because of the additional distances these devices allow one to fall after they are activated by the fall.
- D. Positioning devices shall be rigged such that an employee cannot free fall more than two feet.

2.7. Leading Edges

- A. Each employee who is constructing a leading edge six feet or more above a lower level shall be protected from falling by guardrail systems, personal fall arrest systems or safety net systems.
- B. Each employee on a walking/working surface six feet or more above a lower level where leading edges are under construction, but who is not engaged in the leading edge work, shall be protected from falling by a guardrail system, personal fall arrest system or safety net system.
- C. In circumstances where it is infeasible to use guardrail systems, personal fall arrest systems, or safety net systems or where the use of these systems creates a greater hazard, LEHIGH HANSON shall develop and implement a fall protection plan that meets the following requirements.
 - The plan shall be prepared by a qualified person and developed specifically for the site where the leading edge work is being performed.
 - A qualified person shall approve any changes to the plan.
 - A copy of the plan, including all approved changes shall be maintained up to date and at the job site.
 - The implementation of the plan shall be under the supervision of a competent person.

FALL PROTECTION (OSHA Operations)

- The plan shall document the reasons why the uses of guardrail systems, personal fall arrest systems, or safety net systems are infeasible or why their use would create a greater hazard.
 - The plan shall include a written discussion of other measures that will be taken to reduce or eliminate the fall hazard for workers who cannot be provided with protection from guardrail systems, personal fall arrest systems, or safety net systems. This discussion may include the extent to which scaffolds, ladders, or vehicle mounted work platforms can be used to provide a safer working surface and thereby reduce the hazard of falling.
 - The plan shall identify each location where guardrail systems, personal fall arrest systems, or safety net systems cannot be used. These locations shall be classified as controlled access zones.
 - The plan shall include a statement that provides the name or other method of identification for each employee who is designated to work in the controlled access zones. No other employees shall be allowed to enter the controlled access zones.
- D. In areas where no other alternative measure has been implemented, LEHIGH HANSON shall implement a safety monitoring system.
- E. In the event an employee falls or a near miss occurs, LEHIGH HANSON shall investigate the circumstances of the fall or near miss. This investigation shall be completed to determine if the fall protection plan needs to be changed to include new practices, procedures, or training. LEHIGH HANSON shall implement required changes to prevent similar types of falls or incidents.
- F. Controlled access zones and their use shall conform to the following requirements.
- The controlled access zones shall be defined by a control line or by any other means that restricts access.
 - The control lines shall be erected not less than six feet nor more than 25 feet from the unprotected or leading edge, except when erecting precast concrete members. When erecting precast concrete members, the control line shall be erected not less than six feet nor more than 60 feet or half the length of the member being erected, whichever is less, from the leading edge.
 - The control line shall extend along the entire length of the unprotected or leading edge and shall be approximately parallel to the unprotected or leading edge.
 - The control line shall be connected on each side to a guardrail system or wall.
 - Control lines shall consist of ropes, wires, tapes, or equivalent materials. Control lines shall be supported in the following manner.
 - Each line shall be flagged or otherwise clearly marked at not more than six foot intervals with high-visibility material.

FALL PROTECTION (OSHA Operations)

- Each line shall be rigged and supported in such a way that its lowest point (including sag) is not less than 39 inches from the walking/working surface and its highest point is not more than 45 inches from the walking/working surface.
 - Each line shall have a minimum breaking strength of 200 pounds.
- G. Safety monitoring systems and their use shall conform to the following requirements.
- LEHIGH HANSON shall designate a competent person to monitor the safety of other employees and LEHIGH HANSON shall ensure that the safety monitor complies with the following requirements.
 - The safety monitor shall be competent to recognize fall hazards.
 - The safety monitor shall warn an employee when it appears that the employee is unaware of a fall hazard or is acting in an unsafe manner.
 - The safety monitor shall be on the same walking/working surface and within visual sighting distance of the employee being monitored.
 - The safety monitor shall be close enough to communicate orally with the employee being monitored.
 - The safety monitor shall not have other responsibilities that could take the monitor's attention from the monitoring function.
 - Mechanical equipment shall not be used or stored in areas where safety-monitoring systems are being used to monitor employees engaged in roofing operations on low-slope roofs.
 - No employee, other than an employee engaged in roofing work on a low-sloped roof or an employee covered by a fall protection plan, shall be allowed in an area where an employee is being protected by a safety monitoring system.
 - Each employee working in a controlled access zone shall be directed to comply promptly with fall hazard warnings from safety monitors.

2.8. Inspections

- A. Before using any fall protection device, each employee shall personally make a visual inspection to determine that no parts of the device are damaged or defective. Defective components shall be removed from service. Formal inspections should be performed annually by a competent person. Annual inspections should be recorded in a centralized log book that includes serial number, date of purchase, dates of inspection, servicing performed and authorized signatures.
- B. Before using any of the following devices, the following checks should be performed:
- Check **straps** for frayed edges, broken fiber, pulled stitches, cuts or chemical damage.
 - Check **D-rings and D-ring metal wear pads** for distortion, cracks, breaks, and rough or sharp edges. The D-ring bar should be at a 90 degree angle with the long axis of the belt and should pivot freely.

FALL PROTECTION (OSHA Operations)

- Check **buckles** to ensure tongues are free of distortion in shape and motion. Look for loose, broken or distorted grommets. Straps should not have additional punched holes. Rivets should be tight and not removable with fingers. Bent rivets will fail under stress.
- Check **friction buckles** for distortion. The outer bar or center bar must be straight.
- Check **snaphooks** to ensure there is no hook or eye distortion, cracks, corrosion or pitted surfaces. The keeper or latch of the hook should seat into the nose without binding and should not be obstructed. The force of the spring should adequately close the keeper. The hook must remain closed when locked.
- Check **thimbles** (the protective plastic sleeve spliced into ropes) to ensure they are firmly seated into the eye of the splice, and that the splice has no loose or cut strands.
- Check **web lanyards** for swelling, discoloration, cracks or breaks in the stitching. Do not use a web lanyard as part of the fall arrest system without a shock-absorbing device.
- Check **rope lanyards** for fuzzy, worn, broken or cut fibers. The rope diameter should be constant throughout the length of the lanyard. Changes in diameter may indicate a weakened area due to overloading. Do not use a rope lanyard as part of the fall arrest system without a shock-absorbing device.
- Check **shock absorbing packs** for burn holes or tears. Check the stitching on areas where the pack is sewn to the D-ring, belt, or lanyard for loose strands, rips or deterioration.

3. STATUTORY REFERENCES

3.1. 29 CFR § 1926 Subpart M – Fall Protection.

3.2. 29 CFR §1910.66 and §1926.502

LOCKOUT TAGOUT (OSHA Operations)

1. CORPORATE POLICY, REQUIREMENTS AND PROCEDURES

1.1. Purpose – To establish requirements and procedures to prevent the unintended release of energy – electrical, potential, gravity, hydraulic, pneumatic, etc. – which may energize an electrical circuit or a machine or cause a machine or machine part to unexpectedly move or fall, causing injury to any employee.

1.2. Definitions

- A. **Affected Employee** – An employee whose job requires him/her to operate or use a machine or equipment on which servicing or maintenance is being performed under lockout or tagout, or whose job requires him/her to work in an area in which such servicing or maintenance is being performed.
- B. **Authorized Employee** – A person who locks out or tags out machines or equipment in order to perform servicing or maintenance on that machine or equipment. An affected employee becomes an authorized employee when that employee's duties include performing servicing or maintenance covered under this section.
- C. **Energy Isolation Device** – A mechanical device that physically prevents the transmission or release of energy, including but not limited to a manually operated electrical circuit breaker; a disconnect switch; a line valve; or a block, a chock or cribbing used to block or isolate energy.
- D. **Lockout** – The placement of a lockout device, such as a keyed lock, on an energy isolating device, in accordance with an established procedure, ensuring that the energy isolating device and the equipment being controlled cannot be operated until the lockout device is removed.
- E. **Lockout Device** – A device that utilizes a positive means such as a lock, either key or combination type, to hold an energy isolating device in the safe position and prevent the energizing of a machine or equipment. Included are blank flanges and bolted slip blinds.
- F. **Servicing and/or Maintenance** – Workplace activities such as constructing, installing, setting up, adjusting, inspecting, modifying, and maintaining and/or servicing machines or equipment. These activities include lubrication, cleaning or unjamming of machines or equipment and making adjustments or tool changes, where the employee may be exposed to the unexpected energization or startup of the equipment or release of hazardous energy.
- G. **Tagout** – The placement of a tag, in conjunction with a lockout device, on an energy isolating device, in accordance with an established procedure, to indicate the owner of the lockout device.
- H. **Tagout Device** – A prominent warning device, such as a tag and a means of attachment, which can be securely fastened to an energy isolating device in accordance with an established procedure, to indicate that the energy

LOCKOUT TAGOUT (OSHA Operations)

isolating device and the equipment being controlled may not be operated until the tagout device is removed.

1.3. Requirements

- A. LEHIGH HANSON shall make locks and tags available to all LEHIGH HANSON employees who might perform servicing and/or maintenance operations on machinery and/or equipment.
- B. Each person performing servicing and/or maintenance work on machinery and/or equipment shall apply his/her own lock and tag. The key to the lock shall be kept with them while they are performing the work on the machinery and/or equipment.
- C. Only one key shall be allowed for any locks used in the lockout tagout procedure. Master-keyed locks or match-keyed locks shall not be used in the procedure.
- D. No employee or contractor shall attempt to operate a switch, valve or other energy isolating device bearing a lock.
- E. A survey of each LEHIGH HANSON operation shall be conducted to identify the energy hazards that exist and where they are located. Specific energy control procedures (lockout/tagout procedures) shall be developed for each piece of equipment or machinery. (Refer to the sample of these procedures provided in this section. This sample and the accompanying blank form shall be used to develop and document site specific procedures for each machine or piece of equipment requiring an energy control procedure.) An alternative procedure format may be used upon approval of the Safety Department.
- F. The energy control procedures shall outline the scope, purpose, authorization, rules and techniques to be utilized for the control of hazardous energy, and the means to enforce compliance including but not limited to, the following:
 - A specific statement of the intended use of the procedure.
 - Specific procedural steps for shutting down, isolating, blocking and securing a machine or a piece of equipment to control hazardous energy.
 - Specific procedural steps for the placement, removal and transfer of lockout devices or tagout devices and the responsibility for them.
 - Specific requirements for testing a machine or a piece of equipment to determine and verify the effectiveness of lockout devices, tagout devices and other energy control measures.
- G. Energy control procedures need not be documented for a particular machine or piece of equipment when all of the following exist:

LOCKOUT TAGOUT (OSHA Operations)

- The machine or piece of equipment has no potential for stored or residual energy or reaccumulation of stored energy after shut down which could endanger employees.
 - The machine or piece of equipment has a single energy source, which can be readily identified and isolated.
 - The isolation and locking out of that single energy source will completely deenergize and deactivate the machine or piece of equipment.
 - The machine or piece of equipment is isolated from that single energy source and locked out during servicing or maintenance.
 - A single lockout device will achieve a locked-out condition.
 - The lockout device is under the exclusive control of the authorized employee performing the servicing or maintenance.
 - The servicing or maintenance does not create hazards for other employees.
 - The employer, in utilizing this exception, has had no accidents involving the unexpected activation or reenergization of the machine or equipment during servicing or maintenance.
- H. Energy control procedures shall be utilized for the control of potentially hazardous energy when employees are engaged in performing any servicing and/or maintenance work on powered machinery or equipment. If work is being performed on portable power tools, they should be physically disconnected from the energy source in preparation for the work.
- I. No person shall perform any servicing and/or maintenance work on powered machinery or equipment until all power sources have been de-energized and locked-out and tagged-out. This shall be accomplished by adhering to the following lockout tagout procedure:
- Only authorized employees shall lockout or tagout machines or equipment in order to perform servicing or maintenance on that machine or equipment.
 - All employees affected by the de-energizing of the equipment shall be notified of the application and removal of lockout/tagout devices. Notification shall be given before the controls are applied, and after they are removed from the machine or piece of equipment.
 - The type and source of energy/power needing to be de-energized and/or controlled shall be determined.
 - The equipment shall be shutdown by normal shut down procedures.

LOCKOUT TAGOUT (OSHA Operations)

- The power/energy source shall be de-energized or controlled by either “throwing” the respective power switch(es) or by removing the ignition key and/or battery leads.
 - Personnel energizing or de-energizing the power source by “throwing” the respective power switch shall stand to the side of the switchgear and look away to avoid possible injury in the event that the switchgear would explode.
 - The energy isolating devices shall be locked-out/tagged-out with individual locks and tags. **Note:** Combination locks are prohibited for use in any lockout procedure for all machines and equipment. Tags shall state “**Do Not Operate**” and shall identify the owner of the tag and associated lock.
 - The equipment shall be tested to ensure the energy/power source has been isolated. After ensuring that no personnel are exposed, check to ensure that energy sources are disconnected by operating the normal controls to make certain the equipment will not operate or move.
 - Return operating controls to the "neutral" or "off" position after the test.
 - The equipment is now locked-out and tagged-out and maintenance/repair operations can begin.
- J. No person shall perform any servicing and/or maintenance work on powered machinery or equipment until all energy sources have been isolated, locked-out and tagged-out by them personally to prevent the unintended release of energy – electrical, potential, gravity, etc., which may cause the machine or machine part to unexpectedly move or fall.
- This shall be accomplished by the lockout tagout procedure described above. Additionally, stored energy shall be dissipated or restrained by methods such as repositioning, blocking, bleeding down, etc.
- K. Whenever outside servicing and/or maintenance contractors are to be engaged in activities covered by the scope and application of energy control procedures covered in this section:
- LEHIGH HANSON and the outside contractor shall inform each other of their respective procedures.
 - LEHIGH HANSON shall ensure that his/her employees understand and comply with the restrictions and prohibitions of the outside contractor's energy control program.
- L. Upon completion of their assigned servicing and/or maintenance work and when they are no longer exposed to hazards which could result from an uncontrolled release of energy, individuals shall remove their own locks and tags.

LOCKOUT TAGOUT (OSHA Operations)

- M. Failure of an individual to remove his/her own lock and tag upon the completion of their assigned tasks, can result in the affected machinery or piece of equipment not being placed back into service in a timely and efficient manner. However, in emergency situations where the person who installed a lock and tag failed to remove their lock and tag and are unavailable, the following procedure shall be followed:
- Upon determining that all persons are removed from the affected area of the machinery or piece of equipment and that the maintenance/repair work has been completed, the plant manager can remove the lock and tag.
 - If the plant manager is not present at the site, the supervisor who is in charge shall contact the plant manager and obtain verbal approval to remove the lock and tag. Upon receipt of verbal approval, the lock and tag shall only be removed after determining that all persons are removed from the affected area of the machinery or piece of equipment and that the maintenance/repair work has been completed.
 - The following procedure shall be followed when restoring power/energy to machinery or a piece of equipment:
 - Upon completion of maintenance/repair operations and the equipment is ready for normal production operations, all guards shall be re-installed and all tools shall be removed from the machinery or piece of equipment.
 - The area shall be checked to ensure that all other employees have left the affected area of the machinery or piece of equipment, that no one will be exposed to a hazard which could result from an uncontrolled release of energy and that all locks and tags have been removed from the isolation devices.
 - The energy isolating devices shall be operated to restore energy to the machine or piece of equipment.

1.4. Training

- A. Authorized employees will be instructed in the recognition of applicable hazardous energy sources, the type and magnitude of the various energy sources found in the workplace, the acceptable lockout tagout procedures necessary for energy isolation and control, procedures for removing locks and tags and procedures for restoring energy.
- B. Affected employee shall be instructed in the purpose and use of the energy control procedures. All other employees whose work operations are or may be in an area where energy control procedures may be utilized, shall be instructed about the procedure and about the prohibition relating to attempts to restart or re-energize machines or equipment which are locked out or tagged out.

LOCKOUT TAGOUT (OSHA Operations)

- C. Retraining will be provided when there is a change in job assignment, a change in equipment or processes that would create a new hazard or a change would occur in the company's lockout tagout policy.
- D. Lockout Tagout will be a periodic safety-training topic.

1.5. Monitoring and Enforcement – The plant manager, his designee and other LEHIGH HANSON managers, when present, shall be responsible for implementation and enforcement of this policy. Failure to follow established lockout tagout procedures shall result in an employee receiving a safety violation notice, loss of safety incentive and/or disciplinary action up to and including termination of employment.

- A. **Any person who removes the lock of another person without proper authorization shall be immediately suspended, with the potential for subsequent discharge.**
- B. **Failure by any person to lockout and tagout machinery or a piece of equipment, prior to performing maintenance/repair operations, shall be immediately suspended, with the potential for subsequent discharge.**

1.6. Recordkeeping

- A. The plant manager or his designee shall maintain all records including energy control procedures, annual inspections and training records.
- B. Training shall be documented by means of LEHIGH HANSON "Training Documentation Forms" and/or LEHIGH HANSON "Safety Meeting Forms" and a copy shall be placed in each employee's file (see Training section of this manual). Training records shall be retained for a period of three years from the date of the training and shall include the following information:
 - Employee's name.
 - Date of training.
 - Outline describing the training material.
 - Signature of trainer documenting that training was provided.
 - Signature of employee documenting that training was received.

1.7. Annual Review and Inspection

- A. The Lockout Tagout Policy annual plan review shall include an inspection of all energy control procedures to ensure that the procedure and all regulatory and company requirements are being followed.
- B. The plant manager and respective Safety Department shall be responsible for ensuring that the inspections are completed annually, for ensuring that the energy control procedures are updated in accordance with the findings of the inspections and for documenting/certifying the completion of the review process. All completed reviews shall be documented/certified by completing

LOCKOUT TAGOUT (OSHA Operations)

the form entitled "Lockout Tagout Inspection Checklist," included in this section.

- The certification shall identify the machine or equipment on which the energy control procedure was being utilized, the date of the inspection, the employees included in the inspection and the person performing the inspection.
- An authorized employee other than the one(s) utilizing the energy control procedure being inspected shall perform the periodic inspection.
- The periodic inspection shall be conducted to correct any deviations or inadequacies identified.
- The annual inspection shall include a review, between the inspector and each authorized employee, of that employee's responsibilities under the energy control procedure being inspected.
- In isolated cases, where lockout is not possible and only tagout is used for energy control, the annual inspection shall include a review, between the inspector and each authorized and affected employee, of that employee's responsibilities under the energy control procedure being inspected, and the limitation of tags.
- Employees found to be in violation of the lockout procedures will be retrained and shall be subject to disciplinary procedures.

2. STATUTORY REFERENCES

2.1. 29 CFR § 1910.147 – The control of hazardous energy (lockout/tagout).

2.2. 29 CFR § 1910.333 – Selection and use of electrical work practices.

LOCKOUT TAGOUT (OSHA Operations)

ENERGY SOURCE PROCEDURES (Included in this Section)

1. MAIN AGGREGATE HOPPER
2. MAIN AGGREGATE HOPPER SUMP PUMP
3. MAIN AGGREGATE CONVEYOR, TRANSFER CHUTE AND CAST AGGREGATE CONVEYOR
4. MACHINE PLANT ROTARY TURNCHUTE
5. CAST PLANT ROTARY TURNCHUTE
6. MACHINE PLANT BATCH TOWER
7. CAST PLANT BATCH TOWER
8. MACHINE PLANT SILO BAGHOUSE
9. CAST PLANT SILO BAGHOUSE
10. MACHINE PLANT SILO BUTTERFLY VALVE AND SCREW CONVEYOR
11. CAST YARD SILO BUTTERFLY VALVE AND SCREW CONVEYOR
12. MACHINE PLANT WEIGH HOPPER CLAMNET
13. CAST PLANT WEIGH HOPPER CLAMNET
14. MACHINE PLANT AGGREGATE HOPPER FLOP-CHUTE
15. CAST PLANT AGGREGATE REVERSING CONVEYOR
16. MACHINE PLANT MIXER BAGHOUSE
17. CAST PLANT MIXER BAGHOUSE
18. PH 60 MIXER
19. PH 84 MIXER
20. CAST PLANT MIXER
21. PH 60 MIXER CONVEYOR
22. PH 84 MIXER CONVEYOR
23. PH 60 PIPE MACHINE
24. PH 84 PIPE MACHINE
25. RADIAL STACKER AND PH 84 MUDHOPPER CONVEYOR
26. PH 84 PIT CONVEYOR
27. PH 84 WASTE CONVEYOR
28. DRY CAST MATERIAL CONVEYOR
29. DRY CAST MUDHOPPER CONVEYOR
30. DRY CAST RADIAL CONVEYOR
31. ROBBINS & MEYERS 7½ TON BRIDGE CRANE
32. DRESSER 25-TON BRIDGE CRANE
33. YORK-SHIPLEY BOILER
34. PH 60 MOVING FLOOR AND CURING SYSTEM
35. PH 84 STEAM CURING SYSTEMS
36. OUTSIDE CURING STATIONS
37. WIRE ROLLER MACHINES
38. HYDRAULIC BENDER
39. WELDING EXHAUST FANS

LOCKOUT TAGOUT (OSHA Operations)

HCP ENERGY CONTROL PROCEDURE ***Hanover Pipe Plant***

Machine Name: Main Aggregate Hopper Location: Raw Material Receiving Area

SPECIAL NOTES: THE BALL-VALVE LOCKOUT FOR THE AIR OPERATED HOPPER VIBRATOR AND CLAMGATE IS LOCATED BEHIND THE PH84 MIXER ON THE NORTH/CENTRAL WALL OF THE MACHINE PLANT. WORK THAT REQUIRES ENTRY INTO THE MAIN AGGREGATE HOPPER WILL CONFORM WITH HCP CONFINED SPACE ENTRY PROCEDURES. ALL GUARDING MUST BE IN PLACE WHEN EQUIPMENT IS IN OPERATION. GUARDS MAY NOT BE REMOVED OR BY-PASSED WITHOUT PROPER LOCK-OUT/TAG-OUT PROCEDURES.

ENERGY SOURCES APPLICABLE TO THIS EQUIPMENT

ELECTRICAL HYDRAULIC MECHANICAL THERMAL PNEUMATIC
STEAM WATER ELEVATED MACHINE MEMBERS SPRINGS
COMPRESSED GAS RADIO FREQUENCY OTHER : Block feed access

LOCKOUT/TAGOUT PROCEDURE – NOTIFY ALL AFFECTED INDIVIDUALS AND PROCEED AS FOLLOWS. NOTIFY MANAGEMENT IN THE EVENT OF ANY ABNORMAL SITUATION

1. SHUT OFF HOPPER VIBRATOR/CLAMGATE AND WAIT UNTIL *ALL COMPONENTS ARE COMPLETELY STOPPED*.
2. SHUT OFF THE MAIN AGGREGATE CONVEYOR DISCONNECT. BLOCK OR CHAIN ANY PORTIONS OF THE MACHINE WHERE REQUIRED. BLEED OFF ANY PNEUMATIC PRESSURE IN LINES.
3. LOCK AND TAGOUT THE PNEUMATIC (AIR) BALL VALVE AND MAIN AGGREGATE DISCONNECT. *TEST ALL CONTROLS PRIOR TO BEGINNING WORK.*
4. MACHINE IS NOW SAFE, PROCEED WITH REPAIR OR ADJUSTMENT.
5. COMPLETE TASK, DOUBLE CHECK REPAIR WORK OR MACHINE ADJUSTMENT.
6. CLEAR AREA OF TOOLS AND EQUIPMENT, NOTIFY ALL AFFECTED EMPLOYEES OF IMPENDING RESTART OF MACHINE OR EQUIPMENT.
7. REMOVE LOCKOUT-TAGOUT DEVICES.
8. PROCEED WITH RESTART OF MACHINE OR EQUIPMENT.

ENERGY CONTROL DEVICES NEEDED:

LOCK(S) TAG(S) HASP(S) PLUG COVER BOX
CHAIN BLOCK PIN OTHER(S) : _____

FIRE SAFETY (OSHA Operations)

1. CORPORATE POLICY, REQUIREMENTS AND PROCEDURES

1.1. Purpose – To establish requirements for the use and maintenance of fire fighting equipment.

1.2. Definitions

- A. Combustible material – A material that, in the form in which it is used and under the conditions anticipated, will ignite, burn, support combustion, or release flammable vapors when subjected to fire or heat. Wood, paper, rubber and plastics are examples of combustible materials.
- B. Flammable gas – A gas that will burn in the normal concentrations of oxygen in the air.
- C. Flammable liquid – A liquid that has a flash point below 100 °F (37.8 °C), a vapor pressure not exceeding 40 pounds per square inch (absolute) at 100 °F (37.8 °C).
- D. Flash point – The minimum temperature at which sufficient vapor is released by a liquid to form a flammable vapor-air mixture near the surface of the liquid.
- E. Multipurpose dry-chemical fire extinguisher – An appropriate extinguisher containing a dry-chemical agent.
- F. Safety can – A container of not more than five gallons capacity that is designed to safely relieve internal pressure when exposed to heat and has a spring-closing lid and spout cover.
- G. Storage tank – A container exceeding 60 gallons in capacity used for the storage of flammable or combustible liquids.

1.3. Requirements

- A. All employees shall be responsible for following established fire prevention and fire extinguisher guidelines.
- B. All employees shall be responsible for following established oxyacetylene cutting and electric arc welding guidelines.
- C. All employees shall be responsible for following established housekeeping and chemical handling guidelines.

1.4. Fire Prevention Policy and Procedures

- A. Fire Prevention
 - It is the responsibility of all employees to prevent any type of fire on the premises. Listed below are general guidelines to take into consideration to accomplish this objective:
 - Extinguish all cigarettes in their proper place.

FIRE SAFETY (OSHA Operations)

- Do not put any type of hot object in trashcans; i.e., cigarette butts, etc.
- Make sure all hand held torches are extinguished when not in use.
- Have a fire extinguisher(s) in close proximity to all areas in which welding and cutting operations are done.
- Do not have open flame around flammable substances.
- Heat detection devices and/or smoke detection devices should be installed in Motor Control Centers.

B. Fire Extinguishers

- All fire extinguishers shall be maintained in the following manner:
 - Designated personnel will conduct monthly inspections of all fire extinguishers. Any questions or problems should be directed to their supervisor for immediate action.
 - An outside extinguisher firm or other competent person will conduct annual checks on all fire extinguishers.
 - Monthly inspections should be noted and initialed by the inspector on a rigid/weatherproof tag attached to each extinguisher and/or on a log located in the plant office.
- Fire extinguishers shall be recharged or replaced with a fully charged extinguisher immediately after the fire in question has been extinguished.
- An appropriate 5-lb or greater multipurpose, dry-chemical fire extinguisher shall be mounted on all self-propelled equipment. The extinguisher shall be mounted by means of a bracket, except where an automatic fire suppression system is installed.

C. Oxyacetylene Cutting and Electric Arc Welding

- An appropriate 5-lb or greater, multipurpose, dry-chemical fire extinguisher shall be located in all work areas where welding, cutting or other operations using an electric arc or open flame are being performed.
- All oxygen and/or acetylene cylinder valve seats, regulators, hose connectors and torches shall be kept free of grease or oil.
- All cylinders, regulators and hoses shall be protected from sparks and molten metal.
- All flammable materials such as plastic lighters shall be removed from clothing pockets before using an oxyacetylene torch.

FIRE SAFETY (OSHA Operations)

- When lighting oxyacetylene torches, only an approved striker shall be used.
 - All hoses and torches shall be purged and valves closed after use.
 - All stored oxygen and acetylene cylinders shall be upright and secured, with regulators removed and protective caps in place. Regulators may remain on compressed gas cylinders if a "hinged style" protective cap is used.
 - Welding, cutting or applying heat with an open flame to pipelines and/or containers that have or may have contained flammable/combustible liquids, flammable gases or explosive solids shall be prohibited, unless the pipeline or container has been drained, thoroughly cleaned of residue and ventilated, or shall be drained, thoroughly cleaned of residue and filled with an inert gas or water.
- D. Housekeeping
- Waste materials such as paper or oily rags shall not be allowed to accumulate and shall be disposed of promptly and by approved methods.
 - Combustible materials shall not be stored nor allowed to accumulate within 25 feet of electric substations, flammable and/or combustible liquid storage tanks, flammable and/or combustible drum storage areas and fueling areas.
 - Non-approved liquids shall not be used for the cleaning of parts.
 - Solvents shall not be used in such a manner as to cause them to ignite due to being exposed to excessive heat and/or open flame.
 - Combustible and flammable liquids shall not be allowed to accumulate on the floor or maintenance areas through spillage or routine maintenance procedures. Any spilled combustible or flammable liquid shall be promptly cleaned-up by means of absorbent materials, which shall be promptly and properly disposed of.
 - All flammable liquids, which must be stored in small quantities, shall be stored in properly labeled safety cans and in areas that are not within 25 feet of sources producing electric arcs, open flames or excessive heat.
 - Areas used for the charging of batteries shall be well ventilated to prevent the accumulation of hydrogen gas and posted with NO SMOKING OR OPEN FLAMES signage.
 - No person shall smoke or use an open flame where flammable or combustible materials are used, transported in a manner that could create a fire hazard, stored or handled.
 - Signs prohibiting smoking and the use of open flames shall be posted where fire or explosive hazards exist.

FIRE SAFETY (OSHA Operations)

E. Chemicals

- Prior to handling or using a chemical, employees shall check the NFPA chemical hazard label on the chemical container to identify the hazards associated with the handling and use of the chemical. Refer to NFPA Chemical Hazard Label (included in this section).
- Prior to handling or using a chemical, employees shall refer to the MSDS for that chemical to identify fire hazards associated with the handling and use of that chemical. Refer to Hazard Communication section of this manual

- 1.5. Training** – Fire prevention, evacuation and rescue procedures, proper fire fighting techniques, and the proper use of fire extinguishers will be addressed as an annual safety training topic.
- 1.6. Posting** – Areas where a fire or explosion hazard exists shall be posted with signs which prohibit smoking and the use of open flames.
- 1.7. Monitoring and Enforcement** – Safety personnel and/or supervisors will monitor and enforce this policy. Employees who refuse to adhere to the requirements of this policy shall be subject to disciplinary action.

2. EVACUATION AND RESCUE PLAN

- 2.1.** See Emergency Action Plan section of this manual.

3. STATUTORY REFERENCES

- 3.1.** 29 CFR § 1910 Subpart L – Fire Protection.
- 3.2.** 29 CFR § 1910 Subpart E – Means of Egress.
- 3.3.** 30 CFR § 56.4100 – Smoking and use of open flames.
- 3.4.** 30 CFR § 56.4101 – Warning signs.
- 3.5.** 30 CFR § 56.4102 – Spillage and leakage.
- 3.6.** 30 CFR § 56.4103 – Fueling internal combustion engines.
- 3.7.** 30 CFR § 56.4104 – Combustible waste.
- 3.8.** 30 CFR § 56.4130 – Surface electric substations and liquid storage facilities.
- 3.9.** 30 CFR § 56.4200.a and b – Firefighting equipment.
- 3.10.** 30 CFR § 56.4201 – Inspection of fire extinguishers.
- 3.11.** 30 CFR § 56.4203 – Extinguisher recharging or replacement.

FIRE SAFETY (OSHA Operations)

- 3.12.** 30 CFR § 56.4230 – Surface self-propelled equipment.
- 3.13.** 30 CFR § 56.4330.a – Surface firefighting, evacuation and rescue procedures.
- 3.14.** 30 CFR § 56.4400 – Use restrictions for flammable and combustible liquids and gases.
- 3.15.** 30 CFR § 56.4402 – Safety can use.
- 3.16.** 30 CFR § 56.4500 – Heat sources.
- 3.17.** 30 CFR § 56.4501 – Fuel lines.
- 3.18.** 30 CFR § 56.4502 – Battery charging stations.
- 3.19.** 30 CFR § 56.4505 – Fuel lines to underground areas.
- 3.20.** 30 CFR § 56.4530 – Exits for surface buildings and structures.
- 3.21.** 30 CFR § 56.4531 – Surface flammable and combustible liquid storage buildings and rooms.
- 3.22.** 30 CFR § 56.4600 – Extinguishing equipment for welding, cutting and compressed gas areas.
- 3.23.** 30 CFR § 56.4601 – Oxygen cylinder storage.
- 3.24.** 30 CFR § 56.4602 – Gages and regulators.
- 3.25.** 30 CFR § 56.4603 – Closure of valves.
- 3.26.** 30 CFR § 56.4604 – Preparation of pipelines and containers.

FIRE SAFETY (OSHA Operations)

NFPA Chemical Hazard Label

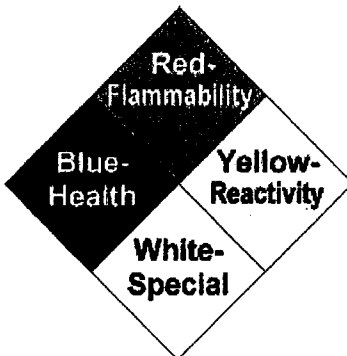

Rating Summary		
Health (Blue)		
4	Danger	May be fatal on short exposure. Specialized protective equipment required
3	Warning	Corrosive or toxic. Avoid skin contact or inhalation
2	Warning	May be harmful if inhaled or absorbed
1	Caution	May be irritating
0		No unusual hazard
Flammability (Red)		
4	Danger	Flammable gas or extremely flammable liquid
3	Warning	Flammable liquid flash point below 100° F
2	Caution	Combustible liquid flash point of 100° to 200° F
1		Combustible if heated
0		Not combustible
Reactivity (Yellow)		
4	Danger	Explosive material at room temperature
3	Danger	May be explosive if shocked, heated under confinement or mixed with water
2	Warning	Unstable or may react violently if mixed with water
1	Caution	May react if heated or mixed with water but not violently
0	Stable	Not reactive when mixed with water
Special Notice Key (White)		
W		Water Reactive
Oxy		Oxidizing Agent

Special Precaution Symbols



Flammable



Explosive



Corrosive



Poison

Lehigh Hanson
HEIDELBERGCEMENT Group

**Personal Protective Equipment Policy
OSHA Operations**

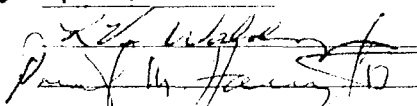
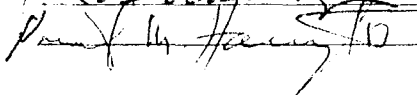
Effective Date	<u>March 1, 2011</u>		
Revision Date	<u>April 20, 2016</u>		
Approval		Date	<u>02/18/11</u>
Approval		Date	<u>02/18/11</u>

PERSONAL PROTECTIVE EQUIPMENT (OSHA Operations)

1. CORPORATE POLICY, REQUIREMENTS AND PROCEDURES

1.1. Purpose – To establish requirements for the use of personal protective equipment (PPE).

1.2. Requirements

- A. Management is required to provide as safe a work place as possible.
 - Each plant manager or his designee shall:
 - Analyze the various jobs being performed at his/her respective location.
 - Determine the types of hazards related to each of the various jobs being performed at his/her respective location.
 - Select and/or purchase proper personal protective equipment such as safety hard hats, safety glasses, life jackets, etc., which are necessary to provide adequate protection against the hazards identified for each of the various jobs being performed at his/her respective location.
 - Ensure that all required personal protective equipment is available, appropriate and well maintained.
 - All supervisors are charged with the responsibility of enforcing all applicable federal, state and company regulations and rules regarding the wearing and use of personal protective equipment.
- B. All employees are required to wear personal protective equipment such as, but not limited to, safety hard hats, safety glasses and protective footwear.
 - When using company-owned safety equipment, the employee is charged with the responsibility of proper care, maintenance, and use of the equipment. Each employee is charged with the responsibility of notifying his/her foreman when and if new equipment needs to be purchased and/or existing equipment needs to be maintained.

1.3. Training

- A. Employees will be instructed in the proper use of personal protective equipment. This instruction shall include:
 - When PPE is necessary.
 - What PPE is necessary.
 - How to properly don, doff, adjust and wear PPE.
 - The limitations of the PPE.
 - The proper care, maintenance, useful life and disposal of the PPE.
- B. This training shall include a process by which each employee shall demonstrate an understanding of the training provided and demonstrate the ability to use PPE properly, before an employee shall be allowed to perform work requiring the use of PPE.
 - In cases where management does not believe that an employee has adequate understanding and ability, the employee shall receive additional training.

PERSONAL PROTECTIVE EQUIPMENT (OSHA Operations)

C. PPE and the topics listed above will be a periodic safety-training topic.

1.4. Monitoring and Enforcement – The plant manager, his designee, and other LEHIGH HANSON employees, when present, shall be responsible for implementation and enforcement of this policy. Failure to use proper personal protective equipment can result in an employee receiving a safety violation notice, loss of safety incentive and/or disciplinary action up to and including termination of employment.

1.5. Assessment

A. General guidelines shall be followed when assessing foot, head, eye and face, and hand hazards that exist in the workplace and when matching PPE to the particular hazards found. It shall be the responsibility of the plant manager, with the assistance of the Safety Department, to select the appropriate personal protection equipment PPE based on the particular hazards found during the assessment of a site.

B. The plant manager or his designee shall verify that the required workplace hazard assessment has been performed through a written certification that identifies:

- The workplace evaluated.
- The name of the person certifying that the evaluation has been performed.
- The date(s) of the hazard assessment.
- The document as a certification of hazard assessment.
 - Refer to the “Workplace Hazard Assessment Certification Form” included in this section.

C. The following procedure should be followed in assessing workplace hazards:

- Conduct a walk-through survey of all work areas, giving consideration to the following basic hazard categories:
 - Impact.
 - Penetration.
 - Compression (rollover).
 - Chemical.
 - Heat.
 - Harmful dust or inhalants.
 - Light (optical) radiation.
 - Noise levels
 - Fall hazards
- During the walk-through survey, the following observations should be made:
 - Sources of motion such as machinery or processes, where any movement of tools, elements or particles could exist, or movement of personnel could result in collision with stationary objects.
 - Sources of high temperature that could result in burns, eye injury, ignition of protective equipment, etc.
 - Types of chemical exposures.

PERSONAL PROTECTIVE EQUIPMENT (OSHA Operations)

- Sources of harmful dust or inhalants.
 - Sources of light radiation such as welding, brazing, cutting, high intensity lights, etc.
 - Sources of falling objects or potential for dropping objects.
 - Sources of sharp objects that might cut or pierce the feet or hands.
 - Sources of rolling or pinching objects that could crush the feet or hands.
 - Any electrical hazards.
 - Layout of the workplace and location of the employees.
- In addition to the walk-through, all injury and accident records should be reviewed to help identify possible problem areas.
- D. Upon completion of the walk-through and review of records, all information should be organized and reviewed in order to best determine all possible hazards in the work place and to best select PPE to protect against those hazards.
- E. Required personal protective equipment selection can be documented on the form entitled, "Workplace Hazard Assessment Certification Form," included in this section.
- F. In some instances as a result of the annual workplace hazard assessment, management shall elect to administer a "gate-to-gate" policy regarding the use of certain personal protective equipment such as safety hard hats, safety eyewear and protective footwear.
- G. **Selection and Use of Personal Protective Equipment (PPE) – General Guidelines**
- The following basic guidelines will be used in selecting and using PPE:
- Become familiar with the potential hazards in the workplace and the type and effectiveness of available protective equipment.
 - Be aware of the possibility of multiple and simultaneous exposure to a variety of hazards.
 - Select the PPE that ensures a level of protection greater than the minimum required to protect employees from the hazards. Adequate protection against the highest level of each of the hazards should be provided. Remember that PPE does not provide unlimited protection against hazards.
 - Compare the hazards associated with the environment with the capabilities of the PPE.
 - Fit the user with the PPE.
 - Provide instruction or training on care and use of the PPE. Employees shall be made aware of the limitations of the PPE and also how to maintain the proper fit of the PPE.

PERSONAL PROTECTIVE EQUIPMENT (OSHA Operations)

H. Head Protection – General Guidelines

- Protective hard hats shall comply with ANSI Z89.1-1986.
- Employees shall wear protective hard hats when working in areas where there is a potential for a head injury from falling objects. All hard hats shall be designed to provide this protection. Some examples include:
 - Working below other workers who are using tools and materials that could fall.
 - Working around or under equipment such as a conveyor belt that are carrying material which could fall.
 - Working on exposed energized conductors.
- Electric shock and burn hazards shall be guarded against, as well as dangers from falling objects, when selecting hard hats. Hard hats designed to reduce electrical shock hazards (those made of a material other than aluminum or other conductive material) shall be worn by each affected employee when near exposed electrical conductors that could contact the head or other electrical hazard.

I. Head Protection – Selection

- Based on the most current assessment of the site, the mandatory requirements for the selection and use of protective hard hats, etc. is specified in the section entitled “Mandatory Personal Protective Equipment Policy and Procedures” of this policy.

J. Eye and Face Protection – General Guidelines

- Employees shall use appropriate eye and face protection when exposed to hazards due to:
 - Flying particles.
 - Molten metal.
 - Liquid chemicals.
 - Acids or caustic liquids.
 - Chemical gases or vapors.
 - Potentially injurious light radiation.
- Protective eye and face equipment shall comply with ANSI Z87.1-1989.
- Face shields, if required, shall be worn only over primary eye protection such as glasses or goggles.
- Persons whose vision requires the use of prescription lenses shall wear either protective equipment fitted with prescription lenses or protective equipment designed to be worn over regular prescriptive eyewear.
- Wearers of contact lenses shall also wear appropriate eye and face protection equipment in a hazardous environment. Dusty and chemical environments may represent an additional hazard to contact lens wearers.

PERSONAL PROTECTIVE EQUIPMENT (OSHA Operations)

- The chart – “Eye and Face Protection Selection Chart,” included in this section, provides general guidance for the selection of eye and face protection to protect against hazards associated with the listed hazard "source" operations.
- The chart – “Filter Lens Shade Numbers for Protection Against Radiant Energy,” included in this section, provides general guidance for the selection of eye protection against radiant energy.

K. Eye and Face Protection – Selection

- Based on the most current assessment of the site, the mandatory requirements for the selection and use of side protection, safety lenses, filter lenses, etc. is specified in the section entitled “Mandatory Personal Protective Equipment Policy and Procedures” of this policy.

L. Foot Protection – General Guidelines

- Employees shall wear safety shoes or boots when working in areas where there is a danger of foot injury from falling or rolling objects.
- Protective safety shoes shall comply with ASTM F2413-05..
- Protective safety shoes shall provide both impact and compression protection, depending upon the work activity being done by the employee.

M. Foot Protection – Selection

- Based on the most current assessment of the site, the mandatory requirements for the selection and use of protective safety shoes, etc. is specified in the section entitled “Mandatory Personal Protective Equipment Policy and Procedures” of this policy.

N. Hand Protection – General Guidelines

- Employees shall use the appropriate hand protection whenever their hands are exposed to hazards from:
 - Skin absorption of harmful substances.
 - Severe cuts or lacerations.
 - Severe abrasions.
 - Punctures.
 - Chemical burns.
 - Thermal burns.
 - Harmful temperature extremes.
 - Vibration.
- Appropriate hand protection shall be based on an evaluation of:
 - The performance of the hand protection relative to the tasks to be performed.
 - The conditions present.

PERSONAL PROTECTIVE EQUIPMENT (OSHA Operations)

- The duration of use.
 - The actual and potential hazards identified.
- Commonly available glove materials provide only limited protection against many chemicals.

O. Hand Protection – Selection

- Based on the most current assessment of the site, the mandatory requirements for the selection and use of appropriate hand protection is specified in the section entitled “Mandatory Personal Protective Equipment Policy and Procedures” of this policy.

1.6. Mandatory Personal Protective Equipment Policy and Procedures

A. Safety Hard Hats

- All employees and visitors on LEHIGH HANSON properties beyond the main office and scales shall wear safety hard hats.
- All employees delivering to construction sites or performing work on construction sites shall wear safety hard hats.
- The company will provide LEHIGH HANSON-approved safety hard hats for all employees. All new hires will be provided with a high visibility orange hard hat during their first 90 days of employment. All other employees will be provided with a high visibility green hard hat.
- All visitors will be provided with a LEHIGH HANSON-approved high visibility orange hard safety hat for use during their plant visit.
- Protective hard hats must meet the ANSI Z89.1-2009 standard. The company standard hard hats colors are Hi Viz Orange and Hi Viz Yellow/Green for MSA or equivalent Hi Viz color for non-MSA and will be strictly enforced to ensure consistency from operation to operation. To maximize cost savings, it is strongly recommended that all hard hat purchases be made using the existing corporate contract and online safety supply vendor for all hard hat purchases as well as other safety supply purchases.
- Safety hard hats and webbing shall be inspected daily and replaced if defects that affect the integrity of the hard hat or webbing is found. Manufacturers of hard hats recommend that hard hats and webbing be replaced at certain intervals. Refer to hard hat manufacturer’s recommendation of frequency of hard hat and webbing replacement.
- Safety hard hats will always be worn with the brim to the front. Welding masks will be of the type that clears the peak when raised or lowered.

PERSONAL PROTECTIVE EQUIPMENT (OSHA Operations)

- If hazards require other types of protective accessories to be used, employees will use LEHIGH HANSON-approved accessories that attach to the LEHIGH HANSON-approved safety hard hat. (See attached illustration.)

B. Safety Eyewear

- All employees and visitors on LEHIGH HANSON properties shall wear LEHIGH HANSON-approved safety glasses with side shields or other specially required eye protection at all times upon entry onto company property beyond the main office and scales.
- All employees delivering to construction sites or performing work on construction sites shall wear LEHIGH HANSON-approved safety glasses with side shields or other specially required eye protection.
- The company will provide each employee with eye protection under this policy as follows:
 - LEHIGH HANSON-approved safety glasses will be issued to the employee who needs uncorrected lens at no cost to the employee.
 - The company will reimburse an employee toward the purchase of prescription safety glasses in the amount of \$125.00. Additional reimbursement amounts are subject to the approval of the Region President. This policy shall be enforced unless collective bargaining agreements differ. In such cases, the terms of the collective bargaining agreements will prevail. The plant manager or their designee will decide if prescription safety glasses need to be replaced under this policy due to damage resulting from work activities. All regular and prescription safety glasses, goggles, etc. must meet ANSI Z87.1.1989 safety requirements. An employee must show proof of purchase to their supervisor. Prescription safety glass reimbursement for new hires will be contingent on the satisfactory completion of the probationary period.
- LEHIGH HANSON-approved safety glasses will be furnished to visitors as needed.

C. Protective Footwear

- All LEHIGH HANSON employees and others working on site shall wear appropriate footwear in all areas beyond the main office or scales.
- All employees delivering to construction sites or performing work on construction sites shall wear appropriate footwear.
 - This footwear shall meet the following requirements:
 - ✓ Must meet the ASTM F2413-05 standard.
 - ✓ Must be of leather or rubber composition.
 - ✓ Must have non-slip soles.
 - ✓ Must be of high top design with a height of five inches or more.

PERSONAL PROTECTIVE EQUIPMENT (OSHA Operations)

- The company will reimburse an employee toward the purchase of LEHIGH HANSON-approved protective footwear in the amount of \$200.00. Additional reimbursement amounts are subject to the approval of the Region President. This policy shall be enforced unless collective bargaining agreements differ. In such cases, the terms of the collective bargaining agreements will prevail. An employee must show proof of purchase to their supervisor. Reimbursement for new hires will be contingent on the satisfactory completion of the probationary period.

D. Seat Belts

- All LEHIGH HANSON employees shall inspect, maintain and use seat belts when operating and/or riding in mobile equipment equipped with seat belts by the manufacturer.
 - With respect to this policy, mobile equipment includes vehicles designed for both on-highway and off-highway use.
 - Many manufacturers of mobile equipment require that seat belts be replaced at certain intervals. Refer to equipment manufacturer's recommendation of frequency of seat belt replacement.
 - Worn or damaged seat belts, used in off-highway equipment, shall be replaced with belts meeting the requirements of SAE J386. These belts shall meet OEM specifications.
 - Worn or damaged seat belts, used in on-highway equipment shall be replaced with belts meeting OEM specifications.

E. Wearing Apparel

- All LEHIGH HANSON employees shall wear appropriate Hi Viz clothing for each specific job task being performed.
 - Clothing that becomes saturated with oil, grease or chemicals shall be changed by the next shift.
 - Ragged or excessively loose-fitting clothing shall not be worn when working on or around moving or rotating equipment and machinery.
 - Sleeved shirts (not brief or tank top styles) shall be worn at all times.
 - Long pants (without cuffs) shall be worn at all times, unless prior authorization is obtained.
 - Shirttails shall remain "tucked-in" when working on or around moving or rotating equipment and machinery.
 - Long hair (below collar length) should be worn in a net or tied and put under a hard hat when working on or around moving or rotating equipment and machinery.
 - Neither finger rings nor loose/swinging jewelry shall be worn when working on or around moving or rotating equipment and machinery.

F. Other Personal Protective Equipment

PERSONAL PROTECTIVE EQUIPMENT (OSHA Operations)

- Other personal protective equipment to be used for various tasks due to the associated hazards include, but is not limited to:
 - **Chemicals** – Aprons, rubber gloves and an appropriate cartridge respirator shall be used.
 - **Construction and highway work sites** – Use of high visibility vests as required.
 - **Cutting with oxygen/acetylene torch** – Cutting goggles with a minimum of a #5 shaded lens (safety glasses are not approved for the cutting process), fire resistant gloves, and non-flammable clothing such as 100 percent cotton shall be used.
 - **Dusty areas** – An approved respirator shall be worn in plants, tunnels or other areas where excessive dust may be a problem. Refer to the Respiratory Protection section of this manual.
 - **Electrical** – Hot sticks and rubber insulated/tested electrical gloves shall be used when working with or around electrical current. All applicable lockout/tagout procedures shall also be followed to control and /or guard against the release of energy.
 - **Grinding** – Safety goggles or safety glasses with side shields worn under a face shield shall be used.
 - **Heights** – A safety harness, lifeline and an attendant to tend the lifeline shall be used when working or entering bins, hoppers, silos, conveyor platforms, etc., where there is a potential danger of falling.
 - **Maintenance** – Wet weather gear and gloves shall be used as conditions and/or hazards warrant.
 - **Noise** – Ear plugs or earmuffs shall be used in designated areas. Refer to the Hearing Protection section of this manual.
 - **Sandblasting** – Air-supplied hood and protective clothing including gloves shall be used.
 - **Spray painting** – Proper paint respirator and eye protection shall be used.
 - **Steam/pressure cleaning** – Eye protection shall be used; rubber boots and gloves should be used when appropriate.
 - **Water hazards** – USCG-approved life jackets shall be used.
 - **Welding** – Welding hood with proper gradient lens for the type of welding being performed, leather aprons, high cuff leather gloves (gauntlets) and non-flammable clothing such as 100 percent cotton shall be used. If two or more employees are welding simultaneously, special care must be taken to prevent

PERSONAL PROTECTIVE EQUIPMENT (OSHA Operations)

weld flash energy from entering from the back side of the welding hood. If the employee is exposed to welding fumes due to the welding operation being performed in an enclosed space, and the welding fumes can not be removed from the welding area by fan or suction, the proper cartridge type respirator shall be used. When chipping is being performed, safety glasses with side shields or safety goggles must be worn unless a welding shield with a flip-up gradient lens and stationary clear lens is being used in the lowered position. (Refer to "Filter Lens Shade Numbers for Protection Against Radiant Energy," included in this section.)

- **Wet Weather/Wet Areas** – Rubber boots/over boots and rain suits should be used.

1.7. Recordkeeping

- A. The plant manager or his designee shall maintain all records including assessment, inspection and training records.
- B. Training shall be documented by means of LEHIGH HANSON "Training Documentation Forms" and/or LEHIGH HANSON "Safety Meeting Forms" and a copy shall be placed in each employee's file (see Training section of this manual). Training records shall be retained for a period of three years from the date of the training and shall include the following information:
 - Employee's name.
 - Date of training.
 - Outline describing the training material.
 - Signature of trainer documenting that training was provided.
 - Signature of employee documenting that training was received.
- C. The plant manager or his designee shall perform a workplace hazard assessment and verify the required personal protective equipment for each job within the workplace by completing, dating and signing the form entitled "Workplace Hazard Assessment Certification Form."

2. STATUTORY REFERENCES

- 2.1. 29 CFR § 1910.132 – General requirements.
- 2.2. 29 CFR § 1910.133 – Eye and face protection.
- 2.3. 29 CFR § 1910.134 – Respiratory Protection.
- 2.4. 29 CFR § 1910.135 – Head protection.
- 2.5. 29 CFR § 1910.136 – Occupational foot protection.
- 2.6. 29 CFR § 1910.137 – Electrical protective devices.
- 2.7. 29 CFR § 1910.138 – Hand Protection.

PERSONAL PROTECTIVE EQUIPMENT (OSHA Operations)

- 2.8.** 30 CFR § 56.15002 – Hard hats.
- 2.9.** 30 CFR § 56.15003 – Protective footwear.
- 2.10.** 30 CFR § 56.15004 – Eye protection.
- 2.11.** 30 CFR § 56.15005 – Safety belts and lines.
- 2.12.** 30 CFR § 56.15006 – Protective equipment and clothing for hazards and irritants.
- 2.13.** 30 CFR § 56.15007 – Protective equipment or clothing for welding, cutting, or working with molten metal.
- 2.14.** 30 CFR § 56.15014 – Eye protection when operating grinding wheels.
- 2.15.** 30 CFR § 56.15020 – Life jackets and belts.
- 2.16.** 30 CFR § 56.5005 – Control of exposure to airborne contaminants.
- 2.17.** The Program Policy Manual – Control of exposure to airborne contaminants.
- 2.18.** 30 CFR § 56.5050 – Exposure limits for noise.
- 2.19.** The Program Policy Manual – Definition of noise standard compliance.

PERSONAL PROTECTIVE EQUIPMENT (OSHA Operations)

Eye and Face Protection Selection Chart		
Source	Assessment of Hazard	Protection
<p>Impact:</p> <p>chipping grinding machining masonry work woodworking sawing drilling chiseling power fastening riveting sanding</p>	<p>flying fragments flying objects large chips particles sand dirt etc.</p>	<p>glasses with side protection goggles faceshields</p> <p>Notes: (1), (3), (5), (6), (10) For severe exposure use a faceshield</p>
<p>Heat:</p> <p>furnace operations pouring casting hot dipping</p>	<p>hot sparks</p> <p>Splash from molten metals</p>	<p>faceshields goggles glasses with side protection</p> <p>Notes: (1), (2), (3) For severe exposure use a faceshield. faceshields worn over goggles</p> <p>Notes: (1), (2), (3)</p>
	<p>high temperature exposure</p>	<p>screen faceshields reflective faceshields</p> <p>Notes: (1), (2), (3)</p>
<p>Chemicals:</p> <p>acid and chemical handling degreasing plating</p>	<p>splash</p>	<p>goggles (eye cup and cover types).</p> <p>Notes: (3), (11) For severe exposure use a faceshield.</p>
	<p>Irritating mist</p>	<p>Special purpose goggles</p>

PERSONAL PROTECTIVE EQUIPMENT (OSHA Operations)

Eye and Face Protection Selection Chart		
Source	Assessment of Hazard	Protection
Dust: woodworking buffing general dusty conditions.	nuisance dust	goggles (eye cup with cover types) Note: (8)
Light and/or Radiation: electric arc welding	optical radiation	welding goggles or welding faceshield with appropriate shade lens Notes: (9), (12)
gas welding	optical radiation	welding goggles or welding faceshield with appropriate shade lens Note: (9)
cutting brazing soldering	optical radiation	goggles or welding faceshield with appropriate shade lens Notes: (3), (9)
glare	poor vision	spectacles with shaded or special-purpose lenses, as suitable Notes (9), (10)

Notes to Eye and Face Protection Selection Chart:

(1) Care should be taken to recognize the possibility of multiple and simultaneous exposure to a variety of hazards. Adequate protection against the highest level of each of the hazards should be provided. Protective devices do not provide unlimited protection.

(2) Operations involving heat may also involve light radiation. As required by the standard, protection from both hazards must be provided.

(3) Faceshields should only be worn over primary eye protection (spectacles or goggles).

(4) As required by the standard, filter lenses must meet the requirements for shade designations in 1910.133(a)(5). Tinted and shaded lenses are not filter lenses unless they are marked or identified as such.

(5) As required by the standard, persons whose vision requires the use of prescription (Rx) lenses must wear either protective devices fitted with prescription (Rx) lenses or protective devices designed to be worn over regular prescription (Rx) eyewear.

PERSONAL PROTECTIVE EQUIPMENT (OSHA Operations)

(6) Wearers of contact lenses must also wear appropriate eye and face protection devices in a hazardous environment. It should be recognized that dusty and/or chemical environments may represent an additional hazard to contact lens wearers.

(7) Caution should be exercised in the use of metal frame protective devices in electrical hazard areas.

(8) Atmospheric conditions and the restricted ventilation of the protector can cause lenses to fog. Frequent cleansing may be necessary.

(9) Welding helmets or faceshields should be used only over primary eye protection (spectacles or goggles).

(10) Non-sideshield spectacles are available for frontal protection only, but are not acceptable eye protection for the sources and operations listed for "impact."

(11) Ventilation should be adequate, but well protected from splash entry. Eye and face protection should be designed and used so that it provides both adequate ventilation and protects the wearer from splash entry.

(12) Protection from light radiation is directly related to filter lens density. See note (4) . Select the darkest shade that allows task performance.

PERSONAL PROTECTIVE EQUIPMENT (OSHA Operations)

Filter Lens Shade Numbers for Protection Against Radiant Energy	
Welding/Cutting operation	Shade #
Shielded metal-arc welding 1/16, 3/32, 1/8, 5/32 inch diameter electrodes	10
Gas-shielded arc welding (nonferrous) 1/16, 3/32, 1/8, 5/32 inch diameter electrodes	11
Gas-shielded arc welding (ferrous) 1/16, 3/32, 1/8, 5/32 inch diameter electrodes	12
Shielded metal-arc welding 3/16, 7/32, 1/4 inch diameter electrodes	12
Shielded metal-arc welding 5/16, 3/8 inch diameter electrodes	14
Atomic hydrogen welding	10 - 14
Carbon-arc welding	14
Soldering	2
Torch brazing	3 - 4
Light cutting, up to 1 inch	3 - 4
Medium cutting, 1 inch to 6 inches	4 - 5
Heavy cutting, over 6 inches	5 - 6
Gas welding (light), up to 1/8-inch	4 - 5
Gas welding (medium), 1/8-inch to 1/2-inch	5 - 6
Gas welding (heavy), over 1/2-inch	6 - 8

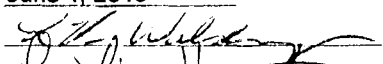
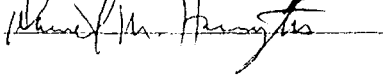

Hazard Communication Policy OSHA Operations

Effective Date	<u>March 1, 2011</u>		
Revision Date	<u>June 1, 2015</u>		
Approval		Date	<u>02/18/11</u>
Approval		Date	<u>02/18/11</u>

HAZARD COMMUNICATION (OSHA Operations)

1. CORPORATE POLICY, REQUIREMENTS AND PROCEDURES

1.1 Purpose – To establish requirements and procedures necessary to evaluate chemicals used at each respective operation. To provide and transmit information concerning classified physical and health hazards associated with these chemicals to employees who may encounter one or more of the chemicals on the job so that they may protect themselves with safe work practices. This revised standard is intended to be consistent with the provisions of the United Nations Globally Harmonized System of Classification and Labeling of Chemicals (GHS).

1.2 Definitions

- A. Access – The right to examine and copy records.
- B. Article – A manufactured item that is formed to a specific shape or design during manufacture and has end-use functions which depend on the shape or design and which under normal conditions of use does not release more than minute or trace amounts of a hazardous chemical.
- C. Chemical – Any substance, or mixture of substances.
- D. Chemical manufacturer – An employer with a workplace where chemicals are produced for use or distribution.
- E. Container – Any bag, barrel, bottle, box, can, cylinder, drum, reaction vessel, storage tank or the like that contains a hazardous chemical. Not included as containers for Hazard Communication purposes are pipes, piping systems, conveyors, engines, fuel tanks and other operating systems or parts in a vehicle.
- F. Employee – A worker who may be exposed to hazardous chemicals under normal operating conditions or in foreseeable emergencies.
- G. Exposure or exposed – Being subjected, or potentially subjected to a physical or health hazard in the course of employment. Exposure to health hazards includes inhalation, ingestion, skin contact or absorption.
- H. Hazard Category – A comparison of the level of hazard severity within a hazard class.
- I. Hazard Class – The nature of physical or health hazards (e.g. flammable, corrosive, irritant, carcinogen, etc.).
- J. Hazard Not Otherwise Classified (HNOC) – An adverse physical or health effect that is identified but is not captured by a GHS hazard category.
- K. Hazard Statement – A statement assigned to a hazard class and category that describes the nature of the hazard (s) of a chemical.
- L. Hazardous Chemical – Any chemical which is classified as a physical or health hazard, a simple asphyxiant, combustible dust, pyrophoric gas, or hazard not otherwise classified.

HAZARD COMMUNICATION (OSHA Operations)

- M. Health Hazard – A chemical which is classified as posing one of the following hazardous effects: acute toxicity (any route of exposure); skin corrosion or irritation; serious eye damage or eye irritation; respiratory or skin sensitization; germ cell mutagenicity; carcinogenicity; reproductive toxicity; specific target organ toxicity (single or repeated exposure); or aspiration hazard.
- N. Label – Any written, printed or graphic material displayed on or affixed to a container to identify its contents and convey other relevant information.
- O. Label elements – The specified pictogram, hazard statement, signal word and precautionary statement for each hazard class and category.
- P. Physical hazard – A chemical that has been classified as posing one of the following hazardous effects: explosive; flammable (gases, aerosols, liquids, or solids); oxidizer (liquid, solid or gas); self-reactive; pyrophoric (liquid or solid); self-heating; organic peroxide; corrosive to metal; gas under pressure; or in contact with water emits flammable gas.
- Q. Pictogram – A composition that may include a symbol plus other graphic elements, such as a border, background pattern, or color that is intended to convey specific information about the hazards of a chemical. Eight pictograms are designated under the standard.
- R. Precautionary Statement – A phrase that describes recommended measures that should be taken to minimize or prevent adverse effects resulting from exposure to a hazardous chemical, or improper storage or handling.
- S. Product Identifier – The name or number used for a hazardous chemical on a label or Safety Data Sheet (SDS).
- T. Raw Material – Ore, valuable minerals, worthless material or gangue, overburden, or a combination of these, that is removed from natural deposits by mining or is upgraded through milling.
- U. Safety Data Sheet (SDS) – The written or printed material concerning a hazardous chemical in compliance with the Hazardous Communication Standard and GHS requirements.
- V. Signal Word – A word used to indicate the relative level of severity of hazard and alert the reader to a potential hazard on the label. The signal words used in this section are “danger” and “warning”. “Danger” is used for more severe hazards, while “warning” is used for less severe.
- W. Work Area – A room or defined space in a workplace where hazardous materials are produced or used and where employees are present.

1.3 Hazard Communication Program

A. Requirements

HAZARD COMMUNICATION (OSHA Operations)

- Hazard Communication requirements apply to each operation storing, producing or using a hazardous chemical to which an employee may encounter under normal conditions or in a foreseeable emergency.

B. Exemptions

- Chemicals exempt from Hazard Communication requirements include:
 - Any pesticide when regulated by the Federal Insecticide, Fungicide and Rodenticide Act (FIFRA) when subject to the labeling requirements of the Environmental Protection Agency (EPA);
 - Any chemical substance or mixture as regulated by the Toxic Substances Control Act (TSCA) when subject to the labeling requirements issued under that Act by the Environmental Protection Agency;
 - Hazardous waste when regulated under the Resource Conservation and Recovery Act (RCRA) and the Comprehensive Environmental Response, Compensation, and Liability Act (CERCLA);
 - Articles which release no more than insignificant amounts of hazardous chemicals and pose no risk to exposed employees
 - Biological hazards;
 - Consumer products when used as intended by the manufacturer and the use of which does not expose employees more often or for longer periods than ordinary consumer use;
 - Food or alcoholic beverages which are sold, used or prepared in a retail establishment and foods intended for personal consumption by employees in the workplace;
 - Drugs intended for personal consumption by employees while in the workplace (e.g. first aid supplies);
 - Cosmetics intended for personal consumption by employees while in the workplace;
 - Ionizing and nonionizing radiation; and
 - Wood and wood products. Treated or painted wood products and wood dust are not exempt.

1.4 Hazard Classification

- A. Each chemical brought onto the site and each chemical produced on the site, including intermediate products and by-products, must be evaluated to determine the hazard classes, and where appropriate, the category of each class that applies to the chemical being classified.
 - Classifications that have already been performed on labels and SDS's by manufacturers or importers for chemicals that are brought on site do not have to be re-classified unless a workplace chooses not to rely on these classifications.

HAZARD COMMUNICATION (OSHA Operations)

- Chemical manufacturers, importers or employers classifying chemicals shall identify and consider the full range of available scientific literature and other evidence concerning the potential hazards. There is no requirement to test the chemical to determine how to classify its hazards. Appendix A to §1910.1200 shall be consulted for classification of health hazards, and Appendix B to §1910.1200 shall be consulted for the classification of physical hazards.
- When classifying mixtures:
 - Chemical manufacturers, importers, or employers evaluating chemicals shall follow the procedures described in Appendices A and B to §1910.1200 to classify the hazards of the chemicals, including determinations regarding when mixtures of the classified chemicals are covered by this section.
 - Chemical manufacturers and importers of mixtures may rely on the information provided on the current safety data sheets of the individual ingredients except where the chemical manufacturer or importer knows, or in the exercise of reasonable diligence should know, that the safety data sheet misstates or omits information required by this section.

Note: Products containing crystalline silica and having the potential to generate respirable dust exposure during normal downstream use are considered hazardous since respirable crystalline silica may cause lung damage and has been classified as a carcinogen.

1.5 Written HazCom Program

- A. Each operation must develop, implement, and maintain at each workplace, a written hazard communication program which at least describes how labels and other forms of warning, safety data sheets, and employee information and training requirements will be met, and which also includes:
 - A list of the hazardous chemicals known to be present using a product identifier that is referenced on the appropriate safety data sheet (the list may be compiled for the workplace as a whole or for individual work areas);
 - The methods the employer will use to inform employees of the hazards of non-routine tasks (for example, the cleaning of reactor vessels), and the hazards associated with chemicals contained in unlabeled pipes in their work areas;
 - The location of SDS's and how they are accessible to employees;
 - How Hazard Communication training is conducted for employees;
 - How relevant HazCom information is shared with other employers on site.
- B. List of Hazardous Materials
 - A list of all hazardous chemicals on site must be prepared and kept up-to-date. The list must:

HAZARD COMMUNICATION (OSHA Operations)

- Use a chemical identity which permits cross-referencing with the label and SDS.
 - Be compiled for the whole operation or by work areas.
 - If the list is compiled for the operation, include the location(s) where the chemical is used or stored.
 - If the list contains hazardous as well as non-hazardous chemicals, identify the hazardous chemicals.
 - Include part numbers as well as the manufacturer and product name so the list can be used to obtain missing SDS's.
- C. Each operation will make the written program available upon request to all employees, employees' designated representatives and representatives of OSHA.

1.6 Labels and other forms of warning

A. General Requirements

- All containers of hazardous materials shall be labeled, tagged or marked with the following information:
 - Product Identifier;
 - Signal Work;
 - Hazard Statement(s);
 - Pictogram(s);
 - Precautionary Statement(s); and
 - Name, address, and telephone number of the chemical manufacturer, importer, or other responsible party.

B. Exemptions

- Containers which are already labeled under other federal agency requirements, such as hazardous waste and consumer products do not have to be re-labeled.

C. Workplace Labeling

- The employer shall ensure that each container of hazardous chemicals in the workplace is labeled, tagged or marked with either:
 - The label components as defined in 1.6A above; or
 - Product identifier and words, pictures, symbols, or combination thereof, which provide at least general information regarding the hazards of the chemicals, and which, in conjunction with the other information immediately available to

HAZARD COMMUNICATION (OSHA Operations)

employees under the hazard communication program, will provide employees with the specific information regarding the physical and health hazards of the hazardous chemical.

- Written materials must be readily accessible to the employees in their work area throughout each work shift.
- Portable containers into which hazardous chemicals are transferred from labeled containers, and which are intended only for the immediate use of the employee who performs the transfer do not have to be labeled.
- Existing labels shall not be defaced on incoming containers of hazardous chemicals, unless the container is immediately marked with the required information.
- Workplace labels or other forms of warning must be legible, in English, and prominently displayed on the container, or readily available in the work area throughout each work shift.
- Employers having employees who speak other languages may add the information in their language to the material presented, as long as the information is presented in English as well.
- The operation is not responsible for an inaccurate label on a container obtained from the manufacturer or supplier; however, if a problem is noted, the manufacturer should be notified.
- If a revised label is received from the manufacturer, the operator must replace the outdated one.

D. Labels for Chemicals Produced on Site (Shipped Containers):

- The information provided on the label must be presented in accordance with 1.6 A above, Allocation of Label Elements, for each hazard class and associated hazard category for the hazardous chemical, prominently displayed, and in English (other languages may also be included if appropriate).
- Signs, placards, process sheets, batch tickets, operating procedures, or other such written materials may be used in lieu of affixing labels to individual stationary process containers, as long as the alternative method identifies the containers to which it is applicable and conveys the required label hazard information.
- When newly aware of any significant information regarding the hazards of a chemical, labels shall be revised for the chemical within six months and it shall be ensured that labels on containers of hazardous chemicals shipped after that time contain the new information. If the chemical is not currently produced or imported, the chemical manufacturer, importer, distributor, or employer shall add the information to the label before the chemical is shipped or introduced into the workplace again.

HAZARD COMMUNICATION (OSHA Operations)

- Each container of hazardous chemicals leaving the workplace shall be labeled, tagged, or marked in accordance with this section in a manner which does not conflict with the requirements of the Hazardous Materials Transportation Act (49 U.S.C. 1801 et seq.) and regulations issued under that Act by the Department of Transportation.

E. Solid Materials

- For solid metal (such as a steel beam or a metal casting), solid wood, or plastic items that are not exempted as articles due to their downstream use, or shipments of whole grain, the required label may be transmitted to the customer at the time of the initial shipment, and need not be included with subsequent shipments to the same employer unless the information on the label changes;
- The label may be transmitted with the initial shipment itself, or with the safety data sheet that is to be provided prior to or at the time of the first shipment; and,
- This exception to requiring labels on every container of hazardous chemicals is only for the solid material itself, and does not apply to hazardous chemicals used in conjunction with, or known to be present with, the material and to which employees handling the items in transit may be exposed (for example, cutting fluids or pesticides in grains).

1.7 Safety Data Sheets (SDS)

A. General Requirements

- Each operation shall obtain or develop a safety data sheet for each hazardous chemical they produce or import.
- Employers shall have a safety data sheet in the workplace for each hazardous chemical which they use.
- Safety data sheets shall be written in English (although the employer may maintain copies in other languages as well), and include at least the following section numbers and headings, and associated information under each heading, in the order listed (See Appendix D to §1910.1200 – Safety Data Sheets, for the specific content of each section of the safety data sheet):
 - Section 1 - Identification;
 - Section 2 - Hazard(s) identification;
 - Section 3 - Composition/information on ingredients;
 - Section 4 - First-aid measures;
 - Section 5 - Fire-fighting measures;
 - Section 6 - Accidental release measures;

HAZARD COMMUNICATION (OSHA Operations)

- Section 7 - Handling and storage;
 - Section 8 - Exposure controls/personal protection;
 - Section 9 - Physical and chemical properties;
 - Section 10 - Stability and reactivity;
 - Section 11 - Toxicological information.
 - Section 12 - Ecological information;
 - Section 13 - Disposal considerations;
 - Section 14 - Transport information;
 - Section 15 - Regulatory information; and
 - Section 16 - Other information, including date of preparation or last revision.
- Chemical manufacturers or importers shall ensure that distributors and employers are provided an appropriate safety data sheet with their initial shipment, and with the first shipment after a safety data sheet is updated;
 - The chemical manufacturer or importer shall either provide safety data sheets with the shipped containers or send them to the distributor or employer prior to or at the time of the shipment;
 - If the safety data sheet is not provided with a shipment that has been labeled as a hazardous chemical, the distributor or employer shall obtain one from the chemical manufacturer or importer as soon as possible; and,
 - The chemical manufacturer or importer shall also provide distributors or employers with a safety data sheet upon request;
 - The employer shall maintain in the workplace copies of the required safety data sheets for each hazardous chemical, and shall ensure that they are readily accessible during each work shift to employees when they are in their work area(s). (Electronic access and other alternatives to maintaining paper copies of the safety data sheets are permitted as long as no barriers to immediate employee access in each workplace are created by such options.);
 - Where employees must travel between workplaces during a workshift, i.e., their work is carried out at more than one geographical location, the safety data sheets may be kept at the primary workplace facility. In this situation, the employer shall ensure that employees can immediately obtain the required information in an emergency;
 - Safety data sheets may be kept in any form, including operating procedures, and may be designed to cover groups of hazardous chemicals in a work area where it may be more appropriate to address the hazards of a process rather than individual

HAZARD COMMUNICATION (OSHA Operations)

hazardous chemicals. However, the employer shall ensure that in all cases the required information is provided for each hazardous chemical, and is readily accessible during each work shift to employees when they are in their work area(s).

- Safety data sheets shall also be made readily available, upon request, to designated representatives, the Assistant Secretary, and the Director, in accordance with the requirements of 29 CFR 1910.1020(e).

1.8 Employee Information and Training

A. General Requirements:

- Employers shall provide employees with effective information and training on hazardous chemicals in their work area at the time of their initial assignment, and whenever a new chemical hazard the employees have not previously been trained about is introduced into their work area.
- Information and training may be designed to cover categories of hazards (e.g., flammability, carcinogenicity) or specific chemicals.
- Chemical specific information must always be available through labels and safety data sheets.

B. Information:

- Employees shall be informed of the contents of the OSHA Hazard Communication Standard, operations in their work area where hazardous chemicals are present, and the location of the site written program (including the list of hazardous chemicals) and SDS's.

C. Training content:

- Methods and observations that may be used to detect the presence or release of a hazardous chemical in the work area (such as monitoring conducted by the employer, continuous monitoring devices, visual appearance or odor of hazardous chemicals when being released, etc.);
- The physical, health, simple asphyxiation, combustible dust, and pyrophoric gas hazards, as well as hazards not otherwise classified, of the chemicals in the work area;
- The measures employees can take to protect themselves from these hazards, including specific procedures the employer has implemented to protect employees from exposure to hazardous chemicals, such as appropriate work practices, emergency procedures, and personal protective equipment to be used; and,
- The details of the hazard communication program developed by the employer, including an explanation of the labels received on shipped containers and the workplace labeling system used by their employer; the safety data sheet, including

HAZARD COMMUNICATION (OSHA Operations)

the order of information and how employees can obtain and use the appropriate hazard information.

- D. All hazard communication training must be documented by completing and signing a LEHIGH HANSON training documentation form.

1.9 Multi-employer workplaces

- A. Employers who produce, use, or store hazardous chemicals at a workplace in such a way that the employees of other employer(s) may be exposed (for example, employees of a construction contractor working on-site) shall additionally ensure that the hazard communication programs developed will include the following:
 - The methods the employer will use to provide the other employer(s) on-site access to safety data sheets for each hazardous chemical the other employer(s)' employees may be exposed to while working;
 - The methods the employer will use to inform the other employer(s) of any precautionary measures that need to be taken to protect employees during the workplace's normal operating conditions and in foreseeable emergencies; and,
 - The methods the employer will use to inform the other employer(s) of the labeling system used in the workplace.
- B. Each operation which has other operators on site will document the specific information shared with other operators, including the name of the representative(s) who received the information.

1.10 Monitoring and Enforcement – The plant manager or his designee is responsible for the implementation and enforcement of this policy. Failure to follow this policy can result in an employee receiving a safety violation notice, loss of safety incentive, and/or disciplinary action up to and including termination of employment.

2. STATUTORY REFERENCES

- 2.1 29 CFR 1910.1200 – Hazard Communication
- 2.2 29 CFR 1910. 1020 Access to Employee Medical and Exposure Records
- 2.3 30 CFR Part 47 – Hazard Communication (HazCom)
- 2.4 MSHA PROGRAM POLICY LETTER NO. P13-IV-01

RESPIRATORY PROTECTION (OSHA Operations)

1. CORPORATE POLICY, REQUIREMENTS AND PROCEDURES

1.1. **Purpose** – To establish the requirements and procedures to protect employees against overexposure to airborne contaminants.

1.2. Definitions

- A. **Air-purifying Respirator** – A respirator with an air-purifying filter, cartridge, or canister that removes specific air contaminants by passing ambient air through the air-purifying element.
- B. **Atmosphere-supplying Respirator** – A respirator that supplies the respirator user with breathing air from a source independent of the ambient atmosphere, and includes supplied-air respirators (SARs) and self-contained breathing apparatus (SCBA) units.
- C. **Canister or Cartridge** – A container with a filter, sorbent or catalyst, or combination of these items, which removes specific contaminants from the air passed through the container.
- D. **Filtering Facepiece (dust mask)** – A negative pressure particulate respirator with a filter as an integral part of the facepiece or with the entire facepiece composed of the filtering medium.
- E. **Fit Test** – The use of a protocol to qualitatively or quantitatively evaluate the fit of a respirator on an individual.
- F. **Immediately Dangerous to Life or Health (IDLH)** – An atmosphere that poses an immediate threat to life, would cause irreversible adverse health effects, or would impair an individual's ability to escape from a dangerous atmosphere.
- G. **Negative Pressure Respirator (tight fitting)** – A respirator in which the air pressure inside the facepiece is negative during inhalation with respect to the ambient air pressure outside the respirator.
- H. **Positive Pressure Respirator** – A respirator in which the pressure inside the respiratory inlet covering exceeds the ambient air pressure outside the respirator.
- I. **Qualitative Fit Test (QLFT)** – A pass/fail fit test to assess the adequacy of respirator fit that relies on the individual's response to the test agent.
- J. **Quantitative Fit Test (QNFT)** – An assessment of the adequacy of respirator fit by numerically measuring the amount of leakage into the respirator.
- K. **Self-contained Breathing Apparatus (SCBA)** – An atmosphere-supplying respirator for which the breathing air source is designed to be carried by the user.
- L. **Supplied-air Respirator (SAR) or Airline Respirator** – An atmosphere-supplying respirator for which the source of breathing air is not designed to be carried by the user.

RESPIRATORY PROTECTION **(OSHA Operations)**

M. User Seal Check – An action conducted by the respirator user to determine if the respirator is properly seated to the face.

1.3. Determination of Airborne Contaminant Exposure – Monitoring of the work place shall be conducted as often as necessary to determine if a level of airborne contaminants are present, which may impact the health of LEHIGH HANSON employees working in that area.

➤ Each plant manager or his designee shall:

- Analyze the various jobs being performed at his/her respective location.
- Determine if a level of airborne contaminants is present, which may impact the health of LEHIGH HANSON employees working in each area where the various jobs are being performed.
- Select and/or purchase proper respiratory protective equipment necessary to provide adequate protection against the hazards identified for each of the various jobs being performed at his/her respective location. (This should be based on the evaluation and recommendations of the Safety & Health Department.)
- Ensure that all required respiratory protective equipment is available, appropriate and well maintained.

1.4. Airborne Contaminant Exposure (Engineering Controls) – Airborne contaminant levels exceeding threshold limit values (TLV's) will first be reduced as much as possible through engineering controls. Examples of engineering controls are:

- A. Enclosing existing equipment cabs or installing new ones.
- B. Enclosing spouts in screening, mixing, bagging and other operations where cement, sand, rock or other dusty materials are dumped, where practical.
- C. Installing water, mist or fog sprays to prevent dust from escaping at the source; such as roads, screening equipment, bagging equipment, mixing equipment and transfer points, where practical.
- D. Installing dust collection systems to prevent dust from escaping at the source; such as screening equipment, bagging equipment, mixing equipment and transfer points, where practical.
- E. Using ventilation devices.

1.5. Respiratory Protection – Employees working in potentially hazardous breathing environments will be supplied with respiratory protection.

A. Use of respiratory protection shall be mandatory in designated areas when:

- Engineering controls are not feasible.
- During such time as engineering controls are being implemented, but are not complete.
- Working in posted areas.

B. Appropriate respiratory protection will be available from the Company. Employees will be instructed in the proper selection and use of respiratory protection.

RESPIRATORY PROTECTION (OSHA Operations)

- 1.6. Selection** – Respirators shall be selected which have been tested and approved by NIOSH for protection against the known hazard. The range of respirators available will be adequate to accommodate the physical characteristics of the employees to be fitted. The Safety & Health Department will provide assistance in the proper selection of respirators.
- A. The three filter series are referred to as N,R and P. The levels of filter efficiency are 95 percent, 99 percent and 99.9 percent against the most difficult size particle to filter.
- N-Series Filters – the “N” refers to “no oil in the air.” This filter may be used for solid or liquid particulate hazards that do not contain oil and where the hazard is only the particulate nature of the contaminant. Generally, these filters can be used and reused subject only to considerations of hygiene, damage and increased breathing resistance.
 - R-Series Filters – the “R” refers to “oil resistant.” This filter provides some protection against air that is contaminated with some particulate and has some oil present; however, this filter is not the best alternative. This filter may be used for any solid or liquid airborne particulate hazard. If the atmosphere contains oil, this filter can only be used for a single shift or eight hours of continuous or intermittent use.
 - P-Series Filters – the “P” refers to “oil proof.” This filter is intended for removal of any particulate, including oil-based liquid aerosols. This filter may be used for any solid or liquid particulate airborne hazard. Typical service life should not exceed 40 hours of continuous use or 30 days of intermittent use, unless hygiene or other reasons warrant earlier replacement.
- B. Where oil is suspected, but air samples have not been taken to determine its presence, a “P” series filter should be selected.

1.7. Training – Employees shall be trained in the proper use of respirators and their limitations.

- A. The employees shall be instructed in the nature of the hazard and an appraisal of what may happen if the respirator is not worn as required. Training will provide employees with the opportunity to handle a respirator and have it properly fitted, to test its face seal, and to wear it in normal air for familiarization. This training shall also include how to properly don, doff, adjust and wear a respirator; the limitations of the respirator; and the proper care, maintenance, useful life and disposal of the respirator.
- B. This training shall include a process by which each employee shall demonstrate an understanding of the training provided and demonstrate the ability to use the respirator properly, before an employee shall be allowed to perform work requiring the use of a respirator.
- In cases where management does not believe that an employee has adequate understanding and ability, the employee shall receive additional training.
- C. On hire and annually thereafter, affected employees will be trained in the proper use of respirators.

RESPIRATORY PROTECTION (OSHA Operations)

1.8. Posting

- A. Areas where employees are required to wear respiratory protection due to the presence of a potentially hazardous breathing environment will have a sign posted which will be visible from the work area. (See Example 1.)

1.9. Monitoring and Enforcement – Safety & Health personnel and/or supervisors will monitor and enforce the wearing of respiratory protection and will post signs in areas where hazardous breathing environments exist. Monitoring of the work place shall be conducted as often as necessary to determine if hazardous breathing conditions exist, and to determine the adequacy of any control measures being used. Employees who refuse to wear respiratory protection will be subject to disciplinary action.

1.10. Assessment

- A. General guidelines shall be followed when assessing respiratory hazards that exist in the workplace and when matching respiratory protection equipment to the particular hazards found. It shall be the responsibility of the plant manager, with the assistance of the Safety & Health Department, to select the appropriate respiratory protection equipment based on the particular hazards found during the assessment of a site.
- B. The plant manager or his designee shall verify that the required workplace hazard assessment has been performed through a written certification that identifies:
 - The workplace evaluated.
 - The name of the person certifying that the evaluation has been performed.
 - The date(s) of the hazard assessment.
 - The document as a certification of hazard assessment.
 - Refer to the “Workplace Hazard Assessment Certification Form” included in this section.
- C. The following procedure should be followed in assessing workplace hazards:
 - Conduct a walk-through survey of all work areas, giving consideration to harmful dust or inhalants.
 - During the walk-through survey, observations shall be made as to the sources of harmful dust or inhalants.
 - During the walk-through survey, monitoring of the work place shall be conducted to determine if levels of airborne contaminants are present that exceed the threshold limit values (TLV’s).
 - In addition to the walk-through, all respiratory illness records should be reviewed to help identify possible problem areas.
- D. Upon completion of the walk-through, monitoring, and review of records, all information should be organized and reviewed in order to best determine all possible hazards in

RESPIRATORY PROTECTION **(OSHA Operations)**

the work place and to best select respiratory protection equipment to protect against those hazards.

- E. The selection of required respiratory protection equipment can be documented on the form entitled "Worksite-Specific Respirator Plan," included in this section and the form entitled, "Job-Specific Personal Protective Equipment Requirements," included in the Personal Protection Equipment section of this manual.

1.11. Respiratory Protection Policy and Procedures

- A. All employees working in a potentially hazardous breathing environment will have access to respiratory protection.
- B. All employees working in potentially hazardous breathing environments are required to have their respiratory protection immediately available while on site.
- C. Respiratory protection is available at the job-site offices or from supervisors.
- D. Respiratory protection shall be worn while working in potentially hazardous breathing environments.
- E. All employees using respiratory protection shall use their respiratory protection in accordance with instructions and training received.
- F. If the necessity of wearing respiratory protection is in doubt, respiratory protection should be worn until such time as an accurate evaluation indicates that the environment is not a hazardous breathing environment.
- G. All employees having the need to wear respiratory protection will be certified as medically qualified to wear a respirator and then fit tested prior to wearing a respirator.
- H. Since beard growth (including "stubble") prevents an effective seal, all persons who are required to wear a respirator shall be clean-shaven over the skin surface that seals against the face piece of the respirator, unless the person is fitted with an approved hood type respirator.
- I. Each time an employee puts on a tight-fitting respirator, he/she shall perform a user seal check on the respirator.
- J. When respiratory protection is used in IDLH atmospheres, the presence of at least one other person with back-up equipment and rescue capability shall be required.

1.12. Medical Certification

- A. The Company will allow voluntary use of respirators by employees who by definition are not exposed to hazardous breathing environments, but who based on their own personal comfort level believe a respirator affords them additional comfort and/or protection. These employees will be allowed to wear a respirator only after:

RESPIRATORY PROTECTION (OSHA Operations)

- It has been determined that the use of the respirator will not in itself create a hazard.
 - It has been determined that the employee is medically qualified to wear a respirator. (Filtering facepiece exempt from requirement.)
 - The employee has received a copy of 29 CFR 1910.134, Appendix D (included in this section).
- B. The Company requires all employees exposed to hazardous breathing environments to be certified as medically qualified to wear a respirator prior to being fit tested for a respirator.
- C. Medical qualification shall be certified by the following medical evaluation procedure:
- Company shall obtain the services of a physician or other licensed health care professional to perform the medical qualification evaluation using either a medical questionnaire – Sections 1 and 2, Part A of Appendix C of 29 CFR 1910.134 or a medical examination.
 - Employee shall undergo the medical evaluation.
 - Any employee responding positively to any question among questions one through eight of the questionnaire, or who demonstrates the need for a follow-up medical examination as a result of the initial medical examination, shall undergo a follow-up medical examination.
 - The follow-up medical examination shall include any medical tests, consultations or diagnostic procedures that the administering physician or licensed health care professional deems necessary to make the final determination of medical qualification.
 - Only employees that are certified as medically qualified to wear a respirator shall be eligible for fit testing and respirator use.
- D. The Company shall require subsequent medical qualification evaluations for an employee who has been deemed medically qualified to wear a respirator, for any of the following reasons:
- Employee reports medical signs or symptoms that are related to his/her ability to use a respirator.
 - A physician, licensed health care professional or supervisor informs the Company that an employee needs to be reevaluated.
 - Information from the respiratory protection program, including observations made during fit testing and program evaluation, indicates a need for employee reevaluation.

1.13. Fit Testing

- A. The Company requires all employees exposed to potentially hazardous breathing environments to be fit tested with the same make, model, style and size of respirator that will be used, prior to wearing a respirator.
- Fit testing shall conform to OSHA-accepted fit test protocols found in Appendix A of 29 CFR 1910.134.

RESPIRATORY PROTECTION (OSHA Operations)

1.14. Respirator Maintenance – Respirators shall be cleaned and disinfected regularly. The maintenance program will be adjusted according to the type and size of the operation where respirators are to be worn. A minimum program shall include cleaning, inspection for defects and repair. Respirators should be cleaned after each day's use. Whenever possible, a respirator shall be assigned to each worker for his/her exclusive use.

- A. The Company shall provide training describing acceptable respirator cleaning and maintenance procedures for each employee required to use respiratory protection.
- B. The following procedure shall be followed when cleaning and maintaining respirators:
 - Remove and discard filters.
 - Wash face piece in a detergent/disinfectant solution (warm temperature at 140° F).
 - Rinse face piece completely in clean warm water.
 - Air dry in a clean area.
 - Inspect valves, head straps and other parts.
 - Replace defective parts with NIOSH-approved parts designed for the respirator.
 - Insert new filters, making sure correct filters are used and the seal is tight.
 - Place assembled respirator in plastic bag for storage.

1.15. Recordkeeping

- A. The plant manager or his designee shall maintain all records including assessment, respirator selection, medical certification, fit testing and training records.
- B. Training shall be documented by means of LEHIGH HANSON "Training Documentation Forms" and/or LEHIGH HANSON "Safety Meeting Forms" and a copy shall be placed in each employee's file (see manual section on Training). Training records shall be retained for a period of three years from the date of the training and shall include the following information:
 - Employee's name.
 - Date of training.
 - Outline describing the training material.
 - Signature of trainer documenting that training was provided.
 - Signature of employee documenting that training was received.
- C. The plant manager or his designee shall verify the required respiratory protective equipment for each job within the workplace by completing, dating and signing the form entitled "Worksite-Specific Respirator Plan," included in this section and the form entitled, "Job Specific Personal Protective Equipment Requirements," included in Personal Protection Equipment section of this manual.
- D. The plant manager or his designee shall verify that the required workplace hazard assessment has been performed by completing, dating and signing the written certification form entitled, "Workplace Hazard Assessment Certification Form."

2. STATUTORY REFERENCES

2.1. 29 CFR § 1910.134 - Respiratory Protection.

RESPIRATORY PROTECTION

(OSHA Operations)

- 2.2.** 29 CFR § 1910.134 App B-1 - User Seal Check Procedures.
- 2.3.** 29 CFR § 1910.134 App B-2 - Respiratory Cleaning Procedures.
- 2.4.** 29 CFR § 1910.134 App C - OSHA Respirator Medical Evaluation Questionnaire.
- 2.5.** 29 CFR § 1910.134 App D - Information for Employees Using Respirators When not Required Under Standard.
- 2.6.** 30 CFR § 56.5005 – Control of exposure to airborne contaminants.
- 2.7.** The Program Policy Manual – Control of exposure to airborne contaminants.
- 2.8.** 30 CFR § 56/57.5002 – Exposure monitoring.

**RESPIRATORY PROTECTION
(OSHA Operations)**

**RESPIRATORY
PROTECTION
REQUIRED WHEN
ENTERING THIS
AREA**

EXAMPLE 1

RESPIRATORY PROTECTION

Appendix D to Sec. 1910.134

(Mandatory) Information for Employees Using Respirators When Not Required Under the Standard

Respirators are an effective method of protection against designated hazards when properly selected and worn. Respirator use is encouraged, even when exposures are below the exposure limit, to provide an additional level of comfort and protection for workers. However, if a respirator is used improperly or not kept clean, the respirator itself can become a hazard to the worker. Sometimes, workers may wear respirators to avoid exposures to hazards, even if the amount of hazardous substance does not exceed the limits set by OSHA standards. If your employer provides respirators for your voluntary use, or if you provide your own respirator, you need to take certain precautions to be sure that the respirator itself does not present a hazard.



You should do the following:

1. Read and heed all instructions provided by the manufacturer on use, maintenance, cleaning and care, and warnings regarding the respirators limitations.
2. Choose respirators certified for use to protect against the contaminant of concern. NIOSH, the National Institute for Occupational Safety and Health of the U.S. Department of Health and Human Services, certifies respirators. A label or statement of certification should appear on the respirator or respirator packaging. It will tell you what the respirator is designed for and how much it will protect you.
3. Do not wear your respirator into atmospheres containing contaminants for which your respirator is not designed to protect against. For example, a respirator designed to filter dust particles will not protect you against gases, vapors, or very small solid particles of fumes or smoke.
4. Keep track of your respirator so that you do not mistakenly use someone else's respirator.

[63 FR 1152, Jan. 8, 1998; 63 FR 20098, April 23, 1998]

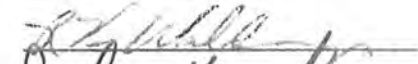

Substance Abuse and Prevention (Non-DOT)

Effective Date	<u>January 11, 2012</u>		
Revision Date	<u>December 31, 2011</u>		
Approval		Date	<u>1/11/12</u>
Approval		Date	<u>1/11/12</u>

Lehigh Hanson
HEIDELBERGCEMENT Group

Title	Substance Abuse and Prevention
Number	HR-US 2-005 Non-DOT
Approval Date	January 11, 2012
Revision Date	December 31, 2011

General Policy Statement:

Lehigh Hanson is committed to protecting the safety, health and well-being of all employees, customers and the general public. This policy will serve to inform employees of the requirements of Lehigh Hanson's drug-free workplace standards, and provide information regarding the Company's Employee Assistance Program (EAP). A Union-supported EAP will be used where directed by collective bargaining agreements.

Lehigh Hanson encourages employees to voluntarily seek assistance with drug and alcohol problems and to utilize the *Employee Assistance Program* (EAP) before those problems affect their workplace performance.

It is the policy of Lehigh Hanson that prohibited behaviors during working hours, while operating company vehicles /equipment, on Company property, or being at work/job site with the detectable presence of a controlled substance or alcohol (*see Appendix 1*) will include but not be limited to;

- 1.) Manufacture, distribution, possession, or use of illegal drugs
- 2.) Manufacture, distribution, possession, or use of alcohol (possession of sealed alcohol temporarily stored in personal or company vehicles and offices is allowed as applicable with state or local law).
- 3.) Improper or unreported use of prescription drugs that in any way could affect job performance.

Any employee that violates this Policy will be subject to disciplinary action up to and including termination of employment. Any employee of a contractor or vendor, or any guest or visitor to a work site who violates any provision of this Policy will be removed and prohibited from any future access to Company property.

Scope of Policy:

1. This Policy applies to all employees of Lehigh Hanson, including hourly, salaried, temporary, full-time, and part-time; all employees of contractors and vendor companies; and all visitors and guests.
2. At Lehigh Hanson employees who are currently represented by organized labor will be subject to the terms and conditions of the applicable collective bargaining agreements.
3. Lehigh Hanson expressly reserves the right to conduct searches as defined in the company's *Inspection and Searches policy HR-US 2-009*, where applicable.
4. Refusal to cooperate in either the testing procedures outlined in this Policy or in the procedures defined in the *Inspection and Searches policy HR-US 2-009* will be considered a violation of the policies which could result in the employee being disciplined up to and including termination.
5. Job advertisements/postings will include the phrase "A Drug Free Workplace."

Requirements and Prohibitions:

1. Employees are required to report to work free from impairment resulting from the on- or off-duty use of alcohol or other drugs.
2. An employee's decision to voluntarily seek assistance for drug and alcohol problems is encouraged and will not be used as the basis for disciplinary action. Voluntarily seeking assistance after cause for testing under the parameters of this policy will not lessen any disciplinary action. Employees who fail to complete treatment and/or rehabilitation, and all prescribed after care, will be subject to disciplinary action up to and including termination of employment.
3. Any employee whose job requires operating a company vehicle who is arrested for a drug or alcohol-related offense must report the arrest to his/her supervisor prior to the start of their next regularly scheduled work shift. The Company may suspend without pay an employee arrested for a drug or alcohol-related offense, including suspension through resolution of charges. Failure to report the arrest is cause for discipline up to and including termination of employment.
4. To meet the requirements of the "Drug Free Workplace Act" of 1988, all employees convicted of an offense involving alcohol or illegal drugs, must notify the Company within five (5) days after his or her conviction, and will be subject to disciplinary action up to and including termination of employment. A conviction will also include any plea agreement entered into by the employee for a reduced charge or sentence.
5. While the proper use of prescribed drugs is not a violation of Company policy, employees who are taking prescribed medication and/or over-the-counter medication that can cause drowsiness, that may impair their ability to operate equipment or machinery, or that have other potentially hazardous side effects must report the prescription drug use or use of over-the-counter medication to their supervisor and/or management in writing prior to engaging in work (see *Appendix 2*). Failure to report such drug use to management will be grounds for disciplinary action.

Shared Responsibilities:

The Company will comply with unique State Drug Testing Statutes where required, and ensure the accuracy, fairness and consistency of our testing program. All testing will be conducted according to Substance Abuse and Mental Health Services Administration (SAMHSA) and U.S. Department of Health and Human Services (DHHS) guidelines where applicable.

The Company will provide supervisors/managers with education and training in substance abuse detection, documentation, and intervention.

The Company will provide one (1) or more Designated Employer Representative(s) (DER) as the contact person for each Region (see *Appendix 3*). The DER will be responsible for implementation and administration of the Substance Abuse and Prevention program including liaison with any contractor, vendor, or counseling group selected to assist in program administration. The DER will secure an approved specimen collection site(s) to provide services in those situations where specimens are to be collected off premises. The DER will arrange for the implementation of supervisory training in the detection of symptoms of possible drug/alcohol abuse.

Supervisor/Manager will be responsible for distributing the Substance Abuse and Prevention policy, obtaining acknowledgement forms from current and newly hired employees, and ensuring all employees are aware of the consequences of prohibited drug and alcohol use.

Supervisor/Manager will be responsible for observing the performance and behavior of employees and all other persons entering the property and applying his/her training in detection of possible symptoms of drug / alcohol use or impairment.

Supervisor/Manager, or designee, will accompany the employee to the appropriate collection site for all reasonable cause testing (including post accident) within the specified time period as outlined in Testing Procedures, and will verify the employee's identity when an employee does not have photograph identification for presentation at the collection site.

Supervisor/Manager will intervene and remove an employee from his/her duties when an employee voluntarily comes forward admitting a drug or alcohol problem and/or seeking assistance. If an employee comes forward prior to a qualifying event that would subject the employee to alcohol or drug testing under the conditions of this policy, then a Management Referral to the EAP may be provided.

All current and newly hired employees must sign a consent form (*see Appendix 5*) and are responsible for complying with prohibitions related to illegal substances and must provide an unadulterated specimen at a designated collection site, at an assigned time, when requested to do so under this program. All contractors, supplier, customers, visitors, etc. must be informed and comply with provisions of the Drug Free Workplace Act of 1988.

Employees must provide any requested information on a Custody and Control Form and sign the form. Failure to do so or failure to otherwise cooperate with collection personnel will result in disciplinary action up to and including termination of employment. Refusal to provide the specimen will be considered equivalent to failing a drug/alcohol test. Employees are also responsible for reporting medical information (e.g., other prescription or over-the-counter medications recently taken), if such information is requested by the Medical Review Officer (MRO), if applicable, after he/she receives the test result.

Conditions for Drug and Alcohol Testing:

The conditions for drug and alcohol testing in this policy apply to Lehigh Hanson employees not subject to DOT regulations. Any DOT employee not performing DOT functions will be subject to this policy.

Pre-Employment

1. A pre-employment drug test will be conducted and results received before an individual may report to duty. Offers of employment will be retracted if an applicant's test results reveal the presence of a prohibited substance or derivative thereof. Applicants who test positive may not reapply for employment with Lehigh Hanson, or any subsidiary thereof, for a period of one (1) year.

Random

1. The purpose of random testing is to deter prohibited drug and alcohol use and to ensure a drug and alcohol-free workplace. All Lehigh Hanson employees will participate in the random testing program, as applicable with state and local laws.
2. Random testing will be unannounced, confidential, and conducted on a frequency and percentage rate determined annually. In addition, each employee not otherwise tested under the provisions of this policy may be subject to testing no less than once per twenty-four (24) month period.
3. Employees shall be selected for testing by using a computer-based random number generator or equivalent random selection method that is matched with an employee's social security number or employee ID number. Alternatively, some areas may choose to randomly select sites and test all employees at these sites.
4. The appropriate manager/supervisor will notify the employee to be tested:
 - a. The employee will not be notified of the test until after reporting for duty.
 - b. Once notified, the employee shall report immediately to the collection site within 30 minutes, plus travel time.
 - c. The employee will be paid for any time spent to perform the random test.

5. Employees who have been terminated under the provisions of this policy may not reapply for employment with Lehigh Hanson, or any subsidiary thereof, for a period of one (1) year.

Reasonable Cause

1. The company will require an employee, or group of employees, to submit to a drug and/or alcohol test when there is reasonable suspicion to believe that the employee(s) has violated the drug use and/or alcohol use prohibitions of this policy.
2. Employees who have been terminated under the provisions of this policy may not reapply for employment with Lehigh Hanson, or any subsidiary thereof, for a period of one (1) year.
3. A Manager's determination that reasonable suspicion exists must be based on specific observations that can be articulated concerning the appearance, behavior, speech, or body odors of the covered employee. These observations must be documented by the trained Manager/Supervisor and a second trained witness, and must remain confidential. (see Appendix 4).
4. The DER must be notified prior to conducting any testing and provided a copy of the signed documentation (see Appendix 4).
5. The potentially affected employee(s) will not be allowed to proceed alone to or from the collection site. In order to ensure employee and public safety, the employee(s) will be instructed not to drive any motor vehicle due to the reasonable belief that(s) he may be under the influence. The company will take measures to ensure the employee is provided transportation up to and including notifying local law enforcement officials.
6. After returning from the collection site, the employee should not be allowed to return to work pending the results of the drug test. This time away from work will be considered a suspension without pay. Any lost wages will be paid if the resulting test results are negative.

Post-Accident

1. All employees involved in an accident during work hours, during a company sponsored event, and/or operating company equipment, will be subject to a post-accident drug/alcohol test when:
 - a. At least one person is injured and requires off-site medical treatment and/or the accident (medical or not) is reportable to a Federal or State agency.
 1. In a case where an employee is injured as a result of another employee's negligence, both employees will be requested to submit to a drug/alcohol screen.
 - b. Any accident that causes damage to a vehicle, equipment, materials or supplies owned by the company (damage value to be determined by local business practice).
 - c. If there is reasonable suspicion as a result of the accident, refer to Reasonable Cause above.
2. An employee who is subject to post-accident drug/alcohol testing shall remain readily available for such testing or may be deemed by the company to have refused to submit to testing.

Return to Work - Follow-Up

1. An employee returning to work after a leave of absence of 45 calendar days or longer may be required to submit to a drug and alcohol test prior to performing work duties in accordance with the (*Return To Work Policy HR-US 3-008*).
2. A leave of absence will include but not be limited to the following:
 - a. A personal illness, or leave of absence of any kind.
 - b. A work-related injury.
 - c. Return from layoff including seasonal layoffs that extend 45 calendar days or longer.
3. As a condition of continued employment, any employee returning to work after a management referral to the EAP for substance abuse treatment, counseling or rehabilitation will be subject to periodic drug and/or alcohol testing, without prior notice, for a predetermined period of time after his or her return to duty.
4. Employees who have been terminated under the provisions of this policy may not reapply for employment with Lehigh Hanson, or any subsidiary thereof, until supporting documentation of completion of a Substance Abuse Program and agreement to terms and conditions of employment have been received.

Testing Procedures:

Alcohol Testing

1. Breath and/or Saliva testing may be used for the initial alcohol test however, when confirming quantitative data about the alcohol concentration, testing will be performed using an Evidential Breath Testing Device (EBT) and administered by a Breath Alcohol Technician (BAT). These are the results for which any action under operating administration rules shall be based.
2. Each employee subject to a post-accident alcohol test shall be required to submit to the alcohol test within two (2) hours of the accident. If an alcohol test is not administered within two (2) hours following the accident, the supervisor/manager shall prepare and maintain on file a record stating the reason(s) the test was not promptly administered. If a test is not administered within eight (8) hours following the accident, the supervisor/manager shall cease all attempts to conduct an alcohol test and shall prepare and maintain on file written documentation indicating why the alcohol test was not conducted (see Appendix 4).
3. An employee with a confirmed positive alcohol test result will be removed from his/her duties for no less than twenty-four (24) hours without pay and subject to disciplinary action up to and including termination of employment in accordance with the (*Progressive Discipline Policy HR-US 2-004*).
4. An employee with a verified positive alcohol test result equal to 0.04 or greater that is subject to Commercial Drivers License (CDL) requirements per 49 CFR Part 383 and who operates a commercial motor vehicle in interstate or intrastate commerce may not perform any DOT safety-sensitive duties (see *Substance Abuse and Prevention Policy HR-US 2-005 DOT, Appendix 2*) unless they have successfully completed the Substance Abuse Professional evaluation, referral and education/treatment process set forth in Part 40, Subpart O of the FMCSA regulations.

Drug Testing

1. Employees of Lehigh Hanson will be tested under a ten (10) panel drugs and metabolites protocol which includes: amphetamines, barbiturates, benzodiazepines, cocaine metabolite, opiates, phencyclidine, marijuana metabolite, methadone, methaqualone, and propoxyphene. All drug testing will be performed using SAMHSA approved testing facilities.

THE DRUGS IN THIS PROFILE ARE SCREENED BY IMMUNOASSAY. ANY POSITIVE RESULT IS CONFIRMED BY GAS CHROMATOGRAPHY WITH MASS SPECTROMETRY (GC/MS). THE FOLLOWING THRESHOLD CONCENTRATIONS ARE USED FOR THIS ANALYSIS:

DRUG	SCREENING THRESHOLD	CONFIRMATION THRESHOLD
AMPHETAMINES	1000 NG/ML	500 NG/ML
BARBITURATES	300 NG/ML	300 NG/ML
BENZODIAZEPINES	300 NG/ML	300 NG/ML
COCAINE METABOLITE	300 NG/ML	150 NG/ML
OPIATES	2000 NG/ML	2000 NG/ML
PHENCYCLIDINE	25 NG/ML	25 NG/ML
MARIJUANA METABOLITE	50 NG/ML	15 NG/ML
METHADONE	300 NG/ML	300 NG/ML
METHAQUALONE	300 NG/ML	300 NG/ML
PROPOXYPHENE	300 NG/ML	300 NG/ML

2. Testing procedures will include a screening test; a confirmation test; the opportunity for a split sample; review by a Medical Review Officer (MRO), including the opportunity for employees who test positive to provide a legitimate medical explanation, such as a physician's prescription for the positive result; and a documented chain of custody. All drug-testing information will be maintained in confidential files.

3. A Chain-of-Custody (COC) procedure will be followed to account for the integrity of each urine specimen by tracking its handling and storage from point of specimen collection to final disposition of the specimen. These procedures shall require that an appropriate drug testing custody form from a Department of Health & Human Services (DHHS) certified laboratory be used from time of collection to receipt by the laboratory, and include a split sample specimen.
4. All employees subject to a post-accident drug test shall be required to submit to the drug test as soon as practicable following the accident. If the drug test is not conducted within 32 hours following the accident, the supervisor/manager shall cease attempts to administer the test and will prepare and maintain on file a record stating the reason why the test was not promptly administered (see Appendix 4).
5. A positive drug test result on an initial test will be confirmed by a second examination of the sample utilizing Gas Chromatography/Mass Spectrometry (GC/MS) and verified by a Medical Review Officer (MRO).
6. Before any action is taken concerning an employee, the MRO will notify the employee of the positive test result and allow an explanation for the presence of certain drugs. Any employee testing positive for illegal drugs will be dismissed without pay for that day and until completion of the MRO review. Any employee testing positive for illegal drugs will be subject to disciplinary action up to and including termination of employment.
7. An employee with a verified positive drug test result that is subject to Commercial Drivers License (CDL) requirements per 49 CFR Part 383 and who operates a commercial motor vehicle in interstate or intrastate commerce may not perform any DOT safety-sensitive duties (see *Substance Abuse and Prevention Policy HR-US 2-005 DOT, Appendix 2*) unless they have successfully completed the Substance Abuse Professional evaluation, referral and education/treatment process set forth in Part 40, Subpart O of the FMCSA regulations.
8. Any employee with a confirmed positive drug test result will be subject to disciplinary action up to and including termination in accordance with the (*Progressive Discipline Policy HR-US 2-004*).
9. An employee that submits an adulterated urine sample for testing (found to contain a substance that is not a normal constituent or contains an endogenous substance at a concentration that is not a normal physiological concentration) will be in violation of this policy and subject to disciplinary action up to and including termination of employment in accordance with the (*Progressive Discipline Policy HR-US 2-004*).
10. If an employee submits a urine sample and the specific gravity value is so diminished (diluted) that it is not consistent with normal human urine, and the sample is not deemed by the collection site as being adulterated, then the employee will be required to resubmit a specimen under direct observation by a same gender collection technician. Failure to cooperate or resubmit will be in violation of this policy and subject to disciplinary action up to and including termination of employment. in accordance with the (*Progressive Discipline Policy HR-US 2-004*). If the observed collection results in a second negative-dilute, which is not deemed to be adulterated, the result will be certified as negative.
11. Should an employee believe an error has occurred during the drug analysis of his or her provided sample, they can request, at his or her own expense that the split sample be retested. This provision does not apply to pre-employment sampling.

Any questions regarding interpretation of this policy should be directed to the Designated Employer Representative (DER) (Appendix 3) in your Region or to the appropriate Human Resource department.

All Federal and State Regulations, Company Policies, Programs and Appendixes referenced in this document will be made available at each facility/location and upon request.



Appendix 1

Illegal Substances Defined

A. *Illegal Substances*

Illegal substances, illicit or controlled substances, mind altering chemicals include, but may not be limited to:

1. Alcohol
2. Amphetamines
3. Barbiturates
4. Benzodiazepines
5. Cocaine
6. Ecstasy (MDMA)
7. Inhalants
8. LSD
9. Marijuana
10. Methamphetamine
11. Methadone
12. Methaqualone
13. Opiates
14. Oxazepam
15. PCP
16. Propoxyphene
17. Prescriptions written for other than the employee
18. Expired prescriptions
19. Other designer or look alike substance
20. Any drug which can impair full functioning ability

B. *Contraband Items*

Contraband items include, but are not limited to:

1. Drug related paraphernalia
2. Drug delivery systems

Post on Bulletin Board



Appendix 2

Employee Notification of Medications

Please Print the Following Information

Employee's Name: _____ Date: _____

EE's SSN: _____ Treating Physician: _____

This is to comply with Lehigh Hanson's Substance Abuse Policy. This is to certify that the above named patient is currently taking prescription medication (Do not list medications.)

This medication may impair his/her ability to perform job specific tasks in a safe manner.

Dates employee will be taking medication(s):		Type of impairment from this medication(s):
From: _____	To: _____	_____
From: _____	To: _____	_____
From: _____	To: _____	_____
From: _____	To: _____	_____
From: _____	To: _____	_____

Physician's Signature

Date



Appendix 3

Substance Abuse and Prevention Personnel and Services

Designated Employer Representative(s) (DER)

Region: Lehigh Hanson North (Northeast Sub-region – NY, PA, MD, NJ, RI, VA, NC, MA)
Name: Leonard Ewing
Address: 7660 Imperial Way, Allentown, PA 18195
Phone: 610-366-4672

Region: Lehigh Hanson North (Midwest Sub-region – KY, OH, IN, IL, MN, IA, ND)
Name: George Henley
Address: 181 West Madison Street, Suite 1800, Chicago, IL 60602
Phone: 312-443-6722

Region: Lehigh Hanson South
Name: Gordon Yonz
Address: 300 East John Carpenter Freeway, Irving, TX 75062
Phone: 972-653-6049

Region: Lehigh Hanson West
Name: Chery Hurst
Address: 9229 Harris Plant Road, San Diego, CA 92145
Phone: 858-715-5667

Region: Lehigh Hanson Building Products
Name: Christine Crockett
Address: 300 East John Carpenter Freeway, Irving, TX 75062
Phone: 972-653-3718

Region: Lehigh Hanson Canada Region, Washington State
Name:
Address:
Phone:

Medical Review Officer (MRO - CMI)

Name: RAYMOND G. ARMSTRONG, M.D.
Address: 6704 GUADA COMA , SCHERTZ, TX 78154
Phone: (210) 967-6169

Medical Review Officer (MRO - DTN)

Name: Dr. Alfred Quinonez
Address: (958) Postal Way, Ste. 6-B; Vista, CA 92083
Phone:

SAMHSA Laboratory - CMI

Lehigh Hanson
HEIDELBERGCEMENT Group

Name: MEDTOX LABORATORIES, INC.
Address: 402 W COUNTY RD D, SAINT PAUL, MN 55112-3522
Phone: (800) 832-3244

SAMHSA Laboratory - DTN

Name: Quest Diagnostics
Address: 8401 Fallbrook Ave., Level 2; West Hills, CA. 91304
Phone: (800) 877-7484

Collection Sites(s) – Resource/Locator Service

Name: CMI
Address: 6704 GUADA COMA, SCHERTZ, TX 78154
Phone: (800) 840-1070

Various collection sites may be utilized. Each collection site will be evaluated to ensure it meets the criteria required to act as an approved site.

Collection Sites(s) – Resource/Locator Service

Name: DTN
Address: 958 Postal Way, Ste 6-B; Vista, CA 92083
Phone: (800) 989-1206

Various collection sites may be utilized. Each collection site will be evaluated to ensure it meets the criteria required to act as an approved site.

Breath Alcohol Technician (BAT) / Screening Test Technician (STT) Resource/Locator Service

Name: CMI
Address: 6704 GUADA COMA, SCHERTZ, TX 78154
Phone: (800) 840-1070

Breath Alcohol Technician (BAT) / Screening Test Technician (STT) Resource/Locator Service

Name: DTN
Address: 958 Postal Way, Ste. 6-B; Vista, CA 92083
Phone: (800) 989-1206

DOT Approved Evidential Breath Testing Devices (EBTS) Utilized

Consortium/Third Party Administrator (C/TPA)

Name: CMI
Address: 6704 GUADA COMA, SCHERTZ, TX 78154
Phone: (800) 840-1070

DOT Approved Evidential Breath Testing Devices (EBTS) Utilized

Consortium/Third Party Administrator (C/TPA)

Name: DTN
Address: 958 Postal Way, Ste. 6-B; Vista, CA 92083
Phone: (800) 989-1206

Employee Assistance Program (EAP)

Region: Lehigh Hanson, Inc. - All Regions
Name: Aetna Employee Assistance Program
Phone: (888) 238-6232

Lehigh Hanson
HEIDELBERGCEMENT Group

Substance Abuse Professional – SAP Referrals

Name: CMI
Address: 6704 GUADA COMA, SCHERTZ, TX 78154
Phone: (800) 840-1070

Substance Abuse Professional – SAP Referrals

Name: DTN
Address: 958 Postal Way, Ste. 6-B; Vista, CA 92083
Phone: (800) 989-1206



Appendix 4

Drug/Alcohol Testing Supervisor Written Record

(This form is to be used only for the two (2) conditions for testing Listed below)

Employee's Name: _____ Date: _____

Location: _____ Time of Incident: _____

1. Post-Accident Testing – Reason for not testing

- a. Alcohol testing not completed within two (2) hours of accident because:

- b. Alcohol Testing not completed within eight (8) hours of accident because:

- c. Drug testing not completed within 32 hours of accident because:

2. Reasonable Cause Testing Observation

This checklist is to be completed when an incident has occurred which provides reasonable suspicion that an employee or group of employees may be under the influence of alcohol or drugs. The supervisor(s) should note all pertinent behavior, physical signs or symptoms and any circumstances which lead to your reasonable suspicion that the employee(s) may have recently used, or may be under the influence of, a prohibited substance. Mark each applicable item on this form and any additional facts or circumstances which you have noted.

A. Nature of Incident/Cause for Suspicion

- Observed/reported possession or use of a prohibited substance
- Apparent drug or alcohol intoxication
- Observed abnormal or erratic behavior
- Evidence of tampering on a previous drug test
- Other (e.g., flagrant violation of safety or serious misconduct, accident, incidents, fighting or argumentative/abusive language, refusal of supervisor instruction, unauthorized absence on the job). Please specify _____

Lehigh Hanson
HEIDELBERGCEMENT Group

B. Unusual Behavior

- Verbal abusiveness
- Apparent drug or alcohol intoxication
- Extreme aggressiveness or agitation
- Withdrawal, depression, mood changes, or unresponsiveness
- Inappropriate verbal response to questioning or instructions
- Other erratic or inappropriate behavior (e.g., hallucinations, disoriented, excessive euphoria, talkativeness, confused). Please specify.

C. Physical Signs or Symptoms

- Possessing, dispensing, or using prohibited substance
- Slurred or incoherent speech
- Unsteady gait or other loss of physical control, poor coordination
- Dilated or constricted pupils or unusual eye movement
- Bloodshot or watery eyes
- Extreme fatigue or sleeping on the job
- Excessive sweating or clamminess of the skin
- Flushed or very pale face
- Highly excited or nervous
- Nausea or vomiting
- Odor of alcohol
- Odor of Marijuana
- Dry mouth (frequent swallow/lip wetting)
- Dizziness or fainting
- Shaking hands or body tremors/twitching
- Breathing irregularly or difficulty breathing
- Runny nose or sores around nostrils
- Inappropriate wearing of sunglasses
- Puncture marks or "tracks"
- Other (Please specify)

Lehigh Hanson
HEIDELBERGCEMENT Group

D. Written Summary

Please summarize the facts and circumstances of the incident, employee response, supervisor actions taken, and any other pertinent information not previously noted. Please note the date, times and location of reasonable cause testing or note if employee refused test. Attach additional sheets as needed.

Reasonable Cause Testing Observation - Reason for not testing.

a. Alcohol testing not completed within two (2) hours of the determination because:

b. Alcohol testing not completed within eight (8) hours of the determination because:

c. Drug testing not completed within 32 hours of the determination because:

Signature of Supervisor #1 Date Time

Signature of Supervisor #2 Date Time

Lehigh Hanson
HEIDELBERGCEMENT Group

Appendix 5

New Hire Consent Form

Job Applicant: _____

I hereby consent to supplying a sample for a drug and alcohol test. I understand that results from this test will be used in evaluating my application for employment. I also understand that if I am employed by Lehigh Hanson, I may be asked to undergo testing if I am involved in a work-related accident; if I exhibit behavior which gives the employer reasonable cause to believe that I might be impaired on the job; if my employer has another reason to believe I may be impaired; or at unannounced periodic times. It is a condition of any employment, which I might be offered with Lehigh Hanson, that I consent to such testing if I accept an offer of employment. I hereby agree that if I receive an offer, I do accept this condition of employment.

Signature

Date

Section P.4

Continental Florida Materials Lehigh Hanson Frequency of Training

Training Task	Training Frequency
Basic Electrical Safety	Annual
Blood Borne Pathogens	Annual
Confined Spaces (PRCS)	Annual
Emergency Response Plan	Annual
Fire Protection	Annual
Hazard Communication	Annual
Lock Out / Tag Out	Annual
Machine Guarding	Annual
Personal Protective Equipment (PPE)	Annual
Respiratory Protection	Annual
Aerial Man-lift Safety	3 year
Back Safety	Annual
Compressed Gas Safety	Annual
Cutting and Welding Safety	Annual
Electrical Safety High/Low Voltage Training	Annual
Excavator Operation	3 year
Earthmoving Equipment	3 year
Fall Protection	Annual
Front End Loader Operation	3 year
General Hand Tools	Annual
Ladder Safety	Annual
Powered Industrial Trucks	3 year
Rigging Safety	Annual
Skid-steer (Bobcat) Operation	3 year
Walking and Working Surfaces	Annual
CPR	2 year
Crane/Hoist Safety	Annual
Facility Security Plan (FSP)	Annual
First Aid	2 year
OSHA 501 Trainer Course	3 year
OSHA 511 Trainer Course	3 year

Section Q

- a) Broward County Environmental Protection and Growth Management Department
- b) Issued on 8/10/2018
- c) Excessive visible emissions were observed originating from the ship unloading operations at the Port Everglades facility.
- d) Please refer to attached letters.
- e) Closure letter closing out the warning letter is forthcoming.
- f) None to date and none are expected.
- g) The following revised set of corrective actions was mailed to the County on 12/21/18.

1. Daily monitoring of Unloading and Control System:

- a. Water fogging system is started before any start of unloading operations and stays in operation during the entire unloading operations. Inspection records are completed and reviewed.
- b. Routine inspections while the unloading system is in operation of all key unloading and control systems (such as fogging system, covered conveyor, screw conveyors, and associated baghouses) are occurring. Inspection records are completed and reviewed.
- c. Training and Clear communication has been conducted regarding the requirement that unloading operations will be stopped immediately in the event of any equipment malfunction causing increased emissions.

2. Pavement of certain Facility areas:

- a. Sweeper is being operated to minimize any fugitive dust emissions. A Log is completed and reviewed to validate its operation.
- b. Unpaved areas are being watered by hand during high wind conditions until we complete the engineering, approval and installation of additional paving.
- c. We have engaged an engineering group to perform necessary water shed surveys and concrete designs for Port Authority's approvals regarding additional paving.

3. Belt Conveyor Controls:

- a. Two portable dust collectors have been purchased and installed on the material transfer belt conveyor to minimize any fugitive dust emissions. These dust collectors are started before any start of unloading operations and stays in operation during the entire unloading operations. Inspection records are completed and reviewed.
- b. Entire belt conveyor is enclosed with tarps to minimize any fugitive dust emissions. Tarps are inspected daily, and any needed repairs are made immediately. Inspection records are completed and reviewed.

4. Vessel unloading controls:

- a. We have worked with the Port Authority and Ship Owners to have the Ships turned after unloading of approximately ½ of the Ship hold to allow access to both sides of the hold. Access to both sides of the ship provides the ability to minimize potential for "high walls" of material from "sluffing" and minimize any fugitive dust emissions.
- b. We are working to get agreement to turn the ships as part of our ship nomination with the ship owners.

5. Improvement to the Fogging System:

- a. We are working with the manufacturer of the fogging system for any further recommendations for improvements.

4. We are confident that these corrective actions will continue to address the concerns sustainably. We are continuing to work with County and will provide next update by April 1, 2019. CFM is committed to operating our facility in compliance with our permit requirements.



Environmental Protection and Growth Management Department
ENVIRONMENTAL ENGINEERING AND PERMITTING DIVISION
One North University Drive, Suite 102-A, Plantation, Florida 33324
954-519-1483 · FAX 954-519-1412

WARNING NOTICE

Page 1 of 2

WARNING NOTICE NUMBER: WRN18-0202

Pursuant to Chapter 27 of the Broward County Code of Ordinances ("Code" or "BCC"), the Environmental Protection and Growth Management Department (Department) has the authority and duty to control and regulate activities and facilities which adversely affect the air, water, soil and other natural resources of Broward County.

The Department certifies that it has just grounds to believe that on or about July 16, 2018, at the location below, the following Respondent(s) was/were in violation of the sections of the Broward County Code identified in each count:

Location: 2600 EISENHOWER BLVD
Fort Lauderdale, FL 33316

COUNT 1: Respondent: Continental Florida Materials, Inc. (Lehigh Cement)

Violated Section 27-175(h), BCC, which states:

"... No person shall cause, let, permit, suffer, or allow the emissions of particulate matter, from any source whatsoever, including but not limited to vehicular movement, transportation of materials, construction, alteration, demolition or wrecking, or industrial related activities such as loading, unloading, storing, handling, surface coating, or surface preparation without taking reasonable precautions to prevent such emission, as described in Subsection 27-177(b) of this article."

By: Causing, permitting, suffering or allowing ship unloading operations to generate significant unconfined emissions which are adversely impacting neighboring Port Everglades operations in violation of Air permit 0111012-006-AF, Section 3, Facility Wide Condition 5, Unconfined Emissions of Particulate Matter, which states: 1. No person shall cause, let, permit, suffer or allow the emissions of unconfined particulate matter from any activity, including vehicular movement; transportation of materials; construction, alteration, demolition or wrecking; or industrially related activities such as loading, unloading, storing or handling; without taking reasonable precautions to prevent such emissions.

Corrective Action:

Respondent shall:

- 1) Immediately correct or halt situations that endanger public health or the environment.
- 2) Within thirty (30) days of receipt of this notice, submit to this office a corrective plan of action to contain unconfined emissions within property boundary and prevent impact to surrounding areas.

Correct within 30 day(s) of service of this notice.

WARNING NOTICE NUMBER: WRN18-0202

Page 2 of 2

Accordingly, the Respondent(s) is/are hereby advised to correct and respond to the aforesaid allegation(s) within the time period identified in each count above, or by advising the Department of any circumstances which it believes make this/these allegation(s) inapplicable.

Failure to comply with this Warning Notice may result in the issuance of a Notice of Violation and a Notice of Hearing to Assess a Civil Penalty. Pursuant to a Notice of Violation, a Civil Penalty in an amount up to \$15,000.00 per violation per day may be levied by a Hearing Examiner.

Your response or any questions concerning this Warning Notice should be directed to Art Pennetta at phone: (954) 519-1428, FAX: (954) 519-1495 or email: apennetta@broward.org.

Issued By: W. Gail Custode, Senior Program Coordinator
Enforcement Administration
Environmental Engineering and Permitting Division
Issued Date: 08/10/2018

Registered Agent/Mailed To:

Corporation Service Company
(for Continental Florida Materials, Inc. (Lehigh Cement))
1201 Hays Street
Tallahassee, FL 32301-2525
RRR: 7016 2070 0000 2851 5985



Environmental Protection and Growth Management Department
ENVIRONMENTAL AND CONSUMER PROTECTION DIVISION
ENVIRONMENTAL ENFORCEMENT
1 N. University Drive, Ste. 307
Plantation, FL 33324

REGISTERED MAIL

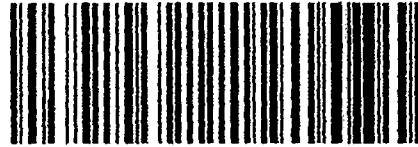

7016 2070 0000 2851 5985



U.S. POSTAGE » PITNEY BOWES

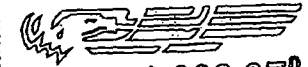

ZIP 33172 \$ 006.67⁰
02 4W
0000355754 AUG. 14. 2018

Corporation Service Company
(for Continental Florida Materials, Inc.)
1201 Hays Street
Tallahassee, FL 32301-2525

32301 32608 0005

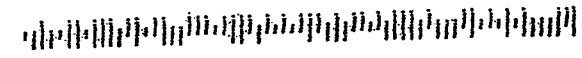



**Continental Florida Materials, Inc.
Port Everglades Terminal
2600 Eisenhower Blvd.
Fort Lauderdale, FL 33316**

December 21, 2018

Mr. Art Pennetta, Compliance Manager
Broward County Environmental Protection and Growth Management Department
Environmental Engineering & Permitting Division
One North University Drive, Mailbox 201
Plantation FL 33324

Re: Follow-up to September 7, 2018 response to Broward County Notice No. WRN18-0202
Continental Florida Materials, Inc. – Port Everglades Terminal
2600 Eisenhower Blvd, Fort Lauderdale, FL 33316
Air Operation Permit No. 0111012-006-AF

Dear Mr. Pennetta:

Thank you for taking time to come to our facility on December 17, 2018, to review the corrective action(s), as detailed in our September 7, 2018 response, that we have instituted to contain unconfined emissions within property boundary and prevent impact to surrounding areas.

There have been no complaints in the last two (2) months, and we believe that our instituted corrective action(s) along with collaborative work with your Department and Port Authority are effective in sustainably addressing the concerns. We would request your review and approval to close out the Broward County Notice No. WRN18-0202.

Following are further details of the corrective action(s):

1. Daily monitoring of Unloading and Control System:
 - a. Water fogging system is started before any start of unloading operations and stays in operation during the entire unloading operations. Inspection records are completed and reviewed.
 - b. Routine inspections while the unloading system is in operation of all key unloading and control systems (such as fogging system, covered conveyor, screw conveyors, and associated baghouses) are occurring. Inspection records are completed and reviewed.
 - c. Training and Clear communication has been conducted regarding the requirement that unloading operations will be stopped immediately in the event of any equipment malfunction causing increased emissions.
2. Pavement of certain Facility areas:
 - a. Sweeper is being operated to minimize any fugitive dust emissions. A Log is completed and reviewed to validate its operation.
 - b. Unpaved areas are being watered by hand during high wind conditions until we complete the engineering, approval and installation of additional paving.

- c. We have engaged an engineering group to perform necessary water shed surveys and concrete designs for Port Authority's approvals regarding additional paving.
3. Belt Conveyor Controls:
 - a. Two portable dust collectors have been purchased and installed on the material transfer belt conveyor to minimize any fugitive dust emissions. These dust collectors are started before any start of unloading operations and stays in operation during the entire unloading operations. Inspection records are completed and reviewed.
 - b. Entire belt conveyor is enclosed with tarps to minimize any fugitive dust emissions. Tarps are inspected daily, and any needed repairs are made immediately. Inspection records are completed and reviewed.
4. Vessel unloading controls:
 - a. We have worked with the Port Authority and Ship Owners to have the Ships turned after unloading of approximately ½ of the Ship hold to allow access to both sides of the hold. Access to both sides of the ship provides the ability to minimize potential for "high walls" of material from "sluffing" and minimize any fugitive dust emissions.
 - b. We are working to get agreement to turn the ships as part of our ship nomination with the ship owners.
5. Improvement to the Fogging System:
 - a. We are working with the manufacturer of the fogging system for any further recommendations for improvements.

We are confident that these corrective actions will continue to address the concerns sustainably. We will keep you posted on our progress and will provide next update by April 1, 2019. CFM is committed to operating our facility in compliance with our permit requirements, and we appreciate us being able to work collaboratively with your Department.

Please call (502) 548-0538 (Cell) or email (paul.stewart@lehighhanson.com) for any further assistance.

Sincerely,

Paul Stewart

Paul Stewart
Director of Terminal Operations and Logistics

cc: Lalit Bhatnagar, Director – Environment, Safety & Health
Jack Garvey, Area Environmental Manager
Carlos Gonzalez, Port Everglades Terminal Manager



Continental Florida Materials, Inc.
Port Everglades Terminal
2600 Eisenhower Blvd.
Fort Lauderdale, FL 33316

September 7, 2018

Mr. Art Pennetta, Compliance Manager
Broward County Environmental Protection and Growth Management Department
Environmental Engineering & Permitting Division
One North University Drive, Mailbox 201
Plantation FL 33324

Re: Response to Broward County Notice No. WRN18-0202
Continental Florida Materials, Inc. – Port Everglades Terminal
2600 Eisenhower Blvd, Fort Lauderdale, FL 33316
Air Operation Permit No. 0111012-006-AF

Dear Mr. Pennetta:

Please accept this letter as our response to the abovementioned notice by your Department within thirty (30) days of service of this notice on September 17, 2018. Further, CFM has immediately instituted corrective action(s) detailed in your notice and have continued to work on the corrective plan of action to contain unconfined emissions within property boundary and prevent impact to surrounding areas.

Following are further details of the corrective plan of action:

1. Daily monitoring of Unloading and Control System - The facility unloads vessels utilizing a mechanical unloader manufactured by Siwertell. The company uses BACT (Best Available Control Technology) for dust control by operating a water fog generation system at the vessel that captures the dust particles as they rise above the cargo holds and by using land-based dust control equipment as necessary as the product is conveyed from the vessel to the storage silos. We will ensure use of the BACT equipment for unloading, and that all key unloading and control systems (such as fogging system, covered conveyor, screw conveyors, and associated baghouses) are inspected and maintained, to minimize or eliminate the unconfined emissions of particulate matter. Inspection records will be maintained. Unloading operations will be stopped by facility personnel in the event of any equipment malfunction causing increased emissions.
2. Pavement of certain Facility areas – While most areas of the facility are paved, we are working with Port Authority to further pave certain unpaved portions of the facility. We are continuing the use and upgrade frequency of dust suppression and sweeping service to minimize any fugitive dust emissions from our facility as needed.

We are confident that these corrective actions will address the concerns. However, we are further engaging an engineering company to review and address any improvements that we can make to our unloading and control system. We will keep you posted of our progress, also.

CFM is committed to operating our facility in compliance with our permit requirements and we appreciate us being able to work collaboratively with your Department.

Please call (502) 548-0538 (Cell) or email (paul.stewart@lehighhanson.com) for any further assistance.

Sincerely,

Paul Stewart
Director of Terminal Operations and Logistics

cc: Lalit Bhatnagar, Director – Environment, Safety & Health
Jack Garvey, Area Environmental Manager
Carlos Gonzalez, Port Everglades Terminal Manager



Environmental Protection and Growth Management Department
ENVIRONMENTAL AND CONSUMER PROTECTION DIVISION - ENFORCEMENT ADMINISTRATION
One N. University Drive, Mailbox 307, Plantation, FL 33324 954-519-1210 * FAX 954-519-1493

**NOTICE OF VIOLATION
and
NOTICE OF HEARING
TO ASSESS A CIVIL PENALTY**

NOTICE OF VIOLATION NUMBER: NOV19-0004

Page 1 of 3

The undersigned certifies that he/she has just grounds to believe that from August 14, 2017, to present, at the location below, the following Respondent(s) was/were in violation of the section(s) of the Broward County Code of Ordinances ("Code" or "BCC") identified in each count:

Location: 2600 EISENHOWER BLVD
Fort Lauderdale, FL 33316

**COUNT 1: Respondent: Continental Florida Materials, Inc. (Lehigh Cement)
Respondent: Lehigh Cement Company LLC**

Violated Section 27-175(h), BCC, which states:

"... No person shall cause, let, permit, suffer, or allow the emissions of particulate matter, from any source whatsoever, including but not limited to vehicular movement, transportation of materials, construction, alteration, demolition or wrecking, or industrial related activities such as loading, unloading, storing, handling, surface coating, or surface preparation without taking reasonable precautions to prevent such emission, as described in Subsection 27-177(b) of this article."

By: Causing, permitting, suffering or allowing ship unloading operations to generate unconfined particulate emissions without taking reasonable precautions to prevent such emissions in violation of Air Permit 0111012-006-AF, Section 3, Facility Wide Condition 5, Unconfined Emissions of Particulate Matter, which states: 1. No person shall cause, let, permit, suffer or allow the emissions of unconfined particulate matter from any activity, including vehicular movement; transportation of materials; construction, alteration, demolition or wrecking; or industrially related activities such as loading, unloading, storing or handling; without taking reasonable precautions to prevent such emissions.

NOTICE OF VIOLATION NUMBER: NOV19-0004

Page 2 of 3

IMPORTANT HEARING INFORMATION

There will be a Hearing held before the Broward County duly appointed Hearing Examiner at the following location:

**Broward County Government Center West
One North University Drive
Hearing Room - Second Floor
Plantation, Florida**

Date: April 25, 2019

Time: Hearings begin at 9:30 a.m. and continue until all cases on the docket are heard.

You may appear and present defenses to the violation(s) charged. The Hearing will take place whether or not you appear unless you make prior arrangements for continuance pursuant to section 27-31 of the Broward County Code. You may be represented by an attorney at the Hearing. After hearing the evidence, the Hearing Examiner may assess a Civil Penalty of up to \$15,000.00 per violation per day and may assess administrative costs associated with the Notice of Violation. You may request a Settlement Conference at least five (5) days prior to the scheduled Hearing to discuss compliance and the amount of penalty and costs to be assessed.

If you have any questions or wish to schedule a Settlement Conference, please contact Mark Gerberding at (954) 519-1481.

If, due to a disability, you require accommodation or auxiliary services to attend this Hearing or a Settlement Conference, please call to make a request within 48 hours of the Hearing or Conference.



John Stagnari,
Assistant Director

Date: 3/12/19

NOTICE OF VIOLATION NUMBER: NOV19-0004

Page 3 of 3

Registered Agent(s)/Mailed To:

Corporation Service Company
(for Lehigh Cement Company LLC)
1201 Hays Street
Tallahassee, FL 32301-2525
RRR: 7018 0680 0000 2302 8522

Corporation Service Company
(for Continental Florida Materials, Inc. (Lehigh Cement))
1201 Hays Street
Tallahassee, FL 32301-2525
RRR: 7018 0680 0000 2302 8515

C: Department of Environmental Protection, S.E. Florida District - West Palm Beach

Michael C. Owens, Assistant County Attorney

Sermin Turegun, Environmental Engineering and Permitting Division

Art Pennetta, Environmental Engineering and Permitting Division

No	Sub Item#	Date Issued	Date Abated	Location	Legal Entity	Standard	Description	Corrective Action
1	1A	5/18/2018	6/6/2018	Cupertino, CA	Lehigh Southwest Cement Company	3203(A)(6)	(6) Include methods and/or procedures for correcting unsafe or unhealthy conditions, work practices and work procedures in a timely manner based on the severity of the hazard: (A) When observed or discovered; and, (B) When an imminent hazard exists which cannot be immediately abated without endangering employee(s) and/or property, remove all exposed personnel from the area except those necessary to correct the existing condition. Employees necessary to correct the hazardous condition shall be provided the necessary safeguards.	All appropriate procedures and extensive training concerning safe practices in place. This citation has been appealed
	1B	5/18/2018	6/6/2018	Cupertino, CA	Lehigh Southwest Cement Company	6973(G)	(g) (18-20) (18-25) No employee shall be assigned, or allowed, or be required to perform work alone in any area where hazardous conditions exist that would endanger his safety unless he can communicate with others, can be heard, or can be seen.	All appropriate procedures and extensive training concerning safe practices in place. This citation has been appealed
	1C	5/18/2018	6/6/2018	Cupertino, CA	Lehigh Southwest Cement Company	7010(H)	(h) (9-26) Only authorized persons shall be present in areas of loading or dumping operations.	All appropriate procedures and extensive training concerning safe practices in place. This citation has been appealed
	1D	5/18/2018	6/6/2018	Cupertino, CA	Lehigh Southwest Cement Company	7012(H)	(h) The shovel, loader, dragline, or crane shall not be started to travel until it is first determined that the travel way is clear of persons and equipment.	All appropriate procedures and extensive training concerning safe practices in place. This citation has been appealed
2	2A	7/21/2017	8/16/2017	Techchapi, CA	Lehigh Southwest Cement Company	3328(G)	(g) Machinery and equipment in service shall be maintained in a safe operating condition.	Windshield wiper motor on maintenance truck was replaced.
	2B	7/21/2017	8/16/2017	Techchapi, CA	Lehigh Southwest Cement Company	4002(A)	a) All machines, parts of machines, or component parts of machines which create hazardous revolving, reciprocating, running, shearing, punching, pressing, squeezing, drawing, cutting, rolling, mixing or similar action, including pinch points and shear points, not guarded by the frame of the machine(s) or by location, shall be guarded.	Conveyor belt skirtboard guarding was provided.
3	3A	7/12/2017	7/24/2017	Cupertino, CA	Lehigh Southwest Cement Company	3273(I)	(I) Machines or equipment shall be located and guarded so that the product, waste stock, or material being worked or processed does not endanger employees.	Adequate guarding was provided to abate the hazard
	3B	7/12/2017	7/24/2017	Cupertino, CA	Lehigh Southwest Cement Company	3277(G)(4)	(4) Bottom of Cage. Cages shall extend down the ladder to a point not less than 7 feet nor more than 8 feet above the base of the ladder, with the bottom flared not less than 4 inches. When the ladder terminates on a landing platform or walkway at an elevation greater than 30 inches above the ground, a ladder cage extension shall be provided from the bottom of the cage to the top of the guardrail when the distance from the plane of the ladder rungs to the guardrail is equal to or less than that shown in Figure 11, "Ladder Cages at Elevated Locations."	Ladder cage was extended to meet the requirement
	3C	7/12/2017	7/24/2017	Cupertino, CA	Lehigh Southwest Cement Company	3340(C.)	(c) Classification of signs according to use. (1) Danger signs. (A) Danger signs shall be used only where an immediate hazard exists. (B) All employees shall be instructed that danger signs indicate immediate danger and that special precautions are necessary. (2) Warning signs. (A) Warning signs shall be used to indicate a potentially hazardous situation which, if not avoided, could result in death or serious injury. (B) All employees shall be instructed that warning signs indicate a potentially hazardous situation that could result in death or serious injury. (3) Caution signs. (A) Caution signs shall be used only to warn against potential hazards or to caution against unsafe practices. (B) All employees shall be instructed that caution signs indicate a possible hazard against which proper precaution should be taken.	Appropriate signage was provided.
	3D	7/12/2017	7/24/2017	Cupertino, CA	Lehigh Southwest Cement Company	3340(E.)	(e) Sign wordings. The wording of any sign shall be easily read and concise. The sign shall contain sufficient information to be easily understood. The wording shall make a positive, rather than negative suggestion and shall be accurate in fact.	Appropriate signage was provided.
4	4A	7/6/2015	8/8/2015	Wilmington, NC	Lehigh Northeast Cement Company	1910.147(C.)	Energy control procedure.	Written Energy Control (LOTOTO) procedures were implemented
	4B	7/6/2015	8/8/2015	Wilmington, NC	Lehigh Northeast Cement Company	1910.151(C.)	Where the eyes or body of any person may be exposed to injurious corrosive materials, suitable facilities for quick drenching or flushing of the eyes and body shall be provided within the work area for immediate emergency use.	Eye Wash station was provided.
5	5A	9/2/2015	3/21/2016	Cupertino, CA	Lehigh Southwest Cement Company	342(A)	(a) Every employer shall report immediately by telephone or telegraph to the nearest District Office of the Division of Occupational Safety and Health any serious injury or illness, or death, of an employee occurring in a place of employment or in connection with any employment.	Incident reporting procedures were updated and employees trained
	5B	9/2/2015	3/21/2016	Cupertino, CA	Lehigh Southwest Cement Company	3203(A)(4)(C)	(6) Include methods and/or procedures for correcting unsafe or unhealthy conditions, work practices and work procedures in a timely manner based on the severity of the hazard: (A) When observed or discovered; and	Workplace exam process was updated
	6A	1/9/2015	1/28/2015	Redding, CA	Lehigh Southwest Cement Company	4002(A)	(a) All machines, parts of machines, or component parts of machines which create hazardous revolving, reciprocating, running, shearing, punching, pressing, squeezing, drawing, cutting, rolling, mixing or similar action, including pinch points and shear points, not guarded by the frame of the machine(s) or by location, shall be guarded.	Platform was installed to access the ladder and a swing gate was installed at the top of the ladder.

6	6B	1/9/2015	1/28/2015	Redding, CA	Lehigh Southwest Cement Company	3212(A)(2)(A)	(2)(A) Every ladderway floor opening or platform with access provided by ladderway, including ship stairs (ship ladders), shall be protected by guardrails with toeboards meeting the requirements of General Industry Safety Orders, Section 3209, on all exposed sides except at entrance to the opening. The opening through the railing shall have either a swinging gate or equivalent protection, or the passageway to the opening shall be so offset that a person cannot walk directly into the opening.	Ladder was move to a new anchor point.
	7A	8/15/2014	9/8/2014	Cupertino, CA	Lehigh Southwest Cement Company	3212(A)(2)(A)	(2)(A) Every ladderway floor opening or platform with access provided by ladderway, including ship stairs (ship ladders), shall be protected by guardrails with toeboards meeting the requirements of General Industry Safety Orders, Section 3209, on all exposed sides except at entrance to the opening. The opening through the railing shall have either a swinging gate or equivalent protection, or the passageway to the opening shall be so offset that a person cannot walk directly into the opening.	Floor opening was guarded adequately
7	7B	8/15/2014	8/20/2014	Cupertino, CA	Lehigh Southwest Cement Company	5048(J)	(j) Synthetic Web Sling Storage. Synthetic web slings shall be stored in an area or facility where they are not subject to heat above 150o F or exposed to direct sunlight.	Synthetic web slings were stored properly
	7C	8/15/2014	8/20/2014	Cupertino, CA	Lehigh Southwest Cement Company	5162(A)	(a) Plumbed or self-contained eyewash or eye/facewash equipment which meets the requirements of sections 5, 7, or 9 of ANSI Z358.1-1981, Emergency Eyewash and Shower Equipment, incorporated herein by this reference, shall be provided at all work areas where, during routine operations or foreseeable emergencies, the eyes of an employee may come into contact with a substance which can cause corrosion, severe irritation or permanent tissue damage or which is toxic by absorption. Water hoses, sink faucets, or showers are not acceptable eyewash facilities. Personal eyewash units or drench hoses which meet the requirements of section 6 or 8 of ANSI Z358.1-1981, hereby incorporated by reference, may support plumbed or self-contained units but shall not be used in lieu of them.	Eye Wash station was provided.
8	8A	4/18/2014	5/5/2014	Cupertino, CA	Lehigh Southwest Cement Company	2340.1	Electrical equipment shall be maintained free from recognized hazards that are likely to cause death or serious physical harm to employees.	Electrical equipment was properly maintained.
	8B	4/18/2014	4/23/2014	Cupertino, CA	Lehigh Southwest Cement Company	4851(E.)(4)	(4) Insulated connectors of equivalent capacity shall be used for connecting or splicing cable. Cable lugs, where used as connectors, shall provide electrical contact. Exposed metal parts shall be insulated.	Proper insulated connectors were provided.



Search County Government

Home | County Commission | Doing Business | Visiting

ENVIROS

Enforcement Action Advanced Search

Search Again

Type	Enforcement #	Address	Section Township Range	Facility Status	Violation Date Time	Issue Date	Completed Date
▶ Notice of Violation	NOV07-0068	2802 EISENHOWER BLVD Fort Lauderdale, FL 33316	23-50-42	07059 Closed	Oct 02, 2007 10:00	Nov 20, 2007	Jul 25, 2008
▶ Warning Notice	WRN06-0120	19681 SW 69TH PL Pembroke Pines, FL 33332	02-51-39	02770 Complied	Feb 10, 2006 9:00	Feb 21, 2006	Aug 9, 2006
▶ Warning Notice	WRN07-0441	2802 EISENHOWER BLVD Fort Lauderdale, FL 33316	23-50-42	07059 Complied	Jun 26, 2007 11:30	Jul 24, 2007	Aug 14, 2007
▶ Warning Notice	WRN07-0680	2802 EISENHOWER BLVD Fort Lauderdale, FL 33316	23-50-42	07059 Complied	Sep 21, 2007 9:00	Sep 25, 2007	Oct 30, 2007

[Help on this page](#)

Screen ID: 23473



- Contact Us
- Comments and Suggestions
- Report a Complaint
- Site Map

- Broward.org
- Terms of Use
- Subscribe

Stay Connected





Search County Government

Home | County Commission | Doing Business | Visiting

ENVIROS

Enforcement Action Advanced Search

⊗ No information was found matching your selection criteria. Please try again.

Enforcement Action Number:

House Number: To:

Street:
Direction Street Name Street Type Suite

City: Zip:

Section: Township: Range:

Respondent:

[Help on this page](#)

Screen ID: 23473



- Contact Us
- Comments and Suggestions
- Report a Complaint
- Site Map

- Broward.org
- Terms of Use
- Subscribe

Stay Connected





Florida Department of Environmental Protection

Hazardous Waste Facilities Search Results

Selection Criteria for This Handler Search:

EPAID: % ; Name: CONTINENTAL FLORIDA MATERIALS% ; Address: % ; City: % ; County: %

For Facility Data Links:

Activities -- provides a list of RCRA compliance activities and violations.

For a Generator Status History:

click on the **Status**. - **NOT** indicates a facility is a Non-Notifier and may not have been issued the associated EPAID - **Check with DEP before using that EPAID!**

Mapping in GIS -- this opens a **[NEW IMPROVED]** GIS mapping tool focused on the facility.

[Legend of Status Types](#)

Documents -- this provides a list of electronic documents available online.

Error Reporting -- send us feedback to address data errors.

County Verification -- County or RPC verification of Facility and Waste for this site.

EPA ID	Name	County	Address	Contact	Status As of	Data Links
FLD984181420	Continental Florida Materials Inc	Palm Beach	1860 NW 1st St Delray Beach, FL 33444	Tom Moody 4072782807	CLO 3/20/2013	A M D E

Search has retrieved 1 Facilities

Legend of Status Types:

- LQG - Large Quantity Generator
- SQG - Small Quantity Generator
- CES - Conditionally Exempt Small Quantity Generator
- UOT - Used Oil Transporter
- TRA - Hazardous Waste Transporter
- TSD - Treatment/Storage/Disposal Facility
- CLO - Closed
- NHR - Non-Handler of Hazardous Waste



Florida Department of Environmental Protection

Hazardous Waste Facility Compliance History

Activity History Listing

Activity History for:

EPAID: FLD984181420, Continental Florida Materials Inc

Note: ETA links to Enforcement Tracking Activity

Date Done	Activity Type	Activity Comments	ETA Link
12/20/2012	Site Inspection	Routine; Closed	

This pulls the Violation History

Violation History

No Violations Found for this EPAID

Vio#	Area Regulation	Opened Date	Completed Date	ETA Act	Act	Regulation Text Excerpt (mouse over for more text)



OSHA English | Spanish

Find it in OSHA



A TO Z INDEX

ABOUT OSHA ▾ **WORKERS** ▾ **EMPLOYERS** ▾ **REGULATIONS** ▾ **ENFORCEMENT** ▾ **TOPICS** ▾ **NEWS & PUBLICATIONS** ▾ **DATA** ▾ **TRAINING** ▾

Alert: Due to technical difficulties with the website, some pages are temporarily unavailable.
Please stop back later.

If you need to file a complaint with OSHA or to ask a safety or health question, please contact us at 1-800-321-6742 (OSHA).

UNITED STATES
DEPARTMENT OF LABOR

Occupational Safety and Health Administration
200 Constitution Ave., NW,
Washington, DC 20210
☎ 800-321-6742 (OSHA)
TTY
www.OSHA.gov

FEDERAL GOVERNMENT

White House
Affordable Care Act
Disaster Recovery Assistance
USA.gov
Plain Writing Act
Recovery Act
No Fear Act
U.S. Office of Special Counsel

OCCUPATIONAL SAFETY AND HEALTH

Frequently Asked Questions
A - Z Index
Freedom of Information Act
Read the OSHA Newsletter
Subscribe to the OSHA Newsletter
OSHA Publications
Office of Inspector General

ABOUT THE SITE

Freedom of Information Act
Privacy & Security Statement
Disclaimers
Important Web Site Notices
Plug-ins Used by DOL
RSS Feeds from DOL
Accessibility Statement



OSHA English | Spanish

Find it in OSHA

A TO Z INDEX

OSHA ▾ **WORKER** ▾ **EMPLOYER** ▾ **STANDARDS** ▾ **ENFORCEMENT** ▾ **CONSTRUCTION TOPIC** ▾ **NEWS/RESOURCES** ▾ **DATA** ▾ **TRAINING** ▾

Establishment Search

Reflects inspection data through 02/20/2019

This page enables the user to search for OSHA enforcement inspections by the name of the establishment. Information may also be obtained for a specified inspection or inspections within a specified SIC.

Note: Please read important information below regarding interpreting search results before using.

Search By:

Your search did not return any results.

Establishment

(This box can also be used to search for a State Activity Number for the following states: NC, SC, KY, IN, OR and WA)

State ▾ ▾

OSHA Office ▾

Site Zip Code

Case Status All Closed Open

Violation Status All With Violations Without Violations

Inspection Date

Start Date ▾ ▾ ▾

End Date ▾ ▾ ▾

Can't find it?

- [Wildcard use %](#)
- [Basic Establishment Search Instructions](#)
- [Advanced Search Syntax](#)

NOTE TO USERS

The Integrated Management Information System (IMIS) was designed as an information resource for in-house use by OSHA staff and management, and by state agencies which carry out federally-approved OSHA programs. Access to this OSHA work product is being afforded via the Internet for the use of members of the public who wish to track OSHA interventions at particular work sites or to perform statistical analyses of OSHA enforcement activity. It is critical that users of the data understand several aspects of the system in order to accurately use the information.

The source of the information in the IMIS is the local federal or state office in the geographical area where the activity occurred. Information is entered as events occur in the course of agency activities. Until cases are closed, IMIS entries concerning specific OSHA inspections are subject to correction and updating, particularly with regard to citation items, which are subject to modification by amended citations, settlement agreements, or as a result of contest proceedings. THE USER SHOULD ALSO BE AWARE THAT DIFFERENT COMPANIES MAY HAVE SIMILAR NAMES AND CLOSE ATTENTION TO THE ADDRESS MAY BE NECESSARY TO AVOID MISINTERPRETATION.

The Integrated Management Information System (IMIS) is designed and administered as a management tool for OSHA to help it direct its resources. When IMIS is put to new or different uses, the data should be verified by reference to the case file and confirmed by the appropriate federal or state office. Employers or employees who believe a particular IMIS entry to be inaccurate, incomplete or out-of-date are encouraged to contact the OSHA field office or state plan agency which originated the entry.

UNITED STATES
DEPARTMENT OF LABOR

Occupational Safety and Health Administration
200 Constitution Ave NW
Washington, DC 20210
☎ 800-321-6742 (OSHA)
TTY
www.OSHA.gov

FEDERAL GOVERNMENT

White House
Disaster Recovery Assistance
USA.gov
No Fear Act Data
U.S. Office of Special Counsel

OCCUPATIONAL SAFETY AND HEALTH

Frequently Asked Questions
A - Z Index
Freedom of Information Act
Read the OSHA Newsletter
Subscribe to the OSHA Newsletter
OSHA Publications
Office of Inspector General

ABOUT THE SITE

Freedom of Information Act
Privacy & Security Statement
Disclaimers
Important Website Notices
Plug-Ins Used by DOL
Accessibility Statement



OSHA English | Spanish

Find it in OSHA



A TO Z INDEX

OSHA ▾ **WORKER** ▾ **EMPLOYER** ▾ **STANDARDS** ▾ **ENFORCEMENT** ▾ **CONSTRUCTION TOPIC** ▾ **NEWS/RESOURCES** ▾ **DATA** ▾ **TRAINING** ▾

Inspection Detail

Case Status: PENDING ABATEMENT OF VIOLATIONS

Note: The following inspection has not been indicated as closed. Please be aware that the information shown may change, e.g. violations may be added or deleted. For open cases, in which a citation has been issued, the citation information may not be available for 5 days following receipt by the employer for Federal inspections or for 30 days following receipt by the employer for State inspections.

Inspection: 1285640.015 - Lehigh Southwest Cement Company

Inspection Information - Office: Ca Sacramento M&T District Office

Nr: 1285640.015 Report ID: 0950651 Open Date: 12/31/2017

Lehigh Southwest Cement Company
24001 Stevens Creek Blvd
Cupertino, CA 95014 Union Status: NonUnion

SIC:
NAICS: 212312/Crushed and Broken Limestone Mining and Quarrying
Mailing: 24001 Stevens Creek Blvd, Cupertino, CA 95014

Inspection Type: Fat/Cat
Scope: Complete Advanced Notice: N
Ownership: Private
Safety/Health: Safety Close Conference: 05/16/2018
Emphasis: S:Mining Close Case:
Related Activity: Type ID Safety Health
Accident 1296844

Case Status: PENDING ABATEMENT OF VIOLATIONS

Violation Summary

	Serious	Willful	Repeat	Other	Unclass	Total
Initial Violations	4					4
Current Violations	4					4
Initial Penalty	\$93,000	\$0	\$0	\$0	\$0	\$93,000
Current Penalty	\$93,000	\$0	\$0	\$0	\$0	\$93,000
FTA Amount	\$0	\$0	\$0	\$0	\$0	\$0

Violation Items

#	ID	Type	Standard	Issuance	Abate	Curr\$	Init\$	Fta\$	Contest	LastEvent
1.	01001	Serious	3203(A)(6)	05/18/2018	06/06/2018	\$25,000	\$25,000	\$0	07/05/2018	-
2.	02001	Serious	6973(G)	05/18/2018	06/06/2018	\$25,000	\$25,000	\$0	07/05/2018	-
3.	03001	Serious	7010(H)	05/18/2018	06/06/2018	\$18,000	\$18,000	\$0	07/05/2018	-
4.	04001	Serious	7012(H)	05/18/2018	06/06/2018	\$25,000	\$25,000	\$0	07/05/2018	-

Accident Investigation Summary

Summary Nr: 101848.015

Event: 12/30/2017

Employee IS Trapped In Burning Truck Cab And IS Killed

EXHIBIT 3

Page 271 of 289

At 9:30 a.m. on December 30, 2017, an employee had driven to a worksite to pick up a coworker and parked directly behind the Caterpillar 992 Wheel Loader. The coworker reversed the Loader and struck the pick-up truck that the employee had driven and trapped the employee within the cab. The cab caught on fire with the employee still trapped within. The coworker quickly pulled forward immediately after the impact and several coworkers attempted to extinguish the fire and pull the employee from the cab. The Santa Clara County Fire Engine #77 arrived on scene and pronounced the employee as deceased at the scene at approximately 9:41 a.m.

Keywords: pickup truck, struck by, burn, fire

	Inspection			Degree	Nature	Occupation
1	1285640.015			Fatality	Burn/Scald(Heat)	Laborers, except construction

UNITED STATES
DEPARTMENT OF LABOR

Occupational Safety and Health Administration
200 Constitution Ave NW
Washington, DC 20210
☎ 800-321-6742 (OSHA)
TTY
www.OSHA.gov

FEDERAL GOVERNMENT

White House
Disaster Recovery Assistance
USA.gov
No Fear Act Data
U.S. Office of Special Counsel

OCCUPATIONAL SAFETY AND HEALTH

Frequently Asked Questions
A - Z Index
Freedom of Information Act
Read the OSHA Newsletter
Subscribe to the OSHA Newsletter
OSHA Publications
Office of Inspector General

ABOUT THE SITE

Freedom of Information Act
Privacy & Security Statement
Disclaimers
Important Website Notices
Plug-Ins Used by DOL
Accessibility Statement



OSHA English | Spanish

Find it in OSHA



A TO Z INDEX

OSHA ▾ WORKER ▾ EMPLOYER ▾ STANDARDS ▾ ENFORCEMENT ▾ CONSTRUCTION TOPIC ▾ NEWS/RESOURCES ▾ DATA ▾ TRAINING ▾

Inspection Detail

Case Status: **CLOSED**

Inspection: **1240576.015 - Lehigh Southwest Cement Company**

Inspection Information - Office: Ca Van Nuys-Min/Tunn

Nr: 1240576.015 Report ID: 0950652 Open Date: 06/15/2017
 Lehigh Southwest Cement Company
 13573 Tehachapi Blvd.
 Tehachapi, CA 93561 Union Status: NonUnion
 SIC:
 NAICS: 212312/Crushed and Broken Limestone Mining and Quarrying
 Mailing: 13573 Tehachapi Blvd., Tehachapi, CA 93561
 Inspection Type: Planned
 Scope: Complete Advanced Notice: N
 Ownership: Private
 Safety/Health: Safety Close Conference: 07/20/2017
 Emphasis: S:Mining, P:Mining Close Case: 07/18/2018

Case Status: **CLOSED**

Violation Summary

	Serious	Willful	Repeat	Other	Unclass	Total
Initial Violations				2		2
Current Violations				2		2
Initial Penalty	\$0	\$0	\$0	\$525	\$0	\$525
Current Penalty	\$0	\$0	\$0	\$470	\$0	\$470
FTA Amount	\$0	\$0	\$0	\$0	\$0	\$0

Violation Items

#	ID	Type	Standard	Issuance	Abate	Curr\$	Init\$	Fta\$	Contest	LastEvent
1.	01001	Other	3328(G)	07/21/2017	08/16/2017	\$210	\$210	\$0	08/04/2017	Z - Issued
2.	01002	Other	4002(A)	07/21/2017	08/16/2017	\$260	\$315	\$0	08/04/2017	F - Formal Settlement

UNITED STATES
DEPARTMENT OF LABOR

Occupational Safety and Health Administration
200 Constitution Ave NW
Washington, DC 20210

FEDERAL GOVERNMENT

[White House](#)
[Disaster Recovery Assistance](#)
[USA.gov](#)
[No Fear Act Data](#)
[U.S. Office of Special Counsel](#)

OCCUPATIONAL SAFETY AND HEALTH

[Frequently Asked Questions](#)
[A - Z Index](#)
[Freedom of Information Act](#)
[Read the OSHA Newsletter](#)
[Subscribe to the OSHA Newsletter](#)
[OSHA Publications](#)
[Office of Inspector General](#)

ABOUT THE SITE

[Freedom of Information Act](#)
[Privacy & Security Statement](#)
[Disclaimers](#)
[Important Website Notices](#)
[Plug-Ins Used by DOL](#)
[Accessibility Statement](#)



OSHA English | Spanish

Find it in OSHA



A TO Z INDEX

OSHA ▾ WORKER ▾ EMPLOYER ▾ STANDARDS ▾ ENFORCEMENT ▾ CONSTRUCTION TOPIC ▾ NEWS/RESOURCES ▾ DATA ▾ TRAINING ▾

Inspection Detail

Case Status: **CLOSED**

Inspection: **1206552.015 - Lehigh Southwest Cement Company**

Inspection Information - Office: Ca Sacramento M&T District Office

Nr: 1206552.015	Report ID: 0950651	Open Date: 01/24/2017
Lehigh Southwest Cement Company 24001 Stevens Creek Blvd Cupertino, CA 95014		Union Status: Union
SIC: NAICS: 212312/Crushed and Broken Limestone Mining and Quarrying Mailing: 24001 Stevens Creek Blvd, Cupertino, CA 95014		
Inspection Type: Complaint	Scope: Partial	Advanced Notice: N
Ownership: Private	Safety/Health: Safety	Close Conference: 06/27/2017
Emphasis: S:Mining		Close Case: 05/09/2018
Related Activity: Type	ID	Safety
Complaint	1178108	Health Yes
Complaint	1178108	Yes

Case Status: **CLOSED**

Violation Summary

	Serious	Willful	Repeat	Other	Unclass	Total
Initial Violations				4		4
Current Violations				4		4
Initial Penalty	\$0	\$0	\$0	\$1,130	\$0	\$1,130
Current Penalty	\$0	\$0	\$0	\$1,130	\$0	\$1,130
FTA Amount	\$0	\$0	\$0	\$0	\$0	\$0

Violation Items

#	ID	Type	Standard	Issuance	Abate	Curr\$	Init\$	Fta\$	Contest	LastEvent
1.	01001	Other	3273(I)	07/12/2017	07/24/2017	\$260	\$260	\$0		Z - Issued
2.	01002	Other	3277(G)(4)	07/12/2017	07/24/2017	\$350	\$350	\$0		Z - Issued
3.	01003	Other	3340(C)	07/12/2017	07/24/2017	\$260	\$260	\$0		Z - Issued
4.	01004	Other	3340(E)	07/12/2017	07/24/2017	\$260	\$260	\$0		Z - Issued

Occupational Safety and Health Administration
200 Constitution Ave NW
Washington, DC 20210
☎ 800-321-6742 (OSHA)
TTY
www.OSHA.gov

FEDERAL GOVERNMENT

[White House](#)
[Disaster Recovery Assistance](#)
[USA.gov](#)
[No Fear Act Data](#)
[U.S. Office of Special Counsel](#)

OCCUPATIONAL SAFETY AND HEALTH

[Frequently Asked Questions](#)
[A - Z Index](#)
[Freedom of Information Act](#)
[Read the OSHA Newsletter](#)
[Subscribe to the OSHA Newsletter](#)
[OSHA Publications](#)
[Office of Inspector General](#)

ABOUT THE SITE

[Freedom of Information Act](#)
[Privacy & Security Statement](#)
[Disclaimers](#)
[Important Website Notices](#)
[Plug-Ins Used by DOL](#)
[Accessibility Statement](#)



OSHA English | Spanish

Find it in OSHA



A TO Z INDEX

OSHA ▾ **WORKER** ▾ **EMPLOYER** ▾ **STANDARDS** ▾ **ENFORCEMENT** ▾ **CONSTRUCTION TOPIC** ▾ **NEWS/RESOURCES** ▾ **DATA** ▾ **TRAINING** ▾

Inspection Detail

Case Status: CLOSED

Inspection: 1064557.015 - Lehigh Northeast Cement Company

Inspection Information - Office: North Boston

Nr: 1064557.015	Report ID: 0134000	Open Date: 05/20/2015
Lehigh Northeast Cement Company		
90 Eames Street		
Wilmington, MA 01887		Union Status: NonUnion
SIC:		
NAICS: 327310/Cement Manufacturing		
Mailing: 90 Eames Street , Wilmington, MA 01887		
Inspection Type:	Referral	
Scope:	Partial	Advanced Notice: N
Ownership:	Private	
Safety/Health:	Safety	Close Conference: 05/20/2015
		Close Case: 09/28/2015
Related Activity:	Type	ID
	Referral	984599
		Safety
		Yes
		Health

Case Status: CLOSED

Violation Summary

	Serious	Willful	Repeat	Other	Unclass	Total
Initial Violations	2					2
Current Violations	2					2
Initial Penalty	\$9,000	\$0	\$0	\$0	\$0	\$9,000
Current Penalty	\$4,500	\$0	\$0	\$0	\$0	\$4,500
FTA Amount	\$0	\$0	\$0	\$0	\$0	\$0

Violation Items

#	ID	Type	Standard	Issuance	Abate	Curr\$	Init\$	Fta\$	Contest	LastEvent
1.	01001	Serious	19100147 C04 I	07/06/2015	08/08/2015	\$2,500	\$5,000	\$0		I - Informal Settlement
2.	01002	Serious	19100151 C	07/06/2015	08/08/2015	\$2,000	\$4,000	\$0		I - Informal Settlement

UNITED STATES
DEPARTMENT OF LABOR

FEDERAL GOVERNMENT

[White House](#)
[Disaster Recovery Assistance](#)
[USA.gov](#)
[No Fear Act Data](#)
[U.S. Office of Special Counsel](#)

OCCUPATIONAL SAFETY AND HEALTH

[Frequently Asked Questions](#)
[A - Z Index](#)
[Freedom of Information Act](#)
[Read the OSHA Newsletter](#)
[Subscribe to the OSHA Newsletter](#)
[OSHA Publications](#)
[Office of Inspector General](#)

ABOUT THE SITE

[Freedom of Information Act](#)
[Privacy & Security Statement](#)
[Disclaimers](#)
[Important Website Notices](#)
[Plug-Ins Used by DOL](#)
[Accessibility Statement](#)



OSHA English | Spanish

Find it in OSHA



A TO Z INDEX

OSHA ▾ **WORKER** ▾ **EMPLOYER** ▾ **STANDARDS** ▾ **ENFORCEMENT** ▾ **CONSTRUCTION TOPIC** ▾ **NEWS/RESOURCES** ▾ **DATA** ▾ **TRAINING** ▾

Inspection Detail

Case Status: CLOSED

Inspection: 1011879.015 - Lehigh Southwest Cement Company

Inspection Information - Office: Ca Sacramento M&T District Office

Nr: 1011879.015	Report ID: 0950651	Open Date: 12/02/2014
Lehigh Southwest Cement Company 15390 Wonderland Blvd Redding, CA 96003		Union Status: Union
SIC: NAICS: 212312/Crushed and Broken Limestone Mining and Quarrying Mailing: 15390 Wonderland Blvd, Redding, CA 96003		
Inspection Type: Planned		
Scope: Complete	Advanced Notice: N	
Ownership: Private		
Safety/Health: Safety	Close Conference: 12/04/2014	
Emphasis: P:Tunnel, S:Tunnel	Close Case: 02/08/2016	

Case Status: CLOSED

Violation Summary

	Serious	Willful	Repeat	Other	Unclass	Total
Initial Violations				2		2
Current Violations				2		2
Initial Penalty	\$0	\$0	\$0	\$225	\$0	\$225
Current Penalty	\$0	\$0	\$0	\$225	\$0	\$225
FTA Amount	\$0	\$0	\$0	\$0	\$0	\$0

Violation Items

#	ID	Type	Standard	Issuance	Abate	Curr\$	Init\$	Fta\$	Contest	LastEvent
1.	01001	Other	4002(A)	01/09/2015	01/28/2015	\$225	\$225	\$0		Z - Issued
2.	02001	Other	3212(A)(2)(A)	01/09/2015	01/28/2015	\$0	\$0	\$0		Z - Issued

UNITED STATES
DEPARTMENT OF LABOR

Occupational Safety and Health Administration
200 Constitution Ave NW
Washington, DC 20210

FEDERAL GOVERNMENT

[White House](#)
[Disaster Recovery Assistance](#)
[USA.gov](#)
[No Fear Act Data](#)
[U.S. Office of Special Counsel](#)

OCCUPATIONAL SAFETY AND HEALTH

[Frequently Asked Questions](#)
[A - Z Index](#)
[Freedom of Information Act](#)
[Read the OSHA Newsletter](#)
[Subscribe to the OSHA Newsletter](#)
[OSHA Publications](#)
[Office of Inspector General](#)

ABOUT THE SITE

[Freedom of Information Act](#)
[Privacy & Security Statement](#)
[Disclaimers](#)
[Important Website Notices](#)
[Plug-Ins Used by DOL](#)
[Accessibility Statement](#)



OSHA English | Spanish

Find it in OSHA



A TO Z INDEX

OSHA ▾ **WORKER** ▾ **EMPLOYER** ▾ **STANDARDS** ▾ **ENFORCEMENT** ▾ **CONSTRUCTION TOPIC** ▾ **NEWS/RESOURCES** ▾ **DATA** ▾ **TRAINING** ▾

Inspection Detail

Case Status: CLOSED

Inspection: 1044113.015 - Lehigh Southwest Cement Company

Inspection Information - Office: Ca Sacramento M&T District Office

Nr: 1044113.015 Report ID: 0950651 Open Date: 03/05/2015

Lehigh Southwest Cement Company
24001 Stevens Creek Blvd
Cupertino, CA 95014 Union Status: Union

SIC:
NAICS: 212312/Crushed and Broken Limestone Mining and Quarrying
Mailing: 24001 Stevens Creek Blvd, Cupertino, CA 95014

Inspection Type: Accident
Scope: Partial Advanced Notice: N
Ownership: Private
Safety/Health: Safety Close Conference: 09/01/2015
Emphasis: S:Tunnel Close Case: 03/21/2016

Related Activity: Type ID Safety Health
Accident 966678

Case Status: CLOSED

Violation Summary

	Serious	Willful	Repeat	Other	Unclass	Total
Initial Violations	2			1		3
Current Violations	1			1		2
Initial Penalty	\$36,000	\$0	\$0	\$5,000	\$0	\$41,000
Current Penalty	\$18,000	\$0	\$0	\$5,000	\$0	\$23,000
FTA Amount	\$0	\$0	\$0	\$0	\$0	\$0

Violation Items

	#	ID	Type	Standard	Issuance	Abate	Curr\$	Init\$	Fta\$	Contest	LastEvent
	1.	01001	Other	342(A)	09/02/2015		\$5,000	\$5,000	\$0	09/14/2015	F - Formal Settlement
	2.	02001	Serious	3203(A)(4)(C)	09/02/2015		\$18,000	\$18,000	\$0	09/14/2015	F - Formal Settlement
Deleted	3.	03001	Serious	3203(A)(6)(A)	09/02/2015		\$0	\$18,000	\$0	09/14/2015	F - Formal Settlement

FEDERAL GOVERNMENT

[White House](#)

[Disaster Recovery Assistance](#)

[USA.gov](#)

[No Fear Act Data](#)

[U.S. Office of Special Counsel](#)

OCCUPATIONAL SAFETY AND HEALTH

[Frequently Asked Questions](#)

[A - Z Index](#)

[Freedom of Information Act](#)

[Read the OSHA Newsletter](#)

[Subscribe to the OSHA Newsletter](#)

[OSHA Publications](#)

[Office of Inspector General](#)

ABOUT THE SITE

[Freedom of Information Act](#)

[Privacy & Security Statement](#)

[Disclaimers](#)

[Important Website Notices](#)

[Plug-Ins Used by DOL](#)

[Accessibility Statement](#)



OSHA English | Spanish

Find it in OSHA



A TO Z INDEX

OSHA ▾ **WORKER** ▾ **EMPLOYER** ▾ **STANDARDS** ▾ **ENFORCEMENT** ▾ **CONSTRUCTION TOPIC** ▾ **NEWS/RESOURCES** ▾ **DATA** ▾ **TRAINING** ▾

Inspection Detail

Inspection: 317133957 - Lehigh Southwest Cement Company

Inspection Information - Office: Ca Sacramento M&T District Office

Nr: 317133957	Report ID: 0950651	Open Date: 04/01/2014
Lehigh Southwest Cement Company		
24001 Stevens Creek Blvd		
Cupertino, CA 95014	Union Status: Union	
SIC: 1422/Crushed and Broken Limestone		
NAICS: 212312/Crushed and Broken Limestone Mining and Quarrying		
Inspection Type:	Planned	
Scope:	Complete	Advanced Notice: N
Ownership:	Private	
Safety/Health:	Safety	Close Conference: 04/07/2014
Emphasis:	L:Tunnel	Close Case: 08/28/2014

Violation Summary

	Serious	Willful	Repeat	Other	Unclass	Total
Initial Violations				2		2
Current Violations				2		2
Initial Penalty	\$0	\$0	\$0	\$450	\$0	\$450
Current Penalty	\$0	\$0	\$0	\$450	\$0	\$450
FTA Amount	\$0	\$0	\$0	\$0	\$0	\$0

Violation Items

#	ID	Type	Standard	Issuance	Abate	Curr\$	Init\$	Fta\$	Contest	LastEvent
1.	01001	Other	23400001	04/18/2014	05/05/2014	\$300	\$300	\$0		-
2.	01002	Other	4851 E04	04/18/2014	04/23/2014	\$150	\$150	\$0		-

UNITED STATES
DEPARTMENT OF LABOR

Occupational Safety and Health Administration
200 Constitution Ave NW
Washington, DC 20210
☎ 800-321-6742 (OSHA)
TTY
www.OSHA.gov

FEDERAL GOVERNMENT

[White House](#)
[Disaster Recovery Assistance](#)
[USA.gov](#)
[No Fear Act Data](#)
[U.S. Office of Special Counsel](#)

OCCUPATIONAL SAFETY AND HEALTH

[Frequently Asked Questions](#)
[A - Z Index](#)
[Freedom of Information Act](#)
[Read the OSHA Newsletter](#)
[Subscribe to the OSHA Newsletter](#)
[OSHA Publications](#)
[Office of Inspector General](#)

ABOUT THE SITE

[Freedom of Information Act](#)
[Privacy & Security Statement](#)
[Disclaimers](#)
[Important Website Notices](#)
[Plug-Ins Used by DOL](#)
[Accessibility Statement](#)

EXHIBIT 3

Page 283 of 289



OSHA English | Spanish

Find it in OSHA



A TO Z INDEX

OSHA ▾ **WORKER** ▾ **EMPLOYER** ▾ **STANDARDS** ▾ **ENFORCEMENT** ▾ **CONSTRUCTION TOPIC** ▾ **NEWS/RESOURCES** ▾ **DATA** ▾ **TRAINING** ▾

Inspection Detail

Inspection: 317135200 - Lehigh Southwest Cement Company

Inspection Information - Office: Ca Sacramento M&T District Office

Nr: 317135200	Report ID: 0950651	Open Date: 07/31/2014
Lehigh Southwest Cement Company		
24001 Stevens Creek Blvd		
Cupertino, CA 95014	Union Status: Union	
SIC: 1499/Miscellaneous Nonmetallic Minerals, Except Fuels		
NAICS: 212399/All Other Nonmetallic Mineral Mining		
Mailing: 24001 Stevens Creek Blvd, Cupertino, CA 95014		
Inspection Type:	Planned	
Scope:	Complete	Advanced Notice: N
Ownership:	Private	
Safety/Health:	Safety	Close Conference: 08/05/2014
Emphasis:	L:Tunnel	Close Case: 11/14/2018

Violation Summary

	Serious	Willful	Repeat	Other	Unclass	Total
Initial Violations				3		3
Current Violations				3		3
Initial Penalty	\$0	\$0	\$0	\$1,125	\$0	\$1,125
Current Penalty	\$0	\$0	\$0	\$1,125	\$0	\$1,125
FTA Amount	\$0	\$0	\$0	\$0	\$0	\$0

Violation Items

#	ID	Type	Standard	Issuance	Abate	Curr\$	Init\$	Fta\$	Contest	LastEvent
1.	01001	Other	3212 A02 A	08/15/2014	09/08/2014	\$675	\$675	\$0	09/03/2014	F - Formal Settlement
2.	01002	Other	5048 J	08/15/2014	08/20/2014	\$450	\$450	\$0		-
3.	02001	Other	5162 A	08/15/2014	08/20/2014	\$0	\$0	\$0		-

UNITED STATES
DEPARTMENT OF LABOR

Occupational Safety and Health Administration
200 Constitution Ave NW
Washington, DC 20210

FEDERAL GOVERNMENT

[White House](#)
[Disaster Recovery Assistance](#)
[USA.gov](#)
[No Fear Act Data](#)
[U.S. Office of Special Counsel](#)

OCCUPATIONAL SAFETY AND HEALTH

[Frequently Asked Questions](#)
[A - Z Index](#)
[Freedom of Information Act](#)
[Read the OSHA Newsletter](#)
[Subscribe to the OSHA Newsletter](#)
[OSHA Publications](#)
[Office of Inspector General](#)

ABOUT THE SITE

[Freedom of Information Act](#)
[Privacy & Security Statement](#)
[Disclaimers](#)
[Important Website Notices](#)
[Plug-Ins Used by DOL](#)
[Accessibility Statement](#)

From: efoia@uscg.mil
To: [Osorno-Belleme, Angela](#)
Subject: RE: Your Freedom of Information Act (FOIA)/Privacy Act (PA) 2019-CGFO-00756
Date: Tuesday, January 22, 2019 1:16:21 PM
Attachments: [Non-DoD Source Freedom of Information Act Request1.msg](#)

Ms. Osorno-Belleme,

This acknowledges receipt of your January 22, 2019, Freedom of Information Act (FOIA) request to the U.S. Coast Guard (USCG). Your request was received on January 22, 2019 and has been assigned FOIA[PA] number 2019-CGFO-00756.

We have queried the appropriate component of the USCG for responsive records. If any responsive records are located, they will be reviewed for determination of releasability. Please be assured that one of the processors in our office will respond to your request as expeditiously as possible. We appreciate your patience as we proceed with your request.

Please note that due to a lapse in federal funding a delay in processing will occur.

You may check the status of your request by entering FOIA[PA] request number 2019-CGFO-00756 into the following site: <http://www.dhs.gov/foia-status>. Request status is updated and refreshed on a nightly basis electronically.

You may contact this office via telephone at 202-475-3522 or via email at EFOIA@uscg.mil if you have any further questions.

Sincerely,

U.S. Coast Guard
FOIA/PA Office



Commandant
United States Coast Guard

BUSINESS ADMINISTRATION

2019 MAR 18 PM 4:39

2703 Martin Luther King Jr., Ave., SE
Stop 7501
Washington, DC 20593-7501
Staff Symbol: CG-INV-3
Phone: (202) 372-1283
Fax: (202) 372-8366
Email: Ternia.r.Pipkins@uscg.mil

5720
FOIA 2019-CGFO-00756
February 27, 2019

Ms. Angela Osorno Belleme
Port Everglades Department
1850 Eller Dr., Suite 603
Ft. Lauderdale, FL 33316-4201

Dear Ms. Osorno Belleme:

This letter is in response to your Freedom of Information Act (FOIA) request of January 22, 2019, for any environmental infractions, fines, penalties, and resolutions associated with Continental Florida Materials, Inc. Seaport Hub Agencies, Inc., Homeland Patrol Corporation from January 1, 2014 to present. This office received your request on January 22, 2019.

A search of the Marine Information for Safety and Law Enforcement (MISLE) database found no records responsive to your request. The search looked for any environmental infractions, fines, penalties, and resolutions associated with Continental Florida Materials, Inc. Seaport Hub Agencies, Inc., Homeland Patrol Corporation from January 1, 2014 to present. The search was conducted on keywords: Continental Florida Materials, Inc. Seaport Hub Agencies, Inc., Homeland Patrol Corporation from January 1, 2014 to present. This records search was conducted February 27, 2019 by Ms. Ternia Pipkins, IT Specialist, of Commandant (CG-INV-3). We conducted a reasonable search for records responsive to your request and conclude there are no responsive records.

This is not a denial. You may appeal the adequacy of our search. Your appeal must be made in writing and you must submit it within 60 days from the date of receipt of this letter. Your letter should indicate that you are making an appeal based on a "no records" determination of a request made under the Freedom of Information Act and the envelope should be prominently marked "FOIA Appeal." Include in your appeal the reason(s) why you believe the search was inadequate and a copy of this letter. Send your appeal to:

Commandant (CG-611)
U.S. Coast Guard
Attn: FOIA/PA Officer
2703 Martin Luther King Jr. Ave., SE, STOP 7710
Washington, DC 20593-7710

If you have any questions concerning this matter, please contact this office at 202-372-1283 and refer to FOIA NUMBER 2019- CGFO-00756.

Sincerely,

A handwritten signature in blue ink that reads "D. Patterson".

D. PATTERSON
Chief, Data Administration Division
U.S. Coast Guard
By direction

Section R

Continental Florida Materials has been operating in Florida seaports along the east coast for thirty-eight (38) years.

The core business activity of Continental Florida Materials is the commercialization in the Florida market of Portland and slag cements, primarily in bulk form. The company is a self provider of the required stevedore activities to move the material into their storage silos. The named cementitious materials are procured from parent companies with global marketplace footprint, given the company the advantage of being part of a logistics network better protected from overall market conditions.

The performance of the company strongly correlates with the construction industry in the state of Florida as a whole. Through several business cycles, including the economic downturn at the beginning of the century, the company has been able to maintain sustainable operations.

Just in the last five years, we have shipped close to 2.2 Million tons of product from the terminal, with volumes increasing by almost 70% between the first (2014) and last years (2018) of that time span.

The PCA (Portland Cement Association) is forecasting positive growth in cement consumption in the coming years. Continental Florida Materials is expected to benefit from this economic growth, in pace with the historical trend at Port Everglades.